

# INVENTORY CONTROL RACKS, BOXES AND CANISTERS

- › For All Models of Freezers and Liquid Nitrogen Storage Tanks.
- › Optimize Freezer and Liquid Nitrogen Storage Space.
- › Security Systems with Innovative Lock Devices.
- › Drawer Racks for Clinical Sample Tubes.
- › Cord Blood, Bone Marrow, Stem Cell & Plasma Bag Storage Systems.

Inventory Control System

2020 Catalog



Available in Canada from...

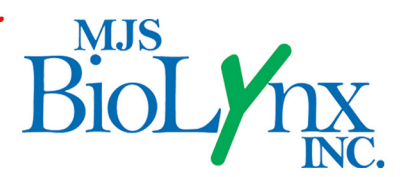

1-888-593-5969 • [www.biolynx.ca](http://www.biolynx.ca) • [tech@biolynx.ca](mailto:tech@biolynx.ca)

2020 Catalog

**\* Racks:**

*Racks fit all standard types of upright freezers, chest freezers and liquid nitrogen tanks.*

*We are pleased to offer the largest selection of freezer racks to accommodate 2", 3", 3.75", 4<sup>15</sup>/<sub>16</sub>" tall boxes, conical tubes, microtiter plates, deep-well plates, slide boxes, as well as many other storage containers.*

*Racks are constructed of high-quality, corrosion resistant stainless steel or aluminum.*

**\* Boxes and Storage:**

*Storage boxes are made of either water repellent cardboard, polycarbonate or polypropylene plastic, stainless steel or aluminum.*

*Cryogenic storage cryocanes are made of light-weight aluminum.*

**\* Security Lock Devices:**

*Security locking devices are available for all racks.*

*No tools are required for installing security lock devices.*

**\* Blood Bag, Stem Cell, Bone Marrow Storage Systems:**

*Are made with lightweight aluminum and include locking handles and thumb holes.*

*Frames are made of corrosion resistant stainless steel and includes a lifting handle.*

*Liquid nitrogen tank platform dividers are made of aluminum.*

*All stainless steel and aluminum products carry our unconditional lifetime warranty on workmanship.*

## Table of Contents















Product	Page / Line #
• Racks for Standard 2" Boxes	P4/L 1-13
• Racks for 2" Mini Boxes	P4/L 14-19
• Racks for Large 2" Cardboard Boxes	P4/L 20-21
• Racks for Standard 3" Boxes	P4/L 22-P5/L 4
• Racks for 3" Mini Boxes	P5/L 5-9
• Racks for 3.75" High Standard Boxes	P5/L 10-13
• Racks for Large 3.75" High Boxes	P5/L 14-17
• Racks for Mixed Storage of 2", 3" and 3.75" Boxes	P5/L 18-20
• Racks for 15ml & 50ml Centifuge Tube Boxes	P5/L 21-24
• Racks for Centrifuge Tubes, Blood Sample Tubes & Storage Bottles	P6/L 1-7
• Racks for 96-Well & 384-Well Microtiter Plates	P6/L 8-14
• Racks for 96-Deep Well Microtiter Plates	P6/L 15-19
• Racks for 96-Well Microtube Boxes	P6/L 20-23
• Racks for 50-Cell Hinged Top Plastic Boxes	P6/L 24-27
• Racks for 100-Cell Hinged Top Plastic Boxes	P7/L 1-4
• For Matrix Racks	P7/L 5-25
• For Micronic Racks	P8/L 1-30
• For Fluidx Racks	P9/L 1-P10/L 42
• For Abgene Racks	P11/L 1-27
• Racks for 0.2ml Tube 96-Well PCR Boxes	P12/L 1-3
• Racks for 50-Cell 0.5ml Microtube Storage Boxes	P12/L 4-6
• Racks for 50-Cell 1.5ml Microtube Storage Boxes	P12/L 7-9
• Racks for 96-Well Flipper Reversible or Multi-Boxes	P12/L 10-11
• Racks for 32/8 Flipper JR Reversible Multi-Boxes	P12/L 12-13

# Table of Contents

Product	Page & Line #
• Racks for 80-Place Tube Boxes	P12/L 14-15
• Racks for Plasma Boxes	P12/L 16-17
• Racks for 25-Place Slide Boxes	P13/L 1-4
• Racks for 100-Place Slide Boxes	P13/L 5-8
• Boxes, Cell Dividers, Label Cards	P13/L 9-17
• Cryo Canes & Stainless Steel Dewars	P13/L 18-21
• Security Lock Devices for Racks	P14/L 1-4
• Aluminum Canisters, Stainless Steel Frames for Canisters and Platform Dividers for Liquid Nitrogen Tanks	P14/L 5-10
• Work Sheet for Customized Racks	P14/L 11-14

Line No.	Product	Page
1	<b>For Standard 2" Boxes</b>	
2	<b>Stainless Steel Racks</b>	
3	* Upright Freezer Racks for 2" Boxes	21
4	* Upright Freezer Eco- Racks for Standard 2" Boxes	23
5	* Upright Freezer Drawer Racks for 2" Boxes	25
6	* Upright Sliding Tray Racks for Standard 2" Boxes	27
7	* Upright Freezer Combination Drawer Racks for 2" Boxes	29
8	& 15ml & 50ml Centrifuge Tubes	
9	* Vertical Racks for 2" Boxes	31
10	* Spring Clip Vertical Racks for 2" Boxes	32
11	* Vertical Half Racks for Standard 2" Boxes	33
12	<b>Aluminum Racks</b>	
13	* Vertical Racks for 2" Boxes	34
14	<b>For 2" Mini Boxes</b>	
15	<b>Stainless Steel Racks</b>	
16	* Mini Vertical Racks for 2" Mini Boxes	35
17	* Mini Spring Clip Vertical Racks for 2" Mini Boxes	36
18	<b>Aluminum Racks</b>	
19	* Mini Vertical Racks for 2" Mini Boxes	37
20	<b>For Large 2" Cardboard Boxes</b>	
21	* Upright Freezer Racks for Large 2" Cardboard Boxes	38
22	<b>For Standard 3" Boxes</b>	
23	<b>Stainless Steel Racks</b>	
24	* Upright Freezer Racks for 3" Boxes	39
25	* Upright Freezer Eco-Rack for Standard 3" Boxes	40
26	* Upright Freezer Drawer Racks for 3" Boxes	41
27	* Upright Sliding Tray Racks for Standard 3" Boxes	42
28	* Vertical Racks for 3" Boxes	43



(Continued on next page)

Line No.	Product	Page
1	* Spring Clip Vertical Racks for 3" Boxes 	44
2	* Vertical Half Racks for Standard 3" Boxes 	45
3	<b>Aluminum Racks</b>	
4	* Vertical Racks for 3" Boxes 	46
<b>For 3" Mini Boxes</b>		
6	<b>Stainless Steel Racks</b>	
7	* Mini Vertical Racks for 3" Mini Boxes 	47
8	<b>Aluminum Racks</b>	
9	* Mini Vertical Racks for 3" Mini Boxes 	48
<b>For 3.75" High Standard Boxes</b>		
11	* Upright Freezer Racks for 3.75" High Standard Boxes 	49
12	* Upright Freezer Drawer Racks for 3.75" High Standard Boxes 	50
13	* Vertical Racks for 3.75" High Standard Boxes 	51
<b>For Large 3.75" High Boxes</b>		
15	* Upright Freezer Racks for Large 3.75" High Boxes 	51
16	* Upright Freezer Drawer Racks for Large 3.75" High Boxes 	52
17	* Vertical Racks for Large 3.75" High Boxes 	52
<b>For Standard 2", 3" and 3.75" Boxes</b>		
19	* Modifiable Upright Freezer Racks 	53
20	* Upright Freezer Racks for Mixed Storage of 2", 3" and 3.75" Boxes	53
<b>For 15ml &amp; 50 Centifuge Tube Boxes</b>		
22	<b>Stainless Steel Racks</b>	
23	* Upright Freezer Racks for 15ml & 50ml Centrifuge Tube Boxes 	54
23	* Vertical Freezer Racks for 15ml & 50ml Centrifuge Tube Boxes 	54

Line No.	Product	Page
1	<b>For Centrifuge Tubes, Blood Sample Tubes &amp; Storage Bottles</b>	
2	<b>Stainless Steel Racks</b>	
3	* Upright Freezer Drawer Racks for Centrifuge Tubes 	55
4	* Upright Freezer Drawer Racks for Storage Bottles 	56
5	* Mixed Use Storage Bins with Lids 	57
6	* Mixed Use Storage Drawers with Lids 	58
7	* Upright Freezer Drawer Racks for Blood Sample Tubes 	59
<b>For 96-Well &amp; 384-Well Microtiter Plates</b>		
9	<b>Stainless Steel Racks</b>	
10	* Upright Freezer Racks for 96-Well & 384-Well	
11	Microtiter Plates 	60
12	* Upright Freezer Drawer Racks for 96-Well & 384-Well	
13	Microtiter Plates 	61
14	* Vertical Freezer Racks for 96 - Well & 384-Well Microtiter Plates 	62
<b>For 96-Deep Well Microtiter Plates</b>		
16	<b>Stainless Steel Racks</b>	
17	* Upright Freezer Racks for 96 Deep-Well Microtiter Plates 	63
18	* Upright Freezer Drawer Racks for 96 Deep-Well Microtiter Plates 	64
19	* Vertical Freezer Racks for 96 Deep-Well Microtiter Plates 	65
<b>For 96-Well Microtube Boxes</b>		
21	* Upright Freezer Racks for 96-Well Microtube Boxes 	66
22	* Upright Freezer Drawer Racks for 96-Well Microtube Boxes 	67
23	* Vertical Racks for 96-Well Microtube Boxes 	68
<b>For 50-Cell Hinged Top Plastic Boxes</b>		
25	* Upright Freezer Racks for 50-Cell Hinged Top Plastic Boxes 	69
26	* Upright Drawer Racks for 50-Cell Hinged Top Plastic Boxes 	70
27	* Vertical Racks for 50-Cell Hinged Top Plastic Boxes 	71

Line No.	Product	Page
1	<b>For 100-Cell Hinged Top Plastic Storage Boxes</b>	
2	* Upright Freezer Racks for 100-Cell Hinged Top Plastic Storage Boxes 	72
3	* Upright Freezer Drawer Racks for 100-Cell Hinged Top Plastic Storage Boxes 	73
4	* Vertical Racks for 100-Cell Hinged Top Plastic Storage Boxes 	74
5	<b>For Matrix Racks</b>	
6	<b>Upright Freezer Racks</b> 	
7	* For 500ul (0.5ml) Matrix Trackmate Latch Rack	75
8	* For Matrix 500ul Screw-Top Latch Rack	77
9	* For Matrix 0.75ml Latch Rack	77
10	* For Matrix 1.4ml Latch Rack	78
11	* For Matrix 1.0ml Screw-Top Latch Rack	79
12	* For Matrix 12ml Screw-Top Latch Rack	80
13	<b>Upright Freezer Drawer Racks</b> 	
14	* For 500ul (0.5ml) Matrix Trackmate Latch Rack	81
15	* For Matrix 500ul Screw-Top Latch Rack	83
16	* For Matrix 0.75ml Latch Rack	83
17	* For Matrix 1.4ml Latch Rack	84
18	* For Matrix 1.0ml Screw-Top Latch Rack	85
19	<b>Vertical Racks</b> 	
20	* For 500ul (0.5ml) Matrix Trackmate Latch Rack	86
21	* For Matrix 500ul Screw-Top Latch Rack	88
22	* For Matrix 0.75ml Latch Rack	88
23	* For Matrix 1.4 ml Latch Rack	89
24	* For Matrix 1.0ml Screw-Top Latch Rack	90
25	* For Matrix 12ml Screw-Top Latch Rack	91

(Continued on next page)

Line No.	Product	Page
1	<b>For Micronic Racks</b>	
2	<b>Upright Freezer Racks</b> 	
3	* For Micronic Loborack-96 with Low Cover	75
4	* For Micronic Loborack-96 with Standard Cover	76
5	* For Micronic Loborack-96 with High Cover	76
6	* For Micronic Roborack-96 with Low Cover	77
7	* For Micronic Roborack-96 with Standard Cover	78
8	* For Micronic Comorack-96	78
9	* For Micronic Comorack-24	78
10	* For Micronic Roborack-96 with High Cover	79
11	* For Micronic Roborack-96 with Extra High Cover	80
12	<b>Upright Freezer Drawer Racks</b> 	
13	* For Micronic Loborack-96 with Low Cover	81
14	* For Micronic Loborack-96 with Standard Cover	82
15	* For Micronic Loborack-96 with High Cover	82
16	* For Micronic Roborack-96 with Low Cover	83
17	* For Micronic Roborack-96 with Standard Cover	84
18	* For Micronic Comorack-96	84
19	* For Micronic Comorack-24	84
20	* For Micronic Roborack-96 with High Cover	85
21	<b>Vertical Racks</b> 	
22	* For Micronic Loborack-96 with Low Cover	86
23	* For Micronic Loborack-96 with Standard Cover	87
24	* For Micronic Loborack-96 with High Cover	87
25	* For Micronic Roborack-96 with Low Cover	88
26	* For Micronic Roborack-96 with Standard Cover	87
27	* For Micronic Comorack-96	89
28	* For Micronic Comorack-24	89
29	* For Micronic Roborack-96 with High Cover	90
30	* For Micronic Roborack-96 with Extra High Cover	91

(Continued on next page)

Line No.	Product	Page
1	<b>For Fluidx Racks</b>	
2	<b>Upright Freezer Racks</b> 	
3	* For Fluidx Low Profile 96-Format Rack for all 0.5ml and 0.75ml Tube with Low Profile Lid	75
4		
5	* For Fluidx Low profile 96-Format Rack for all 0.5ml and 0.75ml Tube with Standard Profile Lid	76
6		
7	* For Fluidx 96-Format Rack for Tube with Protective Jacket with Low Cover	76
8	* For Fluidx 384-Format Rack for Square Tube	77
9	* For Fluidx Low Profile 96-Format Rack for all 0.5ml and 0.75ml Tube with Tall Profile Lid	77
10		
11	* For Fluidx 96-Format Rack for 1.0ml Tube with Low Profile Lid	77
12	* For Fluidx 96-Format Rack for Tube with Protective Jacket with Standard Profile Lid	77
13		
14	* For Fluidx 384-Format Rack for Round Tube	78
15	* For Fluidx 96-Format Rack for 1.0ml and 1.4ml Tube with Standard Profile Lid	78
16		
17	* For Fluidx 48-Format Rack for Cryo Tube with Standard Profile Lid	78
18	* For Fluidx 48-Format Rack for Glass Tube	78
19	* For Fluidx 96-Format Rack for Tube with Protective Jacket with Tall Profile Lid	79
20		
21	* For Fluidx 24-Format Rack	79
22	* For Fluidx 96-Format Rack for 1.0ml and 1.4ml Tube with Tall Profile Lid	79
23		
24	* For Fluidx 48-Format Rack for Cryo Tube with Tall Profile Lid	80
25	<b>Upright Freezer Drawer Racks</b> 	
26	* For Fluidx Low Profile 96-Format Rack for all 0.5ml and 0.75ml Tube with Low Profile Lid	81
27		
28	* For Fluidx Low profile 96-Format Rack for all 0.5ml and 0.75ml Tube with Standard Profile Lid	82
29		
30	* For Fluidx 96-Format Rack for Tube with Protective Jacket with Low Cover	82
31		
32	* For Fluidx 384-Format Rack for Square Tube	83
33	* For Fluidx Low Profile 96-Format Rack for all 0.5ml and 0.75ml Tube with Tall Profile Lid	83
34		

(Continued on next page)

Line No.	Product	Page
1	* For Fluidx 96-Format Rack for 1.0ml Tube with Low Profile Lid	83
2		
3	* For Fluidx 96-Format Rack for Tube with Protective Tube and Standard Profile Lid	83
4		
5	* For Fluidx 384-Format Rack for Round Tube	84
6	* For Fluidx 96-Format Rack for 1.0ml and 1.4ml Tube with Standard Profile Lid	84
7		
8	* For Fluidx 48-Format Rack for Cryo Tube with Standard Profile Lid	84
9		
10	* For Fluidx 48-Format Rack for Glass Tube	84
11	* For Fluidx 96-Format Rack for Tube with Protective Jacket with Tall Profile Lid	85
12		
13	* For Fluidx 24-Format Rack	85
14	* For Fluidx 96-Format Rack for 1.0ml and 1.4ml Tube with Tall Profile Lid	85
15		
16	<b>Vertical Racks</b> 	
17	* For Fluidx Low Profile 96-Format Rack for all 0.5ml and 0.75ml Tube with Low Profile Lid	86
18		
19	* For Fluidx Low profile 96-Format Rack for all 0.5ml and 0.75ml Tube with Standard Profile Lid	87
20		
21	* For Fluidx 96-Format Rack for Tube with Protective Jacket with Low Cover	87
22		
23	* For Fluidx 384-Format Rack for Square Tube	88
24	* For Fluidx Low Profile 96-Format Rack for all 0.5ml and 0.75ml Tube with Tall Profile Lid	88
25		
26	* For Fluidx 96-Format Rack for 1.0ml Tube with Low Profile Lid	88
27		
28	* For Fluidx 96-Format Rack for Tube with Protective Jacket with Standard Profile Lid	88
29		
30	* For Fluidx 384-Format Rack for Round Tube	89
31	* For Fluidx 96-Format Rack for 1.0ml and 1.4ml Tube with Standard Profile Lid	89
32		
33	* For Fluidx 48-Format Rack for Cryo Tube with Standard Profile Lid	89
34		
35	* For Fluidx 48-Format Rack for Glass Tube	89
36	* For Fluidx 96-Format Rack for Tube with Protective Jacket with Tall Profile Lid	90
37		
38	* For Fluidx 24-Format Rack	90
39	* For Fluidx 96-Format Rack for 1.0ml and 1.4ml Tube with Tall Profile Lid	90
40		
41	* For Fluidx 48-Format Rack for Cryo Tube with Tall Profile Lid	91
42		

(Continued on next page)

Line No.	Product	Page
1	<b>For Abgene Racks</b>	
2	<b>Upright Freezer Racks</b>	
3 *	For Abgene 0.3ml 2D Barcoded Storage Rack	75
4 *	For Abgene 0.5ml 2D Barcoded Twist Lock Storage Rack	76
5 *	For Abgene 0.6ml 2D Barcoded Storage Rack	76
6 *	For Abgene 2.0ml 2D Barcoded Screw Cap Storage Rack	78
7 *	For Abgene 1.0ml 2D Barcoded Twist Lock Storage Rack	78
8 *	For Abgene 1.2ml 2D Barcoded Tube in Stackable Rack	79
9 *	For Abgene 1.2ml 2D Barcoded Storage Rack	79
10 *	For Abgene 5.0ml 2D Barcoded Screw Cap Storage Rack	80
11	<b>Upright Freezer Drawer Racks</b>	
12 *	For Abgene 0.3ml 2D Barcoded Storage Rack	81
13 *	For Abgene 0.5ml 2D Barcoded Twist Lock Storage Rack	82
14 *	For Abgene 0.6ml 2D Barcoded Storage Rack	82
15 *	For Abgene 2.0ml 2D Barcoded Screw Cap Storage Rack	84
16 *	For Abgene 1.0ml 2D Barcoded Twist Lock Storage Rack	84
17 *	For Abgene 1.2ml 2D Barcoded Tube in Stackable Rack	85
18 *	For Abgene 1.2ml 2D Barcoded Storage Rack	85
19	<b>Vertical Racks</b>	
20 *	For Abgene 0.3ml 2D Barcoded Storage Rack	86
21 *	For Abgene 0.5ml 2D Barcoded Twist Lock Storage Rack	87
22 *	For Abgene 0.6ml 2D Barcoded Storage Rack	87
23 *	For Abgene 2.0ml 2D Barcoded Screw Cap Storage Rack	89
24 *	For Abgene 1.0ml 2D Barcoded Twist Lock Storage Rack	89
25 *	For Abgene 1.2ml 2D Barcoded Tube in Stackable Rack	90
26 *	For Abgene 1.2ml 2D Barcoded Storage Rack	90
27 *	For Abgene 5.0ml 2D Barcoded Screw Cap Storage Rack	91





(Continued on next page)

Line No.	Product	Page
1	<b>For 0.2ml Tube 96-Well PCR Boxes</b>	
2 *	Upright Freezer Racks for 0.2ml Tube 96-Well PCR Boxes	92
3 *	Upright Drawer Racks 0.2ml Tube 96-Well PCR Boxes	93
4	<b>For 50-Cell 0.5ml Microtube Storage Boxes</b>	
5 *	Upright Freezer Racks for 50-Cell 0.5ml Microtube Storage Boxes	94
6 *	Chest Freezer Racks 50-Cell 0.5ml Microtube Storage Boxes	95
7	<b>For 50-Cell 1.5ml Microtube Storage Boxes</b>	
8 *	Upright Freezer Racks for 50-Cell 1.5ml Microtube Storage Boxes	96
9 *	Chest Freezer Racks 50-Cell 1.5ml Microtube Storage Boxes	97
10	<b>For 96-Well Flipper Reversible or Multi-Boxes</b>	
11 *	Upright Freezer Racks for 96-Well Flipper Reversible Boxes	98
12	<b>For 32/8 Flipper JR Reversible Multi-Boxes</b>	
13 *	Upright Freezer Racks for 32/8 Flipper JR Reversible Multi-Boxes	99
14	<b>For 80-Place Tube Boxes</b>	
15 *	Upright Freezer Racks for 80-Place Tube Boxes	100
16	<b>Racks for Plasma Boxes</b>	
17 *	Upright Freezer Racks for Plasma Boxes	101

(Continued on next page)

Line No.	Product	Page
1	<b>For 25-Place Slide Boxes</b>	
2	* Upright Freezer Racks for 25-Place Slide Boxes 	102
3	* Upright Freezer Drawer Racks for 25-Place Slide Boxes 	103
4	* Chest Freezer Racks for 25-Place Slide Boxes 	104
5	<b>For 100-Place Slide Boxes</b>	
6	* Upright Freezer Racks for 100-Place Slide Boxes 	105
7	* Upright Freezer Drawer Racks for 100-Place Slide Boxes 	106
8	* Chest Freezer Racks for 100-Place Slide Boxes 	107
9	<b>Boxes, Cell Dividers, Label Cards</b>	
10	* Cardboard Boxes 	108
11	* Standard Box Dividers for Cardboard and Metal Boxes 	109
12	* Polycarbonate Boxes 	110
13	* Polypropylene Boxes 	110
14	* 100-Cell Hinged Plastic Boxes 	110
15	* Metal Boxes 	111
16	* Label Cards for Drawer Racks 	111
17	* Metal Tags for Freezer Racks 	112
18	<b>Cryo Canes, Vacuum Flasks</b>	
19	* Aluminum Cryo Canes 	112
20	* Metal Tags for Aluminum Cryo Canes 	112
21	* Stainless Steel Dewar Flasks 	112

(Continued on next page)

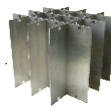









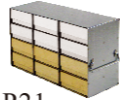









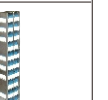
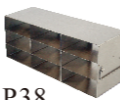















Line No.	Product	Page
1	<b>Security Lock Devices for Racks</b>	
2	* Security Lock Devices for Chest Freezer & Liquid Nitrogen Tank Racks 	113
3	* Security Lock Devices for Upright Freezer Racks 	115
4	* Security Lock Devices for Upright Freezer Drawer Racks 	117
5	<b>Aluminum Canisters, Stainless Steel Frames for Canisters and Platform Dividers for Liquid Nitrogen Tanks</b>	
7	* Aluminum Blood Bag Canisters 	119
8	* Stainless Steel Canister Frames 	121
9	* Aluminum Platform Dividers for Liquid Nitrogen Storage Tanks 	124
10	* Complete Blood Bag Storage Systems for Liquid Nitrogen Freezer Tanks	128
11	<b>Work Sheet for Customized Racks</b>	
12	* For Upright Freezer Racks	132
13	* For Upright Freezer Drawer Racks	133
14	* For Vertical Racks	134

(Continued on next page)



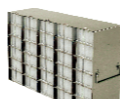

# Index Table for Freezer Racks

## Index Table for Freezer Racks







	Upright Freezer Racks	Modifiable Upright Freezer Racks	Upright Freezer Eco-Racks	Upright Freezer Drawer Racks	Upright Freezer Sliding Tray Racks	Vertical Racks			
						Stainless Steel			Aluminum
						Standard	Spring Clip	Vertical Half Racks	
For Standard 2" Boxes	 P21	 P53	 P23	 P25	 P27	 P31	 P32	 P33	 P34
For 2" Mini Boxes	N/A	N/A	N/A	N/A	N/A	 P35	 P36	N/A	 P37
For Large 2" Cardboard Boxes	 P38	N/A	N/A	N/A	N/A	N/A	N/A	N/A	N/A
For Standard 3" Boxes	 P39	 P53	 P40	 P41	 P42	 P43	 P44	 P45	 P46
For 3" Mini Boxes	N/A	N/A	N/A	N/A	N/A	 P47	N/A	N/A	 P48
For 3.75" High Standard Boxes	 P49	N/A	N/A	 P50	N/A	 P51	N/A	N/A	N/A
For Large 3.75" High Boxes	 P51	N/A	N/A	 P52	N/A	 P52	N/A	N/A	N/A
For 15ml & 50ml Centrifuge Boxes	 P54	N/A	N/A	N/A	N/A	 P54	N/A	N/A	N/A
For Centrifuge Tubes, Blood Sample Tubes & Storage Bottles	N/A	N/A	N/A	 P55/P56/P59	N/A	N/A	N/A	N/A	N/A
For 96-Well & 384-Well Microtiter Plates	 P60	N/A	N/A	 P61	N/A	 P62	N/A	N/A	N/A
For 96-Deep Well Microtiter Plates	 P63	N/A	N/A	 P64	N/A	 P65	N/A	N/A	N/A

(Continued on next page)



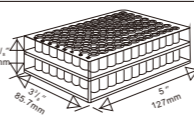
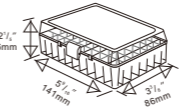
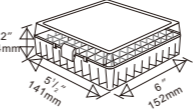
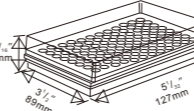
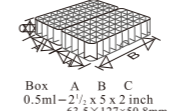
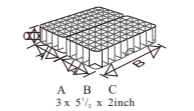
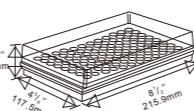
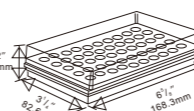
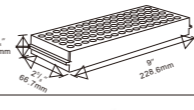

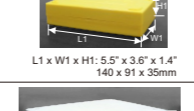



## Index Table for Freezer Racks

		Upright Freezer Racks	Upright Freezer Drawer Racks	Vertical Racks Standard
				
<b>For MATRIX</b> Dimensions: L(127.76)XW(85.48)XH(0)mm	500ul(0.5ml) Latch Rack(H=27.48mm / 1 <sup>1</sup> / <sub>16</sub> inch)	P75	P81	P86
	500ul(0.5ml) Screw-Top Latch Rack (H=44.32mm / 1 <sup>3</sup> / <sub>4</sub> inch)	P77	P83	P88
	0.75ml Latch Rack (H=39.37mm / 1 <sup>1</sup> / <sub>2</sub> inch)	P77	P83	P88
	1.4ml Latch Rack (H=49.84mm / 1 <sup>5</sup> / <sub>16</sub> inch)	P78	P84	P89
	1.0ml Screw-Top Latch Rack (H=58.42 mm / 2 <sup>5</sup> / <sub>16</sub> inch)	P79	P85	P90
	12ml Screw-Top Latch Rack (H=107.82mm / 4 <sup>1</sup> / <sub>4</sub> inch)	P80		P91
<b>For Micronic</b> Dimensions: L(127.76)XW(85.48)XH(0)mm	Micronic Lobarack-96 with Low Cover (H=23.8mm / <sup>15</sup> / <sub>16</sub> inch)	P75	P81	P86
	Micronic Lobarack-96 with Standard Cover (H=31.7mm / 1 <sup>1</sup> / <sub>4</sub> inch)	P76	P82	P87
	Micronic Lobarack-96 with High Cover (H=38.7mm / 1 <sup>1</sup> / <sub>2</sub> inch)	P76	P82	P87
	Micronic Robarack-96 with Low Cover (H=41.2mm / 1 <sup>5</sup> / <sub>8</sub> inch)	P77	P83	P88
	Micronic Robarack-96 with Standard Cover (H=49.1mm / 1 <sup>5</sup> / <sub>16</sub> inch)	P78	P84	P89
	Micronic Comorack-96 (H=52mm / 2 inch)	P78	P84	P89
	Micronic Comorack-24 (H=52mm / 2 inch)	P78	P84	P89
	Micronic Robarack-96 with High Cover (H=56.1mm / 2 <sup>1</sup> / <sub>4</sub> inch)	P79	P85	P90
	Micronic Robarack-96 with Extra High Cover (H=88mm / 3 <sup>1</sup> / <sub>2</sub> inch)	P80		P91
	<b>For Fluidx</b> Dimensions: L(127.76)XW(85.48)XH(0)mm	Low Profile 96-Format Rack for all 0.5ml and 0.75ml Tubes with Low Profile Lid (H=26.0mm / 1 inch)	P75	P81
Low Profile 96-Format Rack for all 0.5ml and 0.75ml Tube with Standard Profile Lid (H=32.9mm / 1 <sup>5</sup> / <sub>16</sub> inch)		P76	P82	P87
Low Profile 96-Format Rack for Tube with Protective Jacket with Profile Lid (H=38mm / 1 <sup>1</sup> / <sub>2</sub> inch)		P76	P82	P87
384-Format Rack for Square Tube (H=14.4mm / <sup>1</sup> / <sub>2</sub> inch)		P77	P83	P88
Low Profile 96-Format Rack for all 0.5ml and 0.75ml Tube with Tall Profile Lid (H=43.87mm / 1 <sup>3</sup> / <sub>4</sub> inch)		P77	P83	P88
96-Format Tube Rack for 1.0ml Tube with Low Profile Lid (H=43.9mm / 1 <sup>3</sup> / <sub>4</sub> inch)		P77	P83	P88
96-Format Racks for Tube with Protective Jacket with Standard Profile Lid (H=44mm / 1 <sup>3</sup> / <sub>4</sub> inch)		P77	P83	P88
384-Format Rack for Round Tube (H=17.3mm / <sup>5</sup> / <sub>2</sub> inch)		P78	P84	P89
96-Format Tube Rack for 1.0ml and 1.4ml Tubes with Standard Profile Lid(H=50.8mm / 2 inch)		P78	P84	P89
48-Format Rack for Cryo Tube with Standard Profile Lid (H=52.8mm / 2 <sup>1</sup> / <sub>16</sub> inch)		P78	P84	P89
48-Format Rack for Glass Tube (H=51.6mm / 2inch)		P78	P84	P89
96-Format Rack for Tube with Protective Jacket with Tall Profile Lid (H=55mm / 2 <sup>3</sup> / <sub>16</sub> inch)		P79	P85	P90
24-Format Rack (H=56mm / 2 <sup>1</sup> / <sub>4</sub> inch)		P79	P85	P90
96-Format Tube Rack for 1.0ml and 1.4ml Tube with Tall Profile Lid (H=61.8mm / 2 <sup>7</sup> / <sub>16</sub> inch)		P79	P85	P90
48-Format Rack for Cryo Tube with Tall Profile Lid (H=88.5mm / 3 <sup>1</sup> / <sub>2</sub> inch)		P80		P91
<b>For Abgene</b> Dimensions: L(127.76)XW(85.48)XH(0)mm		0.3ml 2D Barcoded Storage Rack (H=28.45mm / 1 <sup>1</sup> / <sub>8</sub> inch)	P76	P82
	0.5ml 2D Barcoded Twist Lock Storage Tube Rack (H=38.5mm / 1 <sup>1</sup> / <sub>2</sub> inch)	P76	P82	P87
	0.6ml 2D Barcoded Storage Tube Rack(H=38.5mm / 1 <sup>1</sup> / <sub>2</sub> inch)	P78	P84	P89
	2.0ml 2D Barcoded Screw Cap Storage Tube Rack (H=52.5mm / 2 <sup>1</sup> / <sub>16</sub> inch)	P78	P84	P89
	1.0ml 2D Barcoded Twist Lock Storage Tube Rack (H=53.5mm / 1 <sup>1</sup> / <sub>8</sub> inch)	P77	P83	P88
	1.2ml 2D Barcoded Tube in Stackable Rack (H=56.13mm / 2 <sup>1</sup> / <sub>4</sub> inch)	P79	P85	P90
	1.2ml 2D Barcoded Storage Tube Rack (H=56.21mm / 2 <sup>1</sup> / <sub>4</sub> inch)	P79	P85	P90
5.0ml 2D Barcoded Screw Cap Storage Tube Rack (H=101.5mm / 4inch)	P80		P91	

## Index Table for Freezer Racks

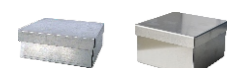
	Dimension	Upright Freezer Racks	Upright Freezer Drawer Racks	Vertical Racks Standard
				
For 96-Well Microtube Boxes		P66	P67	P68
For 50-Cell Hinged Top Plastic Boxes		P69	P70	P71
For 100-Cell Hinged Top Plastic Storage Boxes		P72	P73	P74
For 0.2ml Tube 96-Well PCR Boxes		P92	P93	N/A
For 50-Cell 0.5ml Microtube Storage Boxes		P94	N/A	P95
For 50-Cell 1.5ml Microtube Storage Boxes		P96	N/A	P97
For 96-Well Flipper Reversible or Multi-Box		P98	N/A	N/A
For 32/8 Flipper JR Reversible Multi-box		P99	N/A	N/A
For 80-Place Tube Box		P100	N/A	N/A
Upright Rack For Plasma Boxes		P101	N/A	N/A
For 25-Place Slide Boxes		P102	P103	P104
For 100-Place Small Slide Boxes		P105	P106	P107

(Continued on next page)

<b>Cardboard Boxes &amp; Standard Box Dividers</b>  P109	<b>Polycarbonate Boxes</b>  P110	<b>Polypropylene Boxes</b>  P110	<b>100-Cell Hinged Plastic Boxes</b>  P110
<b>Metal Boxes</b>  P111	<b>Rack Label &amp; Identification Card</b>  P111	<b>Cryo-Canes</b>  P112	<b>Dewar Flasks</b>  P112

**Index Table for Canisters & Frames**

Bag	Cannisters	Frames for Cannisters	
BAXTER/FENWAL	P119 		P121
STERICON	P119 		P121
CHARTERMED	P119 		P121
GAMBRO	P119 		P121
MED SEP	P119 		P121

**Index Table for Security Lock Devices for Racks**

Rack Style	Security Lock Device
Vertical Rack for Chest Freezer & Liquid Nitrogen Tanks	 P113
Upright Freezer Rack	 P115
Upright Freezer Drawer Rack	 P117

**Index Table for Platform Dividers for Liquid Nitrogen Tanks**

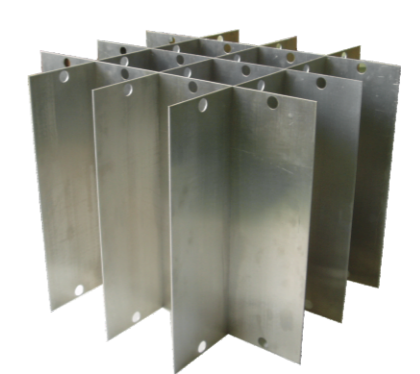
Freezer Internal Diameter inches (cm)	Platform Dividers h=20" (50.8cm)	
20" (50.8cm)		P124
24" (61cm)		
31" (78.7cm)		
39" (99cm)		

# Upright Freezer Racks

## For Standard 2" Boxes

- ◆ Racks are for standard 2" cardboard (white or yellow), plastic (polypropylene or polycarbonate) or metal (stainless or aluminum) boxes.
- ◆ Constructed of corrosion resistant stainless steel.
- ◆ Security lock devices are available for each rack.

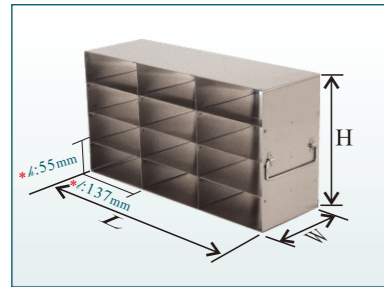

Rack Only

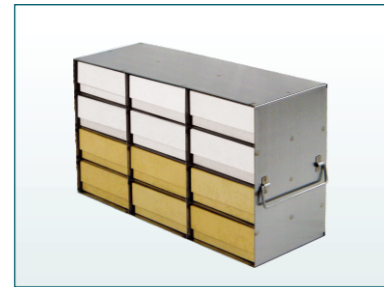

Rack w/Cardboard Box



Rack w/Metal Box



Rack w/Polycarbonate Plastic Box



w/DP Lock Device Option

\* UF-262 / UF-362 / UF-462 / UF-562 (4:51mm), fitted with 2" cardboard box.



Yellow 2" Cardboard Box



White 2" Cardboard Box

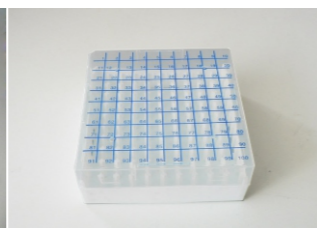

Polycarbonate Plastic Box



Metal Box  
S-Stainless Steel  
A-Aluminum

[ Check page 108 for Boxes ]

Part Number	Description	Dimension L x H x W	Capacity (Box)	Lock Device Option***	Shipping Weight lb(Kg)
UF-222	Rack Only	11 1/2 x 4 1/2 x 5 1/2 inch 292 x 114 x 140 mm	2 x 2 =4	DP-1005	2.3(1.04)
UF-222-W-XX**	Rack w/2" box and divider				2.3(1.04)+4*ω <sup>1</sup>
UF-232	Rack Only	11 1/2 x 6 3/8 x 5 1/2 inch 292 x 169 x 140 mm	2 x 3 =6	DP-1007	3.1(1.40)
UF-232-W-XX**	Rack w/2" box and divider				3.1(1.40)+6*ω <sup>1</sup>

(Continued on next page)

# Upright Freezer Racks

## For Standard 2" Boxes

Part Number	Description	Dimension L x H x W	Capacity (Box)	Lock Device Option***	Shipping Weight lb(Kg)
UF-242	Rack Only	11 1/2 x 8 7/8 x 5 1/2 inch 292 x 225 x 140 mm	2 x 4 =8	DP-1009	3.9(1.76)
UF-242-W-XX**	Rack w/2" box and divider				3.9(1.76)+6*ω <sup>1</sup>
UF-252	Rack Only	11 1/2 x 11 x 5 1/2 inch 292 x 280 x 140 mm	2 x 5 =10	DP-1011	4.5(2.06)
UF-252-W-XX**	Rack w/2" box and divider				4.5(2.06)+10*ω <sup>1</sup>
UF-262	Rack Only	11 1/2 x 12 3/8 x 5 1/2 inch 292 x 321 x 140 mm	2 x 6 =12	DP-1013	5.2(2.35)
UF-262-W-XX**	Rack w/2" cardboard box and divider				5.2(2.35)+10*ω <sup>1</sup>
UF-272	Rack Only	11 1/2 x 15 3/8 x 5 1/2 inch 292 x 391 x 140 mm	2 x 7 =14	DP-1015	6.0(2.72)
UF-272-W-XX**	Rack w/2" box and divider				6.0(2.72)+14*ω <sup>1</sup>
UF-332	Rack Only	16 7/8 x 6 3/8 x 5 1/2 inch 429 x 168 x 140 mm	3 x 3 =9	DP-1607	4.3(1.97)
UF-332-W-XX**	Rack w/2" box and divider				4.3(1.97)+9*ω <sup>1</sup>
UF-342	Rack Only	16 7/8 x 8 7/8 x 5 1/2 inch 429 x 225 x 140 mm	3 x 4 =12	DP-1609	5.5(2.49)
UF-342-W-XX**	Rack w/2" box and divider				5.5(2.49)+12*ω <sup>1</sup>
UF-352	Rack Only	16 7/8 x 11 x 5 1/2 inch 429 x 280 x 140 mm	3 x 5 =15	DP-1611	6.6(2.97)
UF-352-W-XX**	Rack w/2" box and divider				6.6(2.97)+15*ω <sup>1</sup>
UF-362	Rack Only	16 7/8 x 12 5/8 x 5 1/2 inch 429 x 321 x 140 mm	3 x 6 =18	DP-1613	7.5(3.38)
UF-362-W-XX**	Rack w/2" cardboard box and divider				7.5(3.38)+18*ω <sup>1</sup>
UF-372	Rack Only	16 7/8 x 15 3/8 x 5 1/2 inch 429 x 391 x 140 mm	3 x 7 =21	DP-1615	8.5(3.87)
UF-372-W-XX**	Rack w/2" box and divider				8.5(3.87)+21*ω <sup>1</sup>
UF-432	Rack Only	22 3/16 x 6 3/8 x 5 1/2 inch 564 x 168 x 140 mm	4 x 3 =12	DP-2107	5.8(2.62)
UF-432-W-XX**	Rack w/2" box and divider				5.8(2.62)+12*ω <sup>1</sup>
UF-442	Rack Only	22 3/16 x 8 7/8 x 5 1/2 inch 564 x 225 x 140 mm	4 x 4 =16	DP-2109	7.1(3.23)
UF-442-W-XX**	Rack w/2" box and divider				7.1(3.23)+16*ω <sup>1</sup>
UF-452	Rack Only	22 3/16 x 11 x 5 1/2 inch 564 x 280 x 140 mm	4 x 5 =20	DP-2111	8.5(3.86)
UF-452-W-XX**	Rack w/2" box and divider				8.5(3.86)+20*ω <sup>1</sup>
UF-462	Rack Only	22 3/16 x 12 5/8 x 5 1/2 inch 564 x 321 x 140 mm	4 x 6 =24	DP-2113	9.7(4.38)
UF-462-W-XX**	Rack w/2" cardboard box and divider				9.7(4.38)+24*ω <sup>1</sup>
UF-472	Rack Only	22 3/16 x 15 3/8 x 5 1/2 inch 564 x 391 x 140 mm	4 x 7 =28	DP-2115	11.2(5.06)
UF-472-W-XX**	Rack w/2" box and divider				11.2(5.06)+28*ω <sup>1</sup>
UF-482	Rack Only	22 3/16 x 17 3/8 x 5 1/2 inch 564 x 447 x 140 mm	4 x 8 =32	DP-2117	13.4(6.10)
UF-482-W-XX**	Rack w/2" box and divider				13.4(6.10)+32*ω <sup>1</sup>
UF-532	Rack Only	27 5/16 x 6 3/8 x 5 1/2 inch 693 x 168 x 140 mm	5 x 3 =15	DP-2707	7.0(3.18)
UF-532-W-XX**	Rack w/2" box and divider				7.0(3.18)+15*ω <sup>1</sup>
UF-542	Rack Only	27 5/16 x 8 7/8 x 5 1/2 inch 693 x 225 x 140 mm	5 x 4 =20	DP-2709	8.6(3.91)
UF-542-W-XX**	Rack w/2" box and divider				8.6(3.91)+20*ω <sup>1</sup>
UF-552	Rack Only	27 5/16 x 11 x 5 1/2 inch 693 x 280 x 140 mm	5 x 5 =25	DP-2711	10.3(4.66)
UF-552-W-XX**	Rack w/2" box and divider				10.3(4.66)+25*ω <sup>1</sup>
UF-562	Rack Only	27 5/16 x 12 5/8 x 5 1/2 inch 693 x 321 x 140 mm	5 x 6 =30	DP-2715	11.7(5.32)
UF-562-W-XX**	Rack w/2" cardboard box and divider				11.7(5.32)+30*ω <sup>1</sup>
UF-572	Rack Only	27 5/16 x 15 3/8 x 5 1/2 inch 693 x 391 x 140 mm	5 x 7 =35	DP-2717	13.5(6.14)
UF-572-W-XX**	Rack w/2" box and divider				13.5(6.14)+35*ω <sup>1</sup>

\* To order, replace XX with either 81 or 100 cell divider.

\*\* Lock device is ordered separately.

\*\*\* ω<sup>1</sup>=0.22lb(0.1kg) for cardboard box, 0.37lb(0.17kg) for plastic box, 0.84lb(0.38kg) for stainless steel box, 0.53lb(0.24kg) for aluminum box.

\*\*\*\* UF-262, UF-362, UF-462, UF-562, can be fitted with 2" cardboard box only, not applied to plastic box.

# Upright Freezer Eco-Racks

## For Standard 2" Boxes

- ◆ Designed economically for best cost performance.
- ◆ For standard 2" cardboard (white or yellow), plastic (polypropylene or polycarbonate) or metal (stainless or aluminum) boxes.
- ◆ Constructed of corrosion resistant stainless steel.

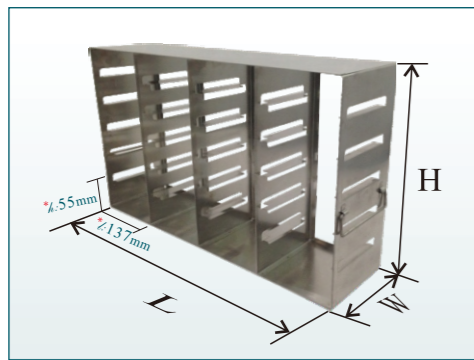

Rack Only



Rack w/Cardboard Box



Yellow 2" Cardboard Box

White 2" Cardboard Box

Polycarbonate Plastic Box

Metal Box  
S-Stainless Steel  
A-Aluminum

[ Check page 108 for Boxes ]

# Upright Freezer Eco-Racks

## For Standard 2" Boxes

Part Number	Description	Dimension L x H x W	Capacity (Box)	Lock Device Option***	Shipping Weight lb(Kg)
UFE-332	Rack Only	16 <sup>13</sup> / <sub>16</sub> x 6 <sup>5</sup> / <sub>8</sub> x 5 <sup>1</sup> / <sub>2</sub> inch 427 x 168 x 140 mm	3 x 3 =9	DP-1607	3.1(1.42)
UFE-342	Rack Only	16 <sup>13</sup> / <sub>16</sub> x 8 <sup>7</sup> / <sub>8</sub> x 5 <sup>1</sup> / <sub>2</sub> inch 427 x 225 x 140 mm	3 x 4 =12	DP-1609	3.6(1.62)
UFE-352	Rack Only	16 <sup>13</sup> / <sub>16</sub> x 11 x 5 <sup>1</sup> / <sub>2</sub> inch 427 x 280 x 140 mm	3 x 5 =15	DP-1611	3.9(1.79)
UFE-362	Rack Only	16 <sup>13</sup> / <sub>16</sub> x 12 <sup>5</sup> / <sub>8</sub> x 5 <sup>1</sup> / <sub>2</sub> inch 427 x 321 x 140 mm	3 x 6 =18	DP-1613	4.8(2.19)
UFE-432	Rack Only	22 <sup>1</sup> / <sub>8</sub> x 6 <sup>5</sup> / <sub>8</sub> x 5 <sup>1</sup> / <sub>2</sub> inch 562 x 168 x 140 mm	4 x 3 =12	DP-2107	4.0(1.81)
UFE-442	Rack Only	22 <sup>1</sup> / <sub>8</sub> x 8 <sup>7</sup> / <sub>8</sub> x 5 <sup>1</sup> / <sub>2</sub> inch 562 x 225 x 140 mm	4 x 4 =16	DP-2109	4.5(2.04)
UFE-452	Rack Only	22 <sup>1</sup> / <sub>8</sub> x 11 x 5 <sup>1</sup> / <sub>2</sub> inch 562 x 280 x 140 mm	4 x 5 =20	DP-2111	5.0(2.26)
UFE-462	Rack Only	22 <sup>1</sup> / <sub>8</sub> x 12 <sup>5</sup> / <sub>8</sub> x 5 <sup>1</sup> / <sub>2</sub> inch 562 x 321 x 140 mm	4 x 6 =24	DP-2113	6.1(2.78)
UFE-472	Rack Only	22 <sup>1</sup> / <sub>8</sub> x 15 <sup>3</sup> / <sub>8</sub> x 5 <sup>1</sup> / <sub>2</sub> inch 562 x 391 x 140 mm	4 x 7 =28	DP-2115	6.8(3.10)
UFE-532	Rack Only	27 <sup>3</sup> / <sub>16</sub> x 6 <sup>5</sup> / <sub>8</sub> x 5 <sup>1</sup> / <sub>2</sub> inch 691 x 168 x 140 mm	5 x 3 =15	DP-2707	4.8(2.17)
UFE-542	Rack Only	27 <sup>3</sup> / <sub>16</sub> x 8 <sup>7</sup> / <sub>8</sub> x 5 <sup>1</sup> / <sub>2</sub> inch 691 x 225 x 140 mm	5 x 4 =20	DP-2709	5.4(2.46)
UFE-552	Rack Only	27 <sup>3</sup> / <sub>16</sub> x 11 x 5 <sup>1</sup> / <sub>2</sub> inch 691 x 280 x 140 mm	5 x 5 =25	DP-2711	5.9(2.68)

# Upright Freezer Drawer Racks

## For Standard 2" Boxes

- ◆ Racks are for standard 2" cardboard (white or yellow), plastic (polypropylene or polycarbonate) or metal (stainless or aluminum) boxes.
- ◆ Drawer Racks offer a more organized system for storage and retrieval of samples.
- ◆ Constructed of corrosion resistant stainless steel.
- ◆ Security lock devices are available for each rack.

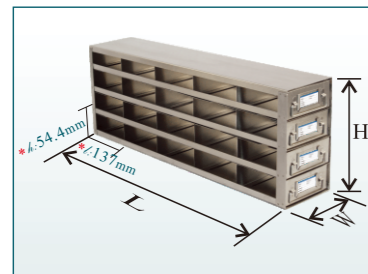

Rack Only

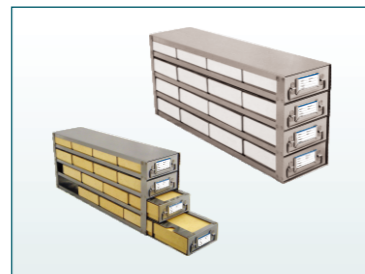

Rack w/Cardboard Box



Rack w/Metal Box



w/DD Lock Device Option

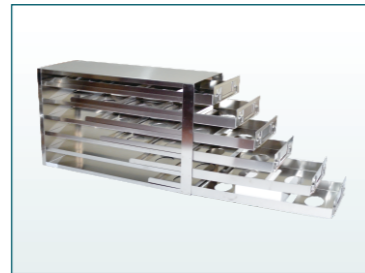

Top Loading Drawer Racks

\* UFD-262 / UFD-362 / UFD-462 / UFD-562 (∅: 51.6mm)



Yellow 2" Cardboard Box



White 2" Cardboard Box

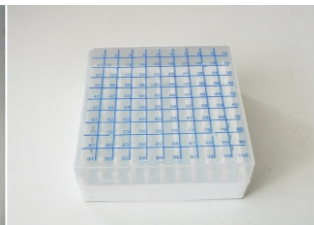

Polycarbonate Plastic Box



Metal Box  
S-Stainless Steel  
A-Aluminum

[ Check page 108 for Boxes ]

Part Number	Description	Dimension L x H x W	Capacity (Box)	Lock Device Option***	Shipping Weight lb(Kg)
UFD-222	Rack Only	11 <sup>7</sup> / <sub>16</sub> x 4 <sup>3</sup> / <sub>4</sub> x 5 <sup>1</sup> / <sub>2</sub> inch 290 x 121 x 140 mm	2 x 2 =4	DD-04	3.71(1.69)
UFD-222-W-XX**	Rack w/2" box and divider				3.71(1.69)+4*ω <sup>1</sup>
UFD-232	Rack Only	11 <sup>7</sup> / <sub>16</sub> x 7 <sup>1</sup> / <sub>8</sub> x 5 <sup>1</sup> / <sub>2</sub> inch 290 x 181 x 140 mm	2 x 3 =6	DD-06	5.26(2.39)
UFD-232-W-XX**	Rack w/2" box and divider				5.26(2.39)+6*ω <sup>1</sup>
UFD-242	Rack Only	11 <sup>7</sup> / <sub>16</sub> x 9 <sup>7</sup> / <sub>16</sub> x 5 <sup>1</sup> / <sub>2</sub> inch 290 x 240 x 140 mm	2 x 4 =8	DD-09	6.82(3.09)
UFD-242-W-XX**	Rack w/2" box and divider				6.82(3.09)+8*ω <sup>1</sup>
UFD-252	Rack Only	11 <sup>7</sup> / <sub>16</sub> x 11 <sup>13</sup> / <sub>16</sub> x 5 <sup>1</sup> / <sub>2</sub> inch 290 x 300 x 140 mm	2 x 5 =10	DD-11	8.37(3.8)
UFD-252-W-XX**	Rack w/2" box and divider				8.37(3.8)+10*ω <sup>1</sup>

# Upright Freezer Drawer Racks

## For Standard 2" Boxes

Part Number	Description	Dimension L x H x W	Capacity (Box)	Lock Device Option***	Shipping Weight lb(Kg)
UFD-262	Rack Only	11 <sup>3</sup> / <sub>8</sub> x 14 <sup>1</sup> / <sub>8</sub> x 5 <sup>1</sup> / <sub>2</sub> inch 289 x 359 x 140 mm	2 x 6 =12	DD-14	9.6(4.37)
UFD-262-S	Rack Only-Made to fit Panasonic freezer	11 <sup>7</sup> / <sub>16</sub> x 12 <sup>11</sup> / <sub>16</sub> x 5 <sup>1</sup> / <sub>2</sub> inch 290 x 322 x 140 mm			7.69(3.49)
UFD-262-W-XX**	Rack w/2" box and divider	11 <sup>3</sup> / <sub>8</sub> x 14 <sup>1</sup> / <sub>8</sub> x 5 <sup>1</sup> / <sub>2</sub> inch 289 x 359 x 140 mm			9.6(4.37)+12*ω <sup>1</sup>
UFD-332	Rack Only	16 <sup>3</sup> / <sub>4</sub> x 7 <sup>1</sup> / <sub>8</sub> x 5 <sup>1</sup> / <sub>2</sub> inch 426 x 181 x 140 mm	3 x 3 =9	DD-06	7.0(3.16)
UFD-332-W-XX**	Rack w/2" box and divider				7.0(3.16)+9*ω <sup>1</sup>
UFD-342	Rack Only	16 <sup>3</sup> / <sub>4</sub> x 9 <sup>7</sup> / <sub>16</sub> x 5 <sup>1</sup> / <sub>2</sub> inch 426 x 240 x 140 mm	3 x 4 =12	DD-09	9.0(4.1)
UFD-342-W-XX**	Rack w/2" box and divider				9.0(4.1)+12*ω <sup>1</sup>
UFD-352	Rack Only	16 <sup>3</sup> / <sub>4</sub> x 11 <sup>13</sup> / <sub>16</sub> x 5 <sup>1</sup> / <sub>2</sub> inch 426 x 300 x 140 mm	3 x 5 =15	DD-11	11.1(5.01)
UFD-352-W-XX**	Rack w/2" box and divider				11.1(5.01)+15*ω <sup>1</sup>
UFD-362	Rack Only	16 <sup>3</sup> / <sub>4</sub> x 14 <sup>1</sup> / <sub>8</sub> x 5 <sup>1</sup> / <sub>2</sub> inch 426 x 359 x 140 mm	3 x 6 =18	DD-14	13.2(5.97)
UFD-362-S	Rack Only-Made to fit Panasonic freezer				16 <sup>7</sup> / <sub>8</sub> x 12 <sup>5</sup> / <sub>8</sub> x 5 <sup>1</sup> / <sub>2</sub> inch 428 x 321 x 140 mm
UFD-362-W-XX**	Rack w/2" box and divider	16 <sup>7</sup> / <sub>8</sub> x 14 <sup>1</sup> / <sub>8</sub> x 5 <sup>1</sup> / <sub>2</sub> inch 428 x 359 x 140 mm			13.2(5.97)+18*ω <sup>1</sup>
UFD-432	Rack Only	22 <sup>5</sup> / <sub>16</sub> x 7 <sup>1</sup> / <sub>8</sub> x 5 <sup>1</sup> / <sub>2</sub> inch 566 x 181 x 140 mm	4 x 3 =12	DD-06	8.9(4.03)
UFD-432-W-XX**	Rack w/2" box and divider				8.9(4.03)+12*ω <sup>1</sup>
UFD-442	Rack Only	22 <sup>5</sup> / <sub>16</sub> x 9 <sup>7</sup> / <sub>16</sub> x 5 <sup>1</sup> / <sub>2</sub> inch 566 x 240 x 140 mm	4 x 4 =16	DD-09	11.5(5.22)
UFD-442-W-XX**	Rack w/2" box and divider				11.5(5.22)+16*ω <sup>1</sup>
UFD-452	Rack Only	22 <sup>5</sup> / <sub>16</sub> x 11 <sup>13</sup> / <sub>16</sub> x 5 <sup>1</sup> / <sub>2</sub> inch 566 x 300 x 140 mm	4 x 5 =20	DD-11	14.0(6.37)
UFD-452-S	Rack Only-Made to fit Panasonic freezer				22 <sup>5</sup> / <sub>16</sub> x 11 <sup>9</sup> / <sub>16</sub> x 5 <sup>1</sup> / <sub>2</sub> inch 566 x 293 x 140 mm
UFD-452-W-XX**	Rack w/2" box and divider	22 <sup>5</sup> / <sub>16</sub> x 11 <sup>13</sup> / <sub>16</sub> x 5 <sup>1</sup> / <sub>2</sub> inch 566 x 300 x 140 mm			14.0(6.37)+20*ω <sup>1</sup>
UFD-462	Rack Only	22 <sup>5</sup> / <sub>16</sub> x 14 <sup>1</sup> / <sub>8</sub> x 5 <sup>1</sup> / <sub>2</sub> inch 566 x 359 x 140 mm	4 x 6 =24	DD-14	16.7(7.58)
UFD-462-S	Rack Only-Made to fit Panasonic freezer				22 <sup>5</sup> / <sub>16</sub> x 12 <sup>5</sup> / <sub>8</sub> x 5 <sup>1</sup> / <sub>2</sub> inch 566 x 321 x 140 mm
UFD-462-W-XX**	Rack w/2" box and divider	22 <sup>5</sup> / <sub>16</sub> x 14 <sup>1</sup> / <sub>8</sub> x 5 <sup>1</sup> / <sub>2</sub> inch 566 x 359 x 140 mm			16.7(7.58)+24*ω <sup>1</sup>
UFD-472	Rack Only	22 <sup>5</sup> / <sub>16</sub> x 16 <sup>1</sup> / <sub>2</sub> x 5 <sup>1</sup> / <sub>2</sub> inch 566 x 419 x 140 mm	4 x 7 =28	DD-16	19.18(8.7)
UFD-472-W-XX**	Rack w/2" box and divider				19.2(8.7)+28*ω <sup>1</sup>
UFD-482	Rack Only	22 <sup>5</sup> / <sub>16</sub> x 18 <sup>7</sup> / <sub>8</sub> x 5 <sup>1</sup> / <sub>2</sub> inch 566 x 479 x 140 mm	4 x 8 =32	DD-18	22.05(10.0)
UFD-482-W-XX**	Rack w/2" box and divider				22.05(10.0)+32*ω <sup>1</sup>
UFD-532	Rack Only	27 x 7 <sup>1</sup> / <sub>8</sub> x 5 <sup>1</sup> / <sub>2</sub> inch 686 x 181 x 140 mm	5 x 3 =15	DD-06	10.6(4.8)
UFD-532-W-XX**	Rack w/2" box and divider				10.6(4.8)+15*ω <sup>1</sup>
UFD-542	Rack Only	27 x 9 <sup>7</sup> / <sub>16</sub> x 5 <sup>1</sup> / <sub>2</sub> inch 686 x 240 x 140 mm	5 x 4 =20	DD-09	13.7(6.23)
UFD-542-W-XX**	Rack w/2" box and divider				13.7(6.23)+10*ω <sup>1</sup>
UFD-552	Rack Only	27 x 11 <sup>13</sup> / <sub>16</sub> x 5 <sup>1</sup> / <sub>2</sub> inch 686 x 300 x 140 mm	5 x 5 =25	DD-11	16.9(7.65)
UFD-552-W-XX**	Rack w/2" box and divider				16.9(7.65)+25*ω <sup>1</sup>
UFD-562	Rack Only	27 <sup>1</sup> / <sub>16</sub> x 14 <sup>1</sup> / <sub>8</sub> x 5 <sup>1</sup> / <sub>2</sub> inch 687 x 359 x 140 mm	5 x 6 =30	DD-14	20.6(9.33)
UFD-562-S	Rack Only-Made to fit Panasonic freezer				27 <sup>1</sup> / <sub>16</sub> x 12 <sup>5</sup> / <sub>8</sub> x 5 <sup>1</sup> / <sub>2</sub> inch 687 x 321 x 140 mm
UFD-562-W-XX**	Rack w/2" box and divider	27 <sup>1</sup> / <sub>16</sub> x 14 <sup>1</sup> / <sub>8</sub> x 5 <sup>1</sup> / <sub>2</sub> inch 687 x 359 x 140 mm			20.6(9.33)+30*ω <sup>1</sup>

\* To order, replace XX with either 81 or 100 cell divider.  
 \*\* Lock device is ordered separately.  
 \*\*\* ω<sup>1</sup>=0.22lb(0.1kg) for cardboard box, 0.37lb(0.17kg) for plastic box, 0.84lb(0.38kg) for stainless steel box, 0.53lb(0.24kg) for aluminum box.  
 \*\*\*\* UFD-262-S, UFD-362-S, UFD-462-S, UFD-562-S, can be fitted with 2" cardboard box only, not applied to plastic box.

# Upright Sliding Tray Racks

## For Standard 2" Boxes

- ◆ For standard 2" cardboard (white or yellow), plastic (polypropylene or polycarbonate) or metal (stainless or aluminum) boxes.
- ◆ Designed for best cost Performance Function is about the same as our upright freezer drawer racks.
- ◆ Both rack frame and sliding tray are constructed of corrosion resistant stainless steel.
- ◆ Offer a more organized system for storage and retrieval of samples.

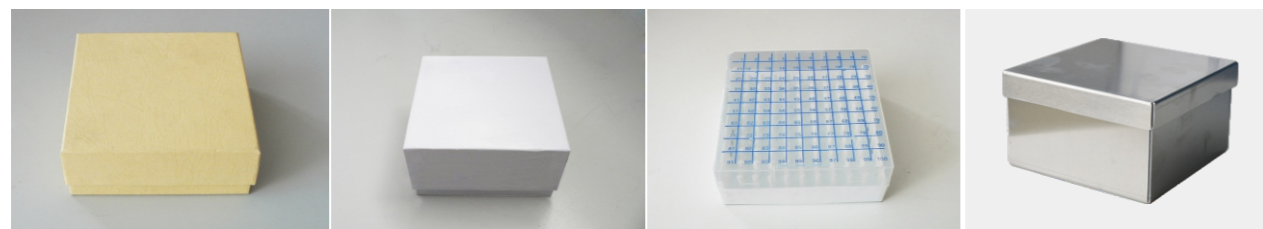
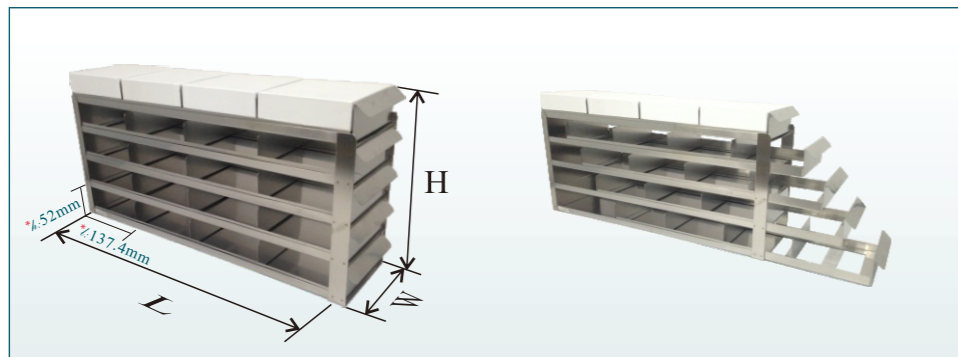

Yellow 2" Cardboard Box

White 2" Cardboard Box

Polycarbonate Plastic Box

Metal Box  
S-Stainless Steel  
A-Aluminum

[ Check page 108 for Boxes ]

# Upright Sliding Tray Racks

## For Standard 2" Boxes

Part Number	Description	Dimension L x H x W	Capacity (Box)**	Shipping Weight <sub>(b)(kg)</sub>
UFS-332	Rack Only	16 <sup>7</sup> / <sub>8</sub> x 6 <sup>5</sup> / <sub>8</sub> x 5 <sup>1</sup> / <sub>2</sub> inch 428 x 168 x 140 mm	3 x 3 =9	5.4(2.45)
UFS-342	Rack Only	16 <sup>7</sup> / <sub>8</sub> x 8 <sup>7</sup> / <sub>8</sub> x 5 <sup>1</sup> / <sub>2</sub> inch 428 x 225 x 140 mm	3 x 4 =12	7.2(3.28)
UFS-352	Rack Only	16 <sup>7</sup> / <sub>8</sub> x 11 x 5 <sup>1</sup> / <sub>2</sub> inch 428 x 280 x 140 mm	3 x 5 =15	9.1(4.11)
UFS-422	Rack Only	22 <sup>3</sup> / <sub>8</sub> x 4 <sup>9</sup> / <sub>16</sub> x 5 <sup>1</sup> / <sub>2</sub> inch 568 x 116 x 140 mm	4 x 2 =8	4.6(2.09)
UFS-432	Rack Only	22 <sup>3</sup> / <sub>8</sub> x 6 <sup>5</sup> / <sub>8</sub> x 5 <sup>1</sup> / <sub>2</sub> inch 568 x 168 x 140 mm	4 x 3 =12	6.9(3.14)
UFS-442	Rack Only	22 <sup>3</sup> / <sub>8</sub> x 8 <sup>7</sup> / <sub>8</sub> x 5 <sup>1</sup> / <sub>2</sub> inch 568 x 225 x 140 mm	4 x 4 =16	9.3(4.20)
UFS-452	Rack Only	22 <sup>3</sup> / <sub>8</sub> x 11 x 5 <sup>1</sup> / <sub>2</sub> inch 568 x 280 x 140 mm	4 x 5 =20	11.6(5.26)
UFS-462	Rack Only	22 <sup>3</sup> / <sub>8</sub> x 12 <sup>3</sup> / <sub>8</sub> x 5 <sup>1</sup> / <sub>2</sub> inch 568 x 321 x 140 mm	4 x 6 =24	12.3(5.60)
UFS-472	Rack Only	22 <sup>3</sup> / <sub>8</sub> x 15 <sup>1</sup> / <sub>2</sub> x 5 <sup>1</sup> / <sub>2</sub> inch 568 x 394 x 140 mm	4 x 7 =28	16.3(7.40)
UFS-482	Rack Only	22 <sup>3</sup> / <sub>8</sub> x 17 <sup>1</sup> / <sub>16</sub> x 5 <sup>1</sup> / <sub>2</sub> inch 568 x 450 x 140 mm	4 x 8 =32	18.5(8.40)
UFS-522	Rack Only	27 <sup>1</sup> / <sub>16</sub> x 4 <sup>9</sup> / <sub>16</sub> x 5 <sup>1</sup> / <sub>2</sub> inch 688 x 116 x 140 mm	5 x 2 =10	5.4(2.45)
UFS-532	Rack Only	27 <sup>1</sup> / <sub>16</sub> x 6 <sup>5</sup> / <sub>8</sub> x 5 <sup>1</sup> / <sub>2</sub> inch 688 x 168 x 140 mm	5 x 3 =15	8.1(3.68)
UFS-542	Rack Only	27 <sup>1</sup> / <sub>16</sub> x 8 <sup>7</sup> / <sub>8</sub> x 5 <sup>1</sup> / <sub>2</sub> inch 688 x 225 x 140 mm	5 x 4 =20	10.8(4.92)
UFS-552	Rack Only	27 <sup>1</sup> / <sub>16</sub> x 11 x 5 <sup>1</sup> / <sub>2</sub> inch 688 x 280 x 140 mm	5 x 5 =25	13.6(6.16)

## Upright Freezer Combination Drawer Racks

For 2" Boxes, 15ml & 50ml Centrifuge Tubes

- ◆ These racks conveniently store both boxes and centrifuge tubes in a single rack.
- ◆ Racks are for standard 2" cardboard (white or yellow), plastic (polypropylene or polycarbonate) or metal (stainless or aluminum) boxes and 15ml or 50ml plastic centrifuge tubes.
- ◆ Constructed of corrosion resistant stainless steel.
- ◆ Security lock devices are available for each rack.

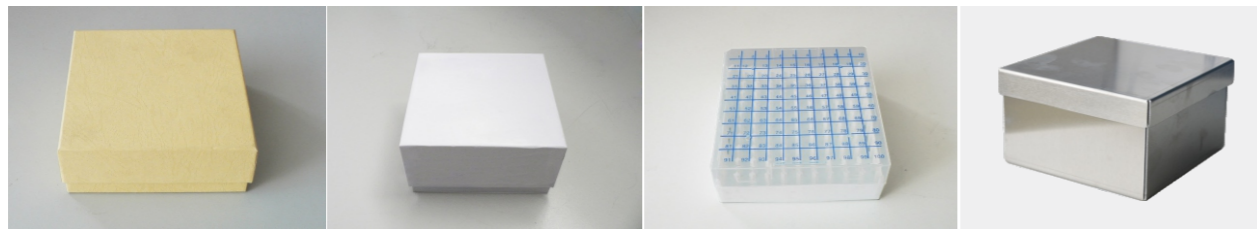
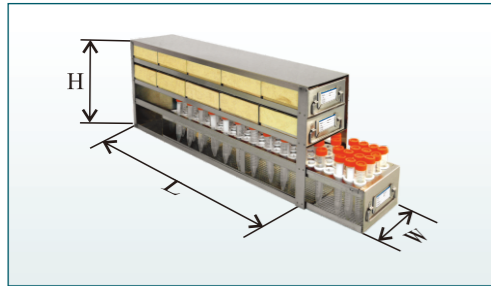

Yellow 2" Cardboard Box

White 2" Cardboard Box

Polycarbonate Plastic Box

Metal Box  
S-Stainless Steel  
A-Aluminum

[ Check page 108 for Boxes ]

## Upright Freezer Combination Drawer Racks

For 2" Boxes, 15ml & 50ml Centrifuge Tube

Part Number	Description	Dimension L x H x W	Capacity	Lock Device Option ***	Shipping Weight lb(Kg)
UFD-B-222	Rack w/2 Drawers for 4 Standard 2" Cardboard Boxes & 1 Drawer for Storage Bottles	11 <sup>5</sup> / <sub>16</sub> x 9 <sup>11</sup> / <sub>16</sub> x 5 <sup>1</sup> / <sub>2</sub> inch 287 x 246 x 140 mm	Drawer Area: 9 <sup>5</sup> / <sub>8</sub> x 4 <sup>1</sup> / <sub>2</sub> inch (per Drawer) 245 x 114 mm	DD-09	5.4 / 2.44
UFD-B-222-W-XX**	Rack w/2 Drawers Plus 4 Yellow 2" Cardboard Boxes & 1 Drawer for Storage Bottles				
UFD-B-322	Rack w/2 Drawers for 6 Standard 2" Cardboard Boxes & 1 Drawer for Storage Bottles	16 <sup>11</sup> / <sub>16</sub> x 9 <sup>11</sup> / <sub>16</sub> x 5 <sup>1</sup> / <sub>2</sub> inch 424 x 246 x 140 mm	Drawer Area: 15 <sup>1</sup> / <sub>8</sub> x 4 <sup>1</sup> / <sub>2</sub> inch (per Drawer) 382 x 114 mm	DD-09	7.6 / 3.46
UFD-B-322-W-XX**	Rack w/2 Drawers Plus 6 Yellow 2" Cardboard Boxes & 1 Drawer for Storage Bottles				
UFD-LB-422	Rack w/2 Drawers for 8 Standard 2" Cardboard Boxes & 1 Drawer for Storage Bottles	22 <sup>2</sup> / <sub>16</sub> x 9 <sup>11</sup> / <sub>16</sub> x 5 <sup>1</sup> / <sub>2</sub> inch 564 x 246 x 140 mm	Drawer Area: 20 <sup>7</sup> / <sub>8</sub> x 4 <sup>1</sup> / <sub>2</sub> inch (per Drawer) 523 x 114 mm	DD-09	9.5 / 4.32
UFD-LB-422-W-XX**	Rack w/2 Drawers Plus 8 Yellow 2" Cardboard Boxes & 1 Drawer for Storage Bottles				
UFD-XLB-522	Rack w/2 Drawers for 10 Standard 2" Cardboard Boxes & 1 Drawer for Storage Bottles	26 <sup>15</sup> / <sub>16</sub> x 9 <sup>11</sup> / <sub>16</sub> x 5 <sup>1</sup> / <sub>2</sub> inch 685 x 246 x 140 mm	Drawer Area: 25 <sup>5</sup> / <sub>8</sub> x 4 <sup>1</sup> / <sub>2</sub> inch (per Drawer) 644 x 114 mm	DD-09	11.3 / 5.13
UFD-XLB-522-W-XX**	Rack w/2 Drawers Plus 10 Yellow 2" Cardboard Boxes & 1 Drawer for Storage Bottles				
UFD-T15-222	Rack w/2 Drawers for 4 Standard 2" Cardboard Boxes & 1 Drawer for 15ml Centrifuge Tubes	11 <sup>5</sup> / <sub>16</sub> x 9 <sup>11</sup> / <sub>16</sub> x 5 <sup>1</sup> / <sub>2</sub> inch 287 x 246 x 140 mm	4 Boxes Plus 36 Tubes(15ml)	DD-09	5.8 / 2.64
UFD-T15-222-W-XX**	Rack w/2 Drawers Plus 4 Yellow 2" Cardboard Boxes & 1 Drawer for 15ml Centrifuge Tubes				
UFD-T15-322	Rack w/2 Drawers for 6 Standard 2" Cardboard Boxes & 1 Drawer for 15ml Centrifuge Tubes	16 <sup>11</sup> / <sub>16</sub> x 9 <sup>11</sup> / <sub>16</sub> x 5 <sup>1</sup> / <sub>2</sub> inch 424 x 246 x 140 mm	6 Boxes Plus 60 Tubes(15ml)	DD-09	8.3 / 3.75
UFD-T15-322-W-XX**	Rack w/2 Drawers Plus 6 Yellow 2" Cardboard Boxes & 1 Drawer for 15ml Centrifuge Tubes				
UFD-LT15-422	Rack w/2 Drawers for 8 Standard 2" Cardboard Boxes & 1 Drawer for 15ml Centrifuge Tubes	22 <sup>2</sup> / <sub>16</sub> x 9 <sup>11</sup> / <sub>16</sub> x 5 <sup>1</sup> / <sub>2</sub> inch 564 x 246 x 140 mm	8 Boxes Plus 80 Tubes(15ml)	DD-09	10.4 / 4.72
UFD-LT15-422-W-XX**	Rack w/2 Drawers Plus 8 Yellow 2" Cardboard Boxes & 1 Drawer for 15ml Centrifuge Tubes				
UFD-XLT15-522	Rack w/2 Drawers for 10 Standard 2" Cardboard Boxes & 1 Drawer for 15ml Centrifuge Tubes	26 <sup>15</sup> / <sub>16</sub> x 9 <sup>11</sup> / <sub>16</sub> x 5 <sup>1</sup> / <sub>2</sub> inch 685 x 246 x 140 mm	10 Boxes Plus 100 Tubes(15ml)	DD-09	12.4 / 5.61
UFD-XLT15-522-W-XX**	Rack w/2 Drawers Plus 10 Yellow 2" Cardboard Boxes & 1 Drawer for 15ml Centrifuge Tubes				
UFD-T50-222	Rack w/2 Drawers for 4 Standard 2" Cardboard Boxes & 1 Drawer for 50ml Centrifuge Tubes	11 <sup>5</sup> / <sub>16</sub> x 9 <sup>11</sup> / <sub>16</sub> x 5 <sup>1</sup> / <sub>2</sub> inch 287 x 246 x 140 mm	4 Boxes Plus 18 Tubes(50ml)	DD-09	5.8 / 2.61
UFD-T50-222-W-XX**	Rack w/2 Drawers Plus 4 Yellow 2" Cardboard Boxes & 1 Drawer for 50ml Centrifuge Tubes				
UFD-T50-322	Rack w/2 Drawers for 6 Standard 2" Cardboard Boxes & 1 Drawer for 50ml Centrifuge Tubes	16 <sup>11</sup> / <sub>16</sub> x 9 <sup>11</sup> / <sub>16</sub> x 5 <sup>1</sup> / <sub>2</sub> inch 424 x 246 x 140 mm	6 Boxes Plus 30 Tubes(50ml)	DD-09	8.2 / 3.70
UFD-T50-322-W-XX**	Rack w/2 Drawers Plus 6 Yellow 2" Cardboard Boxes & 1 Drawer for 50ml Centrifuge Tubes				
UFD-LT50-422	Rack w/2 Drawers for 8 Standard 2" Cardboard Boxes & 1 Drawer for 50ml Centrifuge Tubes	22 <sup>2</sup> / <sub>16</sub> x 9 <sup>11</sup> / <sub>16</sub> x 5 <sup>1</sup> / <sub>2</sub> inch 564 x 246 x 140 mm	8 Boxes Plus 39 Tubes(50ml)	DD-09	10.3 / 4.67
UFD-LT50-422-W-XX**	Rack w/2 Drawers Plus 8 Yellow 2" Cardboard Boxes & 1 Drawer for 50ml Centrifuge Tubes				
UFD-XLT50-522	Rack w/2 Drawers for 10 Standard 2" Cardboard Boxes & 1 Drawer for 50ml Centrifuge Tubes	26 <sup>15</sup> / <sub>16</sub> x 9 <sup>11</sup> / <sub>16</sub> x 5 <sup>1</sup> / <sub>2</sub> inch 684 x 246 x 140 mm	10 Boxes Plus 51 Tubes(50ml)	DD-09	12.2 / 5.53
UFD-XLT50-522-W-XX**	Rack w/2 Drawers Plus 10 Yellow 2" Cardboard Boxes & 1 Drawer for 50ml Centrifuge Tubes				

\* To order, replace XX with either 81 or 100 cell divider.

\*\* Lock device is ordered separately.



# Vertical Racks for Chest Freezer & Liquid Nitrogen Tanks

(Locking Rod Included)

## For Standard 2" Boxes

- ◆ Racks are for standard 2" cardboard (white or yellow), plastic (Polypropylene or polycarbonate) or metal (stainless or aluminum) boxes.
- ◆ Constructed of corrosion resistant stainless steel.
- ◆ Security lock devices are available for each rack.

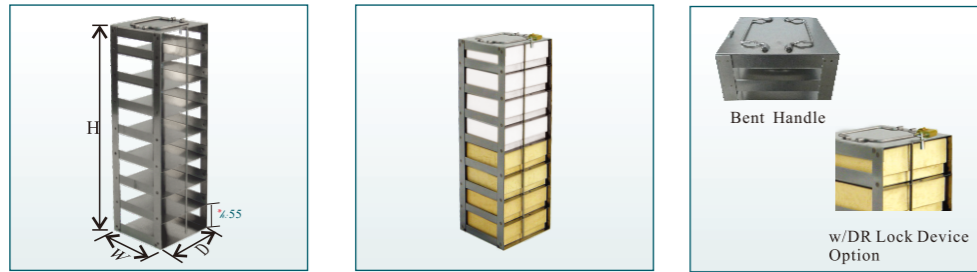

Rack Only

Rack w/Cardboard Box

Bent Handle

w/DR Lock Device Option



Yellow 2" Cardboard Box

White 2" Cardboard Box

Polycarbonate Plastic Box

Metal Box S-Stainless Steel A-Aluminum

[ Check page 108 for Boxes ]

Part Number	Description	Dimension H x W x D	Capacity (Box)	Lock Device Option***	Shipping Weight lb(Kg)
CF-3-2	Rack Only	16 <sup>7</sup> / <sub>8</sub> x 5 <sup>5</sup> / <sub>8</sub> x 5 <sup>1</sup> / <sub>2</sub> inch 175 x 143 x 140 mm	3	DR-06	1.4(0.64)
CF-4-2	Rack Only	9 <sup>1</sup> / <sub>8</sub> x 5 <sup>5</sup> / <sub>8</sub> x 5 <sup>1</sup> / <sub>2</sub> inch 231 x 143 x 140 mm	4	DR-09	1.9(0.85)
CF-5-2	Rack Only	11 <sup>5</sup> / <sub>16</sub> x 5 <sup>5</sup> / <sub>8</sub> x 5 <sup>1</sup> / <sub>2</sub> inch 287 x 143 x 140 mm	5	DR-11	2.2(1.01)
CF-6-2	Rack Only	13 <sup>1</sup> / <sub>2</sub> x 5 <sup>5</sup> / <sub>8</sub> x 5 <sup>1</sup> / <sub>2</sub> inch 343 x 143 x 140 mm	6	DR-12	2.6(1.16)
CF-7-2	Rack Only	15 <sup>11</sup> / <sub>16</sub> x 5 <sup>5</sup> / <sub>8</sub> x 5 <sup>1</sup> / <sub>2</sub> inch 399 x 143 x 140 mm	7	DR-15	2.9(1.30)
CF-8-2	Rack Only	17 <sup>7</sup> / <sub>8</sub> x 5 <sup>5</sup> / <sub>8</sub> x 5 <sup>1</sup> / <sub>2</sub> inch 454 x 143 x 140 mm	8	DR-17	3.2(1.46)
CF-9-2	Rack Only	20 <sup>1</sup> / <sub>16</sub> x 5 <sup>5</sup> / <sub>8</sub> x 5 <sup>1</sup> / <sub>2</sub> inch 510 x 143 x 140 mm	9	DR-19	3.5(1.60)
CF-10-2	Rack Only	22 <sup>3</sup> / <sub>16</sub> x 5 <sup>5</sup> / <sub>8</sub> x 5 <sup>1</sup> / <sub>2</sub> inch 566 x 143 x 140 mm	10	DR-22	3.9(1.76)
CF-10-2-W-XX**	Rack w/2" box and divider				3.9(1.76)+10*ω <sup>†</sup>
CF-11-2	Rack Only	24 <sup>1</sup> / <sub>2</sub> x 5 <sup>5</sup> / <sub>8</sub> x 5 <sup>1</sup> / <sub>2</sub> inch 622 x 143 x 140 mm	11	DR-23	4.2(1.91)
CF-11-2-W-XX**	Rack w/2" box and divider				4.2(1.91)+11*ω <sup>†</sup>
CF-12-2	Rack Only	26 <sup>7</sup> / <sub>8</sub> x 5 <sup>5</sup> / <sub>8</sub> x 5 <sup>1</sup> / <sub>2</sub> inch 677 x 143 x 140 mm	12	DR-26	4.6(2.07)
CF-12-2-W-XX**	Rack w/2" box and divider				4.6(2.07)+12*ω <sup>†</sup>
CF-13-2	Rack Only	28 <sup>1</sup> / <sub>2</sub> x 5 <sup>5</sup> / <sub>8</sub> x 5 <sup>1</sup> / <sub>2</sub> inch 724 x 143 x 140 mm	13	DR-27	4.9(2.21)
CF-13-2-W-XX**	Rack w/2" box and divider				4.9(2.21)+13*ω <sup>†</sup>
CF-14-2	Rack Only	31 <sup>1</sup> / <sub>16</sub> x 5 <sup>5</sup> / <sub>8</sub> x 5 <sup>1</sup> / <sub>2</sub> inch 789 x 143 x 140 mm	14	DR-31	5.2(2.37)
CF-14-2-W-XX**	Rack w/2" box and divider				5.2(2.37)+14*ω <sup>†</sup>
CF-15-2	Rack Only	33 <sup>1</sup> / <sub>4</sub> x 5 <sup>5</sup> / <sub>8</sub> x 5 <sup>1</sup> / <sub>2</sub> inch 845 x 143 x 140 mm	15	DR-32	5.6(2.52)
CF-15-2-W-XX**	Rack w/2" box and divider				5.6(2.52)+15*ω <sup>†</sup>

\* To order, replace XX with either 81 or 100 cell divider.

\*\* Lock device is ordered separately.

\*\*\* ω<sup>†</sup>=0.221lb(0.1kg) for cardboard box, 0.371lb(0.17kg) for plastic box, 0.841lb(0.38kg) for stainless steel box, 0.531lb(0.24kg) for aluminum box.

# Spring Clip Vertical Racks for Chest Freezer & Liquid Nitrogen Tanks

(Locking Rod Included)

## For Standard 2" Boxes

- ◆ Racks are for standard 2" cardboard (white or yellow), plastic (Polypropylene or polycarbonate) or metal (stainless or aluminum) boxes.
- ◆ Made of corrosion resistant stainless steel.
- ◆ Spring clips securely hold boxes in rack compartments without using locking rods and allow for easy removal of boxes.
- ◆ Security lock devices are available for each rack.

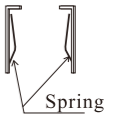
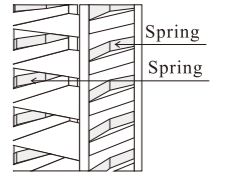

Rack Only

Rack w/Cardboard Box

Rack w/Polycarbonate Plastic Box

Rack w/Metal Box

w/DR Lock Device Option



Yellow 2" Cardboard Box

White 2" Cardboard Box

Polycarbonate Plastic Box

Metal Box S-Stainless Steel A-Aluminum

[ Check page 108 for Boxes ]

Part Number	Description	Dimension H x W x D	Capacity (Box)	Lock Device Option***	Shipping Weight lb(Kg)
CF-9-2-S	Rack Only	20 <sup>1</sup> / <sub>16</sub> x 5 <sup>5</sup> / <sub>8</sub> x 5 <sup>1</sup> / <sub>2</sub> inch 510 x 143 x 140 mm	9	DR-19	4.1(1.84)
CF-9-2-S-W-XX**	Rack w/2" box and divider				4.1(1.84)+9*ω <sup>†</sup>
CF-10-2-S	Rack Only	22 <sup>3</sup> / <sub>16</sub> x 5 <sup>5</sup> / <sub>8</sub> x 5 <sup>1</sup> / <sub>2</sub> inch 566 x 143 x 140 mm	10	DR-22	4.4(2.01)
CF-10-2-S-W-XX**	Rack w/2" box and divider				4.4(2.01)+10*ω <sup>†</sup>
CF-11-2-S	Rack Only	24 <sup>1</sup> / <sub>2</sub> x 5 <sup>5</sup> / <sub>8</sub> x 5 <sup>1</sup> / <sub>2</sub> inch 622 x 143 x 140 mm	11	DR-23	4.8(2.18)
CF-11-2-S-W-XX**	Rack w/2" box and divider				4.8(2.18)+11*ω <sup>†</sup>
CF-12-2-S	Rack Only	26 <sup>7</sup> / <sub>8</sub> x 5 <sup>5</sup> / <sub>8</sub> x 5 <sup>1</sup> / <sub>2</sub> inch 677 x 143 x 140 mm	12	DR-26	5.2(2.37)
CF-12-2-S-W-XX**	Rack w/2" box and divider				5.2(2.37)+12*ω <sup>†</sup>
CF-13-2-S	Rack Only	28 <sup>1</sup> / <sub>2</sub> x 5 <sup>5</sup> / <sub>8</sub> x 5 <sup>1</sup> / <sub>2</sub> inch 724 x 143 x 140 mm	13	DR-27	5.6(2.53)
CF-13-2-S-W-XX**	Rack w/2" box and divider				5.6(2.53)+13*ω <sup>†</sup>
CF-14-2-S	Rack Only	31 <sup>1</sup> / <sub>16</sub> x 5 <sup>5</sup> / <sub>8</sub> x 5 <sup>1</sup> / <sub>2</sub> inch 789 x 143 x 140 mm	14	DR-31	6.0(2.72)
CF-14-2-S-W-XX**	Rack w/2" box and divider				6.0(2.72)+14*ω <sup>†</sup>
CF-15-2-S	Rack Only	33 <sup>1</sup> / <sub>4</sub> x 5 <sup>5</sup> / <sub>8</sub> x 5 <sup>1</sup> / <sub>2</sub> inch 845 x 143 x 140 mm	15	DR-32	6.4(2.90)
CF-15-2-S-W-XX**	Rack w/2" box and divider				6.4(2.90)+15*ω <sup>†</sup>

\* To order, replace XX with either 81 or 100 cell divider.

\*\* Lock device is ordered separately.

\*\*\* ω<sup>†</sup>=0.221lb(0.1kg) for cardboard box, 0.371lb(0.17kg) for plastic box, 0.841lb(0.38kg) for stainless steel box, 0.531lb(0.24kg) for aluminum box.

# Vertical Half Racks

(Locking Rod Included)

## For Standard 2" Boxes

- ◆ Racks are for standard 2" cardboard (white or yellow), plastic (polypropylene or polycarbonate) or metal (stainless or aluminum) boxes.
- ◆ Made of corrosion resistant stainless steel.
- ◆ Racks are ideal for light load and easy handling of sample storage in freezers or liquid nitrogen tanks.
- ◆ Locking rod is included for each rack.

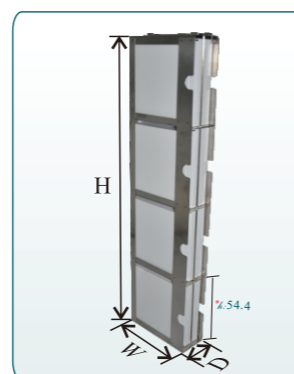

Rack w/Cardboard Boxes

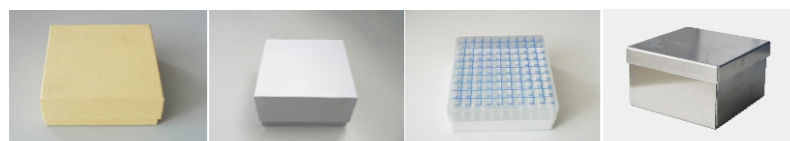

Yellow 2" Cardboard Box    White 2" Cardboard Box    Polycarbonate Plastic Box    Metal Box  
S-Stainless Steel    A-Aluminum

[ Check page 108 for Boxes ]

Part Number	Description	Dimension H x D x W	Capacity (Box)	Shipping Weight lb(Kg)
LR-3-2	Rack Only	16 1/2 x 2 1/4 x 5 9/16 inch 419 x 57 x 141 mm	3	1.2(0.56)
LR-3-2-W-XX**	Rack w/2" box and divider			1.2(0.56)+3*ω <sup>1</sup>
LR-4-2	Rack Only	21 15/16 x 2 1/4 x 5 9/16 inch 557 x 57 x 141 mm	4	1.6(0.71)
LR-4-2-W-XX**	Rack w/2" box and divider			1.6(0.71)+4*ω <sup>1</sup>
LR-5-2	Rack Only	26 3/4 x 2 1/4 x 5 9/16 inch 679 x 57 x 141 mm	5	1.9(0.86)
LR-5-2-W-XX**	Rack w/2" box and divider			1.9(0.86)+5*ω <sup>1</sup>
LR-6-2	Rack Only	32 13/16 x 2 1/4 x 5 9/16 inch 817 x 57 x 141 mm	6	2.2(1.02)
LR-6-2-W-XX**	Rack w/2" box and divider			2.2(1.02)+6*ω <sup>1</sup>

\* To order, replace XX with either 81 or 100 cell divider.

\*\* Lock device is ordered separately.

\*\*\* ω<sup>1</sup>=0.221b(0.1kg) for cardboard box, 0.371b(0.17kg) for plastic box, 0.841b(0.38kg) for stainless steel box, 0.531b(0.24kg) for aluminum box.

# Vertical Aluminum Racks for Chest Freezer & Liquid Nitrogen Tanks

(Locking Rod Included)

## For Standard 2" Boxes

- ◆ Racks are for standard 2" cardboard (white or yellow), plastic (polypropylene or polycarbonate) or metal (stainless or aluminum) boxes.
- ◆ Made of aluminum, these racks offer better temperature uniformity in vapor phase in liquid nitrogen tank and are ideal for long term storage of samples that are accessed infrequently.
- ◆ Security lock devices are available for each rack.

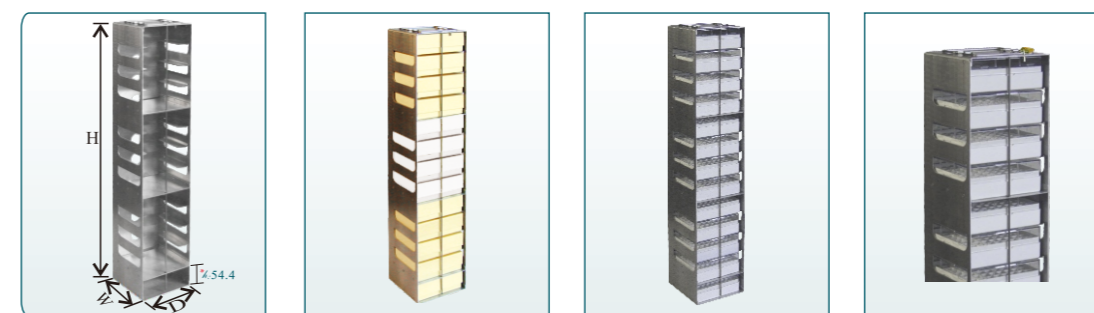

Rack Only    Rack w/Cardboard Box    Rack w/Polycarbonate Plastic Box    Rack w/DR Device Option

Part Number	Description	Dimension H x W x D	Capacity (Box)	Lock Device Option***	Shipping Weight lb(Kg)
CFA-3-2	Rack Only	6 7/8 x 5 5/8 x 5 1/2 inch 175 x 143 x 140 mm	3	DR-06	1.0(0.45)
CFA-4-2	Rack Only	9 1/8 x 5 5/8 x 5 1/2 inch 231 x 143 x 140 mm	4	DR-09	1.1(0.52)
CFA-5-2	Rack Only	11 5/16 x 5 5/8 x 5 1/2 inch 287 x 143 x 140 mm	5	DR-11	1.3(0.59)
CFA-6-2	Rack Only	13 7/16 x 5 5/8 x 5 1/2 inch 342 x 143 x 140 mm	6	DR-13	1.6(0.74)
CFA-7-2	Rack Only	15 11/16 x 5 5/8 x 5 1/2 inch 398 x 143 x 140 mm	7	DR-15	1.8(0.82)
CFA-8-2	Rack Only	17 7/8 x 5 5/8 x 5 1/2 inch 454 x 143 x 140 mm	8	DR-17	2.1(0.94)
CFA-9-2	Rack Only	20 1/16 x 5 5/8 x 5 1/2 inch 510 x 143 x 140 mm	9	DR-20	2.4(1.11)
CFA-10-2	Rack Only	22 5/16 x 5 5/8 x 5 1/2 inch 566 x 143 x 140 mm	10	DR-22	2.7(1.23)
CFA-10-2-X'-XX**	Rack w/2" box and divider				2.7(1.23)+10*ω <sup>1</sup>
CFA-11-2	Rack Only	24 1/2 x 5 5/8 x 5 1/2 inch 622 x 143 x 140 mm	11	DR-23	2.9(1.30)
CFA-11-2-X'-XX**	Rack w/2" box and divider				2.9(1.30)+11*ω <sup>1</sup>
CFA-12-2	Rack Only	26 3/8 x 5 5/8 x 5 1/2 inch 677 x 143 x 140 mm	12	DR-26	3.0(1.37)
CFA-12-2-X'-XX**	Rack w/2" box and divider				3.0(1.37)+12*ω <sup>1</sup>
CFA-13-2	Rack Only	28 9/16 x 5 5/8 x 5 1/2 inch 726 x 143 x 140 mm	13	DR-27	3.4(1.55)
CFA-13-2-X'-XX**	Rack w/2" box and divider				3.4(1.55)+13*ω <sup>1</sup>
CFA-14-2	Rack Only	31 1/16 x 5 5/8 x 5 1/2 inch 789 x 143 x 140 mm	14	DR-31	3.5(1.61)
CFA-14-2-X'-XX**	Rack w/2" box and divider				3.5(1.61)+14*ω <sup>1</sup>
CFA-15-2	Rack Only	33 1/4 x 5 5/8 x 5 1/2 inch 845 x 143 x 140 mm	15	DR-32	3.7(1.69)
CFA-15-2-X'-XX**	Rack w/2" box and divider				3.7(1.69)+15*ω <sup>1</sup>

\* To order, replace XX with either 81 or 100 cell divider.

\*\* Lock device is ordered separately.

\*\*\* ω<sup>1</sup>=0.221b(0.1kg) for cardboard box, 0.371b(0.17kg) for plastic box, 0.841b(0.38kg) for stainless steel box, 0.531b(0.24kg) for aluminum box.

# Vertical Mini Racks for Chest Freezer & Liquid Nitrogen Tanks

(Locking Rod Included)

## For 2" Mini Boxes

- ◆ Racks are for mini 2" cardboard or polycarbonate boxes.
- ◆ Made of corrosion resistant stainless steel.
- ◆ Security lock devices are available for each rack.

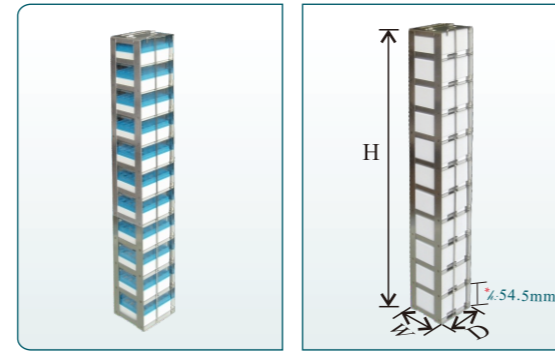

Rack w/Polycarbonate Plastic Box

Rack w/Cardboard Box

Part Number	Description	Dimension H x W x D	Capacity (Box)	Lock Device Option**	Shipping Weight lb(Kg)
MCF-3-2	Rack Only	6 <sup>7</sup> / <sub>8</sub> x 3 <sup>3</sup> / <sub>8</sub> x 3 <sup>1</sup> / <sub>4</sub> inch 175 x 86 x 82 mm	3	DR-06	0.7(0.32)
MCF-4-2	Rack Only	9 <sup>1</sup> / <sub>8</sub> x 3 <sup>3</sup> / <sub>8</sub> x 3 <sup>1</sup> / <sub>4</sub> inch 231 x 86 x 82 mm	4	DR-09	0.9(0.42)
MCF-5-2	Rack Only	11 <sup>1</sup> / <sub>4</sub> x 3 <sup>3</sup> / <sub>8</sub> x 3 <sup>1</sup> / <sub>4</sub> inch 286 x 86 x 82 mm	5	DR-11	1.1(0.49)
MCF-6-2	Rack Only	13 <sup>7</sup> / <sub>16</sub> x 3 <sup>3</sup> / <sub>8</sub> x 3 <sup>1</sup> / <sub>4</sub> inch 342 x 86 x 82 mm	6	DR-13	1.3(0.58)
MCF-7-2	Rack Only	15 <sup>11</sup> / <sub>16</sub> x 3 <sup>3</sup> / <sub>8</sub> x 3 <sup>1</sup> / <sub>4</sub> inch 398 x 86 x 82 mm	7	DR-15	1.5(0.66)
MCF-8-2	Rack Only	17 <sup>7</sup> / <sub>8</sub> x 3 <sup>3</sup> / <sub>8</sub> x 3 <sup>1</sup> / <sub>4</sub> inch 454 x 86 x 82 mm	8	DR-17	1.7(0.76)
MCF-9-2	Rack Only	20 <sup>1</sup> / <sub>16</sub> x 3 <sup>3</sup> / <sub>8</sub> x 3 <sup>1</sup> / <sub>4</sub> inch 510 x 86 x 82 mm	9	DR-19	1.9(0.84)
MCF-10-2	Rack Only	22 <sup>5</sup> / <sub>16</sub> x 3 <sup>3</sup> / <sub>8</sub> x 3 <sup>1</sup> / <sub>4</sub> inch 566 x 86 x 82 mm	10	DR-22	2.0(0.92)
MCF-10-2-X'	Rack w/ 2" box and divider				2.0(0.92)+10*ω <sup>1</sup>
MCF-11-2	Rack Only	24 <sup>1</sup> / <sub>2</sub> x 3 <sup>3</sup> / <sub>8</sub> x 3 <sup>1</sup> / <sub>4</sub> inch 622 x 86 x 82 mm	11	DR-23	2.2(1.00)
MCF-11-2-X'	Rack w/ 2" box and divider				2.2(1.00)+11*ω <sup>1</sup>
MCF-12-2	Rack Only	26 <sup>5</sup> / <sub>8</sub> x 3 <sup>3</sup> / <sub>8</sub> x 3 <sup>1</sup> / <sub>4</sub> inch 677 x 86 x 82 mm	12	DR-26	2.4(1.08)
MCF-12-2-X'	Rack w/ 2" box and divider				2.4(1.08)+12*ω <sup>1</sup>
MCF-13-2	Rack Only	28 <sup>1</sup> / <sub>2</sub> x 3 <sup>3</sup> / <sub>8</sub> x 3 <sup>1</sup> / <sub>4</sub> inch 724 x 86 x 82 mm	13	DR-27	2.6(1.16)
MCF-13-2-X'	Rack w/ 2" box and divider				2.6(1.16)+13*ω <sup>1</sup>
MCF-14-2	Rack Only	31 <sup>1</sup> / <sub>16</sub> x 3 <sup>3</sup> / <sub>8</sub> x 3 <sup>1</sup> / <sub>4</sub> inch 789 x 86 x 82 mm	14	DR-31	2.7(1.24)
MCF-14-2-X'	Rack w/ 2" box and divider				2.7(2.24)+14*ω <sup>1</sup>
MCF-15-2	Rack Only	33 <sup>1</sup> / <sub>4</sub> x 3 <sup>3</sup> / <sub>8</sub> x 3 <sup>1</sup> / <sub>4</sub> inch 845 x 86 x 82 mm	15	DR-32	2.9(1.33)
MCF-15-2-X'	Rack w/ 2" box and divider				2.9(1.33)+15*ω <sup>1</sup>

\* To order replace X with B-Cardboard Mini Box with 25 cell divider or P- Mini Polycarbonate Box with 25 cell divider.

\*\* Lock device is ordered separately.

\*\*\* ω<sup>1</sup>=0.091lb(0.04kg) for cardboard box, 0.371lb(0.17kg) for plastic box.

# Mini Spring Clip Vertical Racks for Chest Freezer & Liquid Nitrogen Tanks

(Locking Rod Included)

## For 2" Mini Boxes

- ◆ Racks are for mini 2" cardboard or polycarbonate boxes.
- ◆ Made of corrosion resistant stainless steel.
- ◆ Spring clips securely hold boxes in rack compartments without using locking rods and allow for easy removal of boxes.
- ◆ Security lock devices are available for each rack.

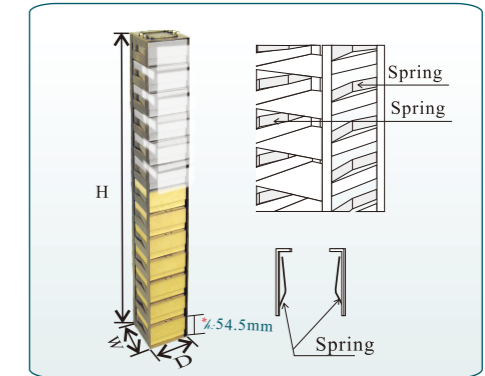

Part Number	Description	Dimension H x W x D	Capacity (Box)	Lock Device Option**	Shipping Weight lb(Kg)
MCF-9-2-S	Rack Only	20 <sup>1</sup> / <sub>16</sub> x 3 <sup>3</sup> / <sub>8</sub> x 3 <sup>1</sup> / <sub>4</sub> inch 509 x 86 x 82mm	9	DR-19	2.1(0.94)
MCF-10-2-S	Rack Only	22 <sup>5</sup> / <sub>16</sub> x 3 <sup>3</sup> / <sub>8</sub> x 3 <sup>1</sup> / <sub>4</sub> inch 565 x 86 x 82mm	10	DR-22	2.3(1.04)
MCF-10-2-S-X'	Rack w/2" box and divider				2.3(1.04)+10*ω <sup>1</sup>
MCF-11-2-S	Rack Only	24 <sup>7</sup> / <sub>16</sub> x 3 <sup>3</sup> / <sub>8</sub> x 3 <sup>1</sup> / <sub>4</sub> inch 621 x 86 x 82mm	11	DR-23	2.5(1.14)
MCF-11-2-S-X'	Rack w/2" box and divider				2.5(1.14)+11*ω <sup>1</sup>
MCF-12-2-S	Rack Only	26 <sup>5</sup> / <sub>8</sub> x 3 <sup>3</sup> / <sub>8</sub> x 3 <sup>1</sup> / <sub>4</sub> inch 676 x 86 x 82mm	12	DR-26	2.7(1.24)
MCF-12-2-S-X'	Rack w/2" box and divider				2.7(1.24)+12*ω <sup>1</sup>
MCF-13-2-S	Rack Only	28 <sup>7</sup> / <sub>16</sub> x 3 <sup>3</sup> / <sub>8</sub> x 3 <sup>1</sup> / <sub>4</sub> inch 723 x 86 x 82mm	13	DR-27	2.9(1.33)
MCF-13-2-S-X'	Rack w/2" box and divider				2.9(1.33)+13*ω <sup>1</sup>
MCF-14-2-S	Rack Only	31 x 3 <sup>3</sup> / <sub>8</sub> x 3 <sup>1</sup> / <sub>4</sub> inch 788 x 86 x 82mm	14	DR-31	3.1(1.42)
MCF-14-2-S-X'	Rack w/2" box and divider				3.1(1.42)+14*ω <sup>1</sup>
MCF-15-2-S	Rack Only	33 <sup>1</sup> / <sub>4</sub> x 3 <sup>3</sup> / <sub>8</sub> x 3 <sup>1</sup> / <sub>4</sub> inch 844 x 86 x 82mm	15	DR-32	3.4(1.52)
MCF-15-2-S-X'	Rack w/2" box and divider				3.4(1.52)+15*ω <sup>1</sup>

\* To order replace X with B-Cardboard Mini Box with 25 cell divider or P- Mini Polycarbonate Box with 25 cell divider.

\*\* Lock device is ordered separately.

\*\*\* ω<sup>1</sup>=0.091lb(0.04kg) for cardboard box, 0.371lb(0.17kg) for plastic box.

# Vertical Aluminum Mini Racks for Chest Freezer & Liquid Nitrogen Tanks

(Locking Rod Included)

## For 2" Mini Boxes

- ◆ Racks are for mini 2" cardboard, polycarbonate boxes.
- ◆ Made of aluminum, these racks offer better temperature uniformity in vapor phase in liquid nitrogen tanks and are ideal for long term storage of samples that are accessed infrequently.
- ◆ Security lock devices are available for each rack.

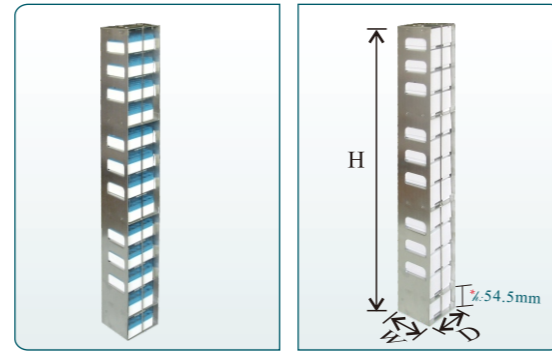

Rack w/Polycarbonate Plastic Box

Rack w/Cardboard Box

Part Number	Description	Dimension H x W x D	Capacity (Box)	Lock Device Option**	Shipping Weight (lb/Kg)
MCFA-9-2	Rack Only	20 <sup>1</sup> / <sub>16</sub> x 3 <sup>3</sup> / <sub>8</sub> x 3 <sup>1</sup> / <sub>4</sub> inch 509 x 86 x 82 mm	9	DR-19	1.3(0.61)
MCFA-10-2	Rack Only	22 <sup>1</sup> / <sub>4</sub> x 3 <sup>3</sup> / <sub>8</sub> x 3 <sup>1</sup> / <sub>4</sub> inch 565 x 86 x 82 mm	10	DR-22	1.5(0.66)
MCFA-10-2-X*	Rack w/ 2" box and divider				1.5(0.66)+10*ω <sup>1</sup>
MCFA-11-2	Rack Only	24 <sup>7</sup> / <sub>16</sub> x 3 <sup>3</sup> / <sub>8</sub> x 3 <sup>1</sup> / <sub>4</sub> inch 621 x 86 x 82 mm	11	DR-23	1.6(0.73)
MCFA-11-2-X*	Rack w/ 2" box and divider				1.6(0.73)+11*ω <sup>1</sup>
MCFA-12-2	Rack Only	26 <sup>5</sup> / <sub>8</sub> x 3 <sup>3</sup> / <sub>8</sub> x 3 <sup>1</sup> / <sub>4</sub> inch 676 x 86 x 82 mm	12	DR-26	1.7(0.76)
MCFA-12-2-X*	Rack w/ 2" box and divider				1.7(0.76)+12*ω <sup>1</sup>
MCFA-13-2	Rack Only	28 <sup>7</sup> / <sub>16</sub> x 3 <sup>3</sup> / <sub>8</sub> x 3 <sup>1</sup> / <sub>4</sub> inch 723 x 86 x 82 mm	13	DR-27	1.9(0.87)
MCFA-13-2-X*	Rack w/ 2" box and divider				1.9(0.87)+13*ω <sup>1</sup>
MCFA-14-2	Rack Only	31 x 3 <sup>3</sup> / <sub>8</sub> x 3 <sup>1</sup> / <sub>4</sub> inch 788 x 86 x 82 mm	14	DR-31	2.0(0.92)
MCFA-14-2-X*	Rack w/ 2" box and divider				2.0(0.92)+14*ω <sup>1</sup>
MCFA-15-2	Rack Only	33 <sup>1</sup> / <sub>4</sub> x 3 <sup>3</sup> / <sub>8</sub> x 3 <sup>1</sup> / <sub>4</sub> inch 844 x 86 x 82 mm	15	DR-32	2.2(1.02)
MCFA-15-2-X*	Rack w/ 2" box and divider				2.2(1.02)+15*ω <sup>1</sup>

\* To order replace X with B-Cardboard Mini Box with 25 cell divider or P-Plastic Mini Polycarbonate Box with 25 cell divider.

\*\* Lock device is ordered separately.

\*\*\* ω<sup>1</sup>=0.09lb(0.04kg) for cardboard box, 0.37lb(0.17kg) for plastic box.

# Upright Freezer Racks

## For Large 2" Cardboard Boxes

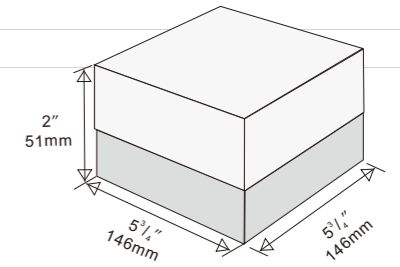

- ◆ Racks are for large 2" cardboard boxes.
- ◆ Constructed of corrosion resistant steel.

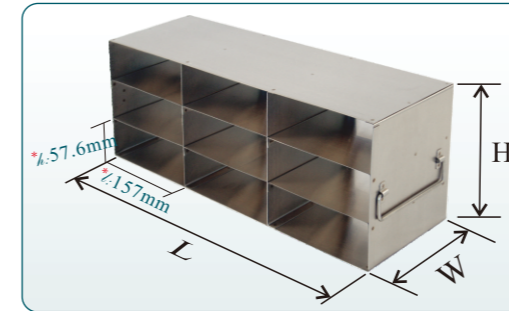

Part Number	Dimension L x H x W	Capacity (Box)	Shipping Weight (lb/Kg)
UFHT-23	13 x 6 <sup>15</sup> / <sub>16</sub> x 5 <sup>7</sup> / <sub>8</sub> inch 330 x 176 x 149 mm	2 x 3 =6	3.8 / 1.71
UFHT-24	13 x 9 <sup>1</sup> / <sub>4</sub> x 5 <sup>7</sup> / <sub>8</sub> inch 330 x 235 x 149 mm	2 x 4 =8	4.7 / 2.12
UFHT-25	13 x 11 <sup>9</sup> / <sub>16</sub> x 5 <sup>7</sup> / <sub>8</sub> inch 330 x 293 x 149 mm	2 x 5 =10	5.6 / 2.52
UFHT-26	13 x 13 <sup>13</sup> / <sub>16</sub> x 5 <sup>7</sup> / <sub>8</sub> inch 330 x 351 x 149 mm	2 x 6 =12	6.5 / 2.95
UFHT-33	19 <sup>3</sup> / <sub>16</sub> x 6 <sup>15</sup> / <sub>16</sub> x 5 <sup>7</sup> / <sub>8</sub> inch 488 x 176 x 149 mm	3 x 3 =9	5.4 / 2.45
UFHT-34	19 <sup>3</sup> / <sub>16</sub> x 9 <sup>1</sup> / <sub>4</sub> x 5 <sup>7</sup> / <sub>8</sub> inch 488 x 235 x 149 mm	3 x 4 =12	6.7 / 3.02
UFHT-35	19 <sup>3</sup> / <sub>16</sub> x 11 <sup>9</sup> / <sub>16</sub> x 5 <sup>7</sup> / <sub>8</sub> inch 488 x 293 x 149 mm	3 x 5 =15	8.0 / 3.63
UFHT-36	19 <sup>3</sup> / <sub>16</sub> x 13 <sup>13</sup> / <sub>16</sub> x 5 <sup>7</sup> / <sub>8</sub> inch 488 x 351 x 149 mm	3 x 6 =18	9.3 / 4.24
UFHT-43	25 <sup>7</sup> / <sub>16</sub> x 6 <sup>15</sup> / <sub>16</sub> x 5 <sup>7</sup> / <sub>8</sub> inch 646 x 176 x 149 mm	4 x 3 =12	7.0 / 3.18
UFHT-44	25 <sup>7</sup> / <sub>16</sub> x 9 <sup>1</sup> / <sub>4</sub> x 5 <sup>7</sup> / <sub>8</sub> inch 646 x 235 x 149 mm	4 x 4 =16	8.7 / 3.93
UFHT-45	25 <sup>7</sup> / <sub>16</sub> x 11 <sup>9</sup> / <sub>16</sub> x 5 <sup>7</sup> / <sub>8</sub> inch 646 x 293 x 149 mm	4 x 5 =20	10.5 / 4.75
UFHT-46	25 <sup>7</sup> / <sub>16</sub> x 13 <sup>13</sup> / <sub>16</sub> x 5 <sup>7</sup> / <sub>8</sub> inch 646 x 351 x 149 mm	4 x 6 =24	12.2 / 5.54

# Upright Freezer Racks

## For Standard 3" Boxes

- ◆ Constructed of corrosion resistant stainless steel.
- ◆ Security lock devices are available for each rack.

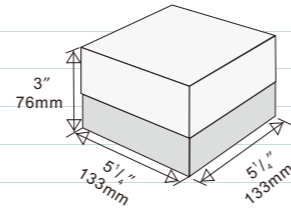

[ Check page 108 for Boxes ]

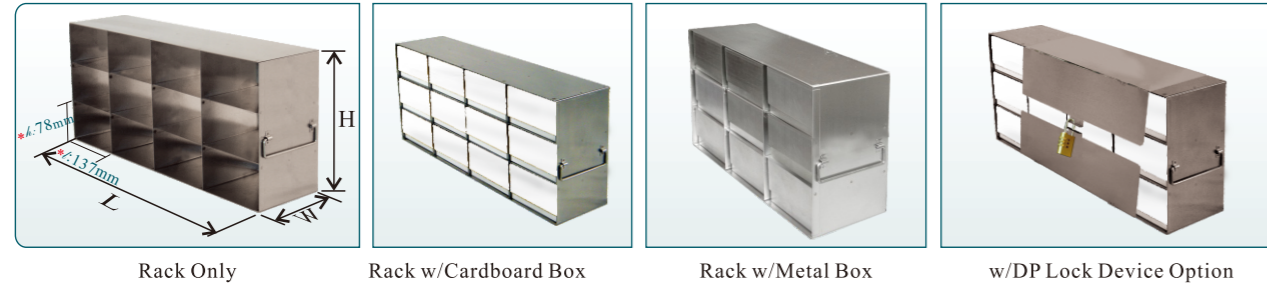

\* UF-223 / UF-323 / UF-423 / UF-523 (∅:82.5mm)

Part Number	Description	Dimension L x H x W	Capacity (Box)	Lock Device Option***	Shipping Weight lb(Kg)
UF-223	Rack Only	11 1/2 x 6 5/8 x 5 1/2 inch 292 x 168 x 140 mm	2 x 2 = 4	DP-1107	2.7(1.23)
UF-223-W-XX**	Rack w/ 3" box and divider				2.7(1.23)+4*ω <sup>1</sup>
UF-233	Rack Only	11 1/2 x 9 3/8 x 5 1/2 inch 292 x 238 x 140 mm	2 x 3 = 6	DP-1110	3.5(1.60)
UF-233-W-XX**	Rack w/ 3" box and divider				3.5(1.60)+6*ω <sup>1</sup>
UF-243	Rack Only	11 1/2 x 12 5/8 x 5 1/2 inch 292 x 321 x 140 mm	2 x 4 = 8	DP-1113	4.4(2.01)
UF-243-W-XX**	Rack w/ 3" box and divider				4.4(2.01)+8*ω <sup>1</sup>
UF-253	Rack Only	11 1/2 x 15 9/16 x 5 1/2 inch 292 x 395 x 140 mm	2 x 5 = 10	DP-1116	5.2(2.38)
UF-253-W-XX**	Rack w/ 3" box and divider				5.2(2.38)+10*ω <sup>1</sup>
UF-323	Rack Only	16 7/8 x 6 5/8 x 5 1/2 inch 429 x 168 x 140 mm	3 x 2 = 6	DP-1607	3.9(1.76)
UF-323-W-XX**	Rack w/ 3" box and divider				3.9(1.76)+6*ω <sup>1</sup>
UF-333	Rack Only	16 7/8 x 9 3/8 x 5 1/2 inch 429 x 238 x 140 mm	3 x 3 = 9	DP-1610	5.0(2.28)
UF-333-W-XX**	Rack w/ 3" box and divider				5.0(2.28)+9*ω <sup>1</sup>
UF-343	Rack Only	16 7/8 x 12 5/8 x 5 1/2 inch 429 x 321 x 140 mm	3 x 4 = 12	DP-1613	6.3(2.84)
UF-343-W-XX**	Rack w/ 3" box and divider				6.3(2.84)+12*ω <sup>1</sup>
UF-353	Rack Only	16 7/8 x 15 9/16 x 5 1/2 inch 429 x 395 x 140 mm	3 x 5 = 15	DP-1616	7.4(3.37)
UF-353-W-XX**	Rack w/ 3" box and divider				7.4(3.37)+15*ω <sup>1</sup>
UF-423	Rack Only	22 3/16 x 6 5/8 x 5 1/2 inch 564 x 168 x 140 mm	4 x 2 = 8	DP-2207	5.0(2.28)
UF-423-W-XX**	Rack w/ 3" box and divider				5.0(2.28)+8*ω <sup>1</sup>
UF-433	Rack Only	22 3/16 x 9 3/8 x 5 1/2 inch 564 x 238 x 140 mm	4 x 3 = 12	DP-2210	6.5(2.95)
UF-433-W-XX**	Rack w/ 3" box and divider				6.5(2.95)+12*ω <sup>1</sup>
UF-443	Rack Only	22 3/16 x 12 5/8 x 5 1/2 inch 564 x 321 x 140 mm	4 x 4 = 16	DP-2213	8.1(3.66)
UF-443-W-XX**	Rack w/ 3" box and divider				8.1(3.66)+16*ω <sup>1</sup>
UF-453	Rack Only	22 3/16 x 15 9/16 x 5 1/2 inch 564 x 395 x 140 mm	4 x 5 = 20	DP-2116	9.7(4.40)
UF-453-W-XX**	Rack w/ 3" box and divider				9.7(4.40)+20*ω <sup>1</sup>
UF-523	Rack Only	27 3/16 x 6 5/8 x 5 1/2 inch 693 x 168 x 140 mm	5 x 2 = 10	DP-2707	6.1(2.76)
UF-523-W-XX**	Rack w/ 3" box and divider				6.1(2.76)+10*ω <sup>1</sup>
UF-533	Rack Only	27 3/16 x 9 3/8 x 5 1/2 inch 693 x 241 x 140 mm	5 x 3 = 15	DP-2710	7.8(3.56)
UF-533-W-XX**	Rack w/ 3" box and divider				7.8(3.56)+15*ω <sup>1</sup>
UF-543	Rack Only	27 3/16 x 12 5/8 x 5 1/2 inch 693 x 321 x 140 mm	5 x 4 = 20	DP-2713	9.8(4.45)
UF-543-W-XX**	Rack w/ 3" box and divider				9.8(4.45)+20*ω <sup>1</sup>

\* To order, replace XX with either 81 or 100 cell divider.

\*\* Lock device is ordered separately.

\*\*\* ω<sup>1</sup>=0.22lb(0.1kg) for cardboard box, 0.37lb(0.17kg) for plastic box, 0.84lb(0.38kg) for stainless steel box, 0.53lb(0.24kg) for aluminum box.

# Upright Freezer Eco-Racks

## For Standard 3" Boxes

- ◆ Designed economically for best cost performance.
- ◆ Constructed of corrosion resistant stainless steel.

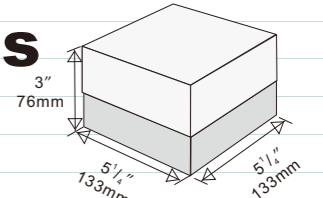

[ Check page 108 for Boxes ]

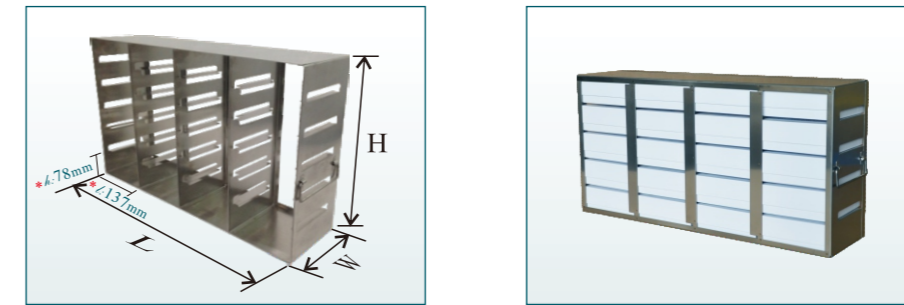

Rack Only

Rack w/Cardboard Box

\*\* UFE-223 / UFE-423 / UFE-523 (∅:82.5mm)

Part Number	Description	Dimension L x H x W	Capacity (Box)	Shipping Weight lb(Kg)
UFE-323	Rack Only	16 13/16 x 6 5/8 x 5 1/2 inch 427 x 168 x 140 mm	3 x 2 = 6	3.3(1.51)
UFE-333	Rack Only	16 13/16 x 9 3/8 x 5 1/2 inch 427 x 238 x 140 mm	3 x 3 = 9	3.9(1.78)
UFE-343	Rack Only	16 13/16 x 12 5/8 x 5 1/2 inch 427 x 321 x 140 mm	3 x 4 = 12	4.6(2.09)
UFE-423	Rack Only	22 1/8 x 6 5/8 x 5 1/2 inch 562 x 168 x 140 mm	4 x 2 = 8	4.3(1.94)
UFE-433	Rack Only	22 1/8 x 9 3/8 x 5 1/2 inch 562 x 238 x 140 mm	4 x 3 = 12	5.0(2.28)
UFE-443	Rack Only	22 1/8 x 12 5/8 x 5 1/2 inch 562 x 321 x 140 mm	4 x 4 = 16	5.9(2.69)
UFE-523	Rack Only	27 3/16 x 6 5/8 x 5 1/2 inch 691 x 168 x 140 mm	5 x 2 = 10	5.2(2.36)
UFE-533	Rack Only	27 3/16 x 9 3/8 x 5 1/2 inch 691 x 241 x 140 mm	5 x 3 = 15	6.1(2.77)

# Upright Freezer Drawer Racks

## For Standard 3" Boxes

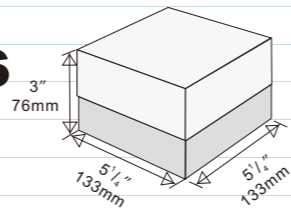

[ Check page 108 for Boxes ]

- ◆ Drawer Racks offer a more organized system for storage and retrieval of samples.
- ◆ Constructed of corrosion resistant stainless steel.
- ◆ Security lock devices are available for each rack.



Rack Only

Rack w/Cardboard Box

Rack w/Metal Box

w/DD Lock Device Option

Part Number	Description	Dimension L x H x W	Capacity (Box)	Lock Device Option***	Shipping Weight lb(Kg)
UFD-223	Rack Only	11 <sup>3</sup> / <sub>8</sub> x 6 <sup>7</sup> / <sub>16</sub> x 5 <sup>1</sup> / <sub>2</sub> inch 289 x 164 x 140 mm	2 x 2 =4	DD-06	4.1(1.84)
UFD-223-W-XX**	Rack w/3" box and divider				4.1(1.84)+4*ω <sup>1</sup>
UFD-233	Rack Only	11 <sup>3</sup> / <sub>8</sub> x 10 <sup>1</sup> / <sub>16</sub> x 5 <sup>1</sup> / <sub>2</sub> inch 289 x 256 x 140 mm	2 x 3 =6	DD-09	5.7(2.59)
UFD-233-W-XX**	Rack w/3" box and divider				5.7(2.59)+6*ω <sup>1</sup>
UFD-243	Rack Only	11 <sup>3</sup> / <sub>8</sub> x 13 <sup>7</sup> / <sub>16</sub> x 5 <sup>1</sup> / <sub>2</sub> inch 289 x 341 x 140 mm	2 x 4 =8	DD-13	7.4(3.35)
UFD-243-W-XX**	Rack w/3" box and divider				7.4(3.35)+8*ω <sup>1</sup>
UFD-323	Rack Only	16 <sup>3</sup> / <sub>4</sub> x 6 <sup>7</sup> / <sub>16</sub> x 5 <sup>1</sup> / <sub>2</sub> inch 426 x 164 x 140 mm	3 x 2 =6	DD-06	5.4(2.46)
UFD-323-W-XX**	Rack w/3" box and divider				5.4(2.46)+6*ω <sup>1</sup>
UFD-333	Rack Only	16 <sup>3</sup> / <sub>4</sub> x 10 <sup>1</sup> / <sub>16</sub> x 5 <sup>1</sup> / <sub>2</sub> inch 426 x 256 x 140 mm	3 x 3 =9	DD-09	7.9(3.58)
UFD-333-W-XX**	Rack w/3" box and divider				7.9(3.58)+9*ω <sup>1</sup>
UFD-343	Rack Only	16 <sup>3</sup> / <sub>4</sub> x 13 <sup>7</sup> / <sub>16</sub> x 5 <sup>1</sup> / <sub>2</sub> inch 426 x 341 x 140 mm	3 x 4 =12	DD-13	10.0(4.54)
UFD-343-W-XX**	Rack w/3" box and divider				10.0(4.54)+12*ω <sup>1</sup>
UFD-423	Rack Only	22 <sup>5</sup> / <sub>16</sub> x 6 <sup>7</sup> / <sub>16</sub> x 5 <sup>1</sup> / <sub>2</sub> inch 566 x 164 x 140 mm	4 x 2 =8	DD-06	6.7(3.05)
UFD-423-W-XX**	Rack w/3" box and divider				6.7(3.05)+8*ω <sup>1</sup>
UFD-433	Rack Only	22 <sup>5</sup> / <sub>16</sub> x 10 <sup>1</sup> / <sub>16</sub> x 5 <sup>1</sup> / <sub>2</sub> inch 566 x 256 x 140 mm	4 x 3 =12	DD-09	9.7(4.39)
UFD-433-W-XX**	Rack w/3" box and divider				9.7(4.39)+12*ω <sup>1</sup>
UFD-443	Rack Only	22 <sup>5</sup> / <sub>16</sub> x 13 <sup>7</sup> / <sub>16</sub> x 5 <sup>1</sup> / <sub>2</sub> inch 566 x 341 x 140 mm	4 x 4 =16	DD-13	12.5(5.69)
UFD-443-W-XX**	Rack w/3" box and divider				12.5(5.69)+16*ω <sup>1</sup>
UFD-453	Rack Only	22 <sup>5</sup> / <sub>16</sub> x 16 <sup>9</sup> / <sub>16</sub> x 5 <sup>1</sup> / <sub>2</sub> inch 566 x 420 x 140 mm	4 x 5 =20	DD-16	15.4(7.00)
UFD-453-W-XX**	Rack w/3" box and divider				15.4(7.00)+20*ω <sup>1</sup>
UFD-523	Rack Only	27 <sup>1</sup> / <sub>16</sub> x 6 <sup>7</sup> / <sub>16</sub> x 5 <sup>1</sup> / <sub>2</sub> inch 687 x 164 x 140 mm	5 x 2 =10	DD-06	8.1(3.69)
UFD-523-W-XX**	Rack w/3" box and divider				8.1(3.69)+10*ω <sup>1</sup>
UFD-533	Rack Only	27 <sup>1</sup> / <sub>16</sub> x 10 <sup>1</sup> / <sub>16</sub> x 5 <sup>1</sup> / <sub>2</sub> inch 687 x 256 x 140 mm	5 x 3 =15	DD-09	11.6(5.25)
UFD-533-W-XX**	Rack w/3" box and divider				11.6(5.25)+15*ω <sup>1</sup>
UFD-543	Rack Only	27 <sup>1</sup> / <sub>16</sub> x 13 <sup>7</sup> / <sub>16</sub> x 5 <sup>1</sup> / <sub>2</sub> inch 687 x 341 x 140 mm	5 x 4 =20	DD-13	15.0(6.81)
UFD-543-W-XX**	Rack w/3" box and divider				15.0(6.81)+20*ω <sup>1</sup>

\* To order, replace XX with either 81 or 100 cell divider.

\*\* Lock device is ordered separately.

\*\*\* ω<sup>1</sup>=0.22lb(0.1kg) for cardboard box, 0.37lb(0.17kg) for plastic box, 0.84lb(0.38kg) for stainless steel box, 0.53lb(0.24kg) for aluminum box.

# Upright Sliding Tray Racks

## For Standard 3" Boxes

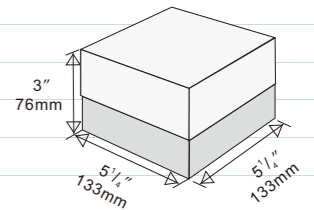

[ Check page 108 for Boxes ]

- ◆ Designed for best cost performance. Function is about the same as our upright freezer drawer racks.
- ◆ Both rack frame and sliding tray are constructed of corrosion resistant stainless steel.
- ◆ Offer a more organized system for storage and retrieval of samples.

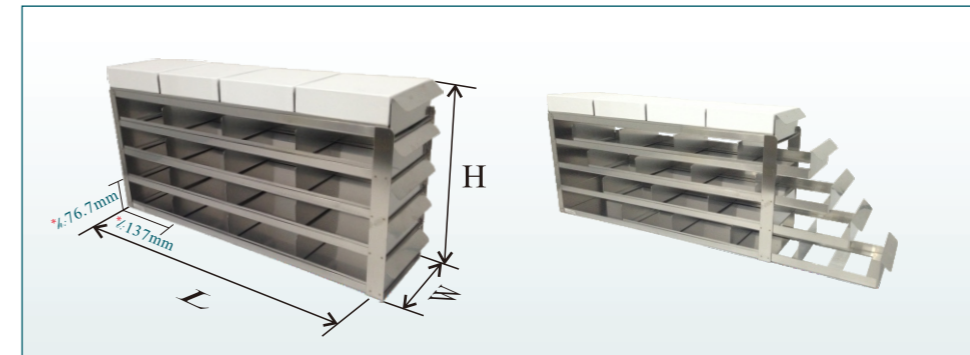

Part Number	Description	Dimension L x H x W	Capacity (Box)	Shipping Weight lb(Kg)
UFS-333	Rack Only	16 <sup>7</sup> / <sub>8</sub> x 9 <sup>1</sup> / <sub>2</sub> x 5 <sup>1</sup> / <sub>2</sub> inch 428 x 241 x 140 mm	3 x 3 =9	4.4(2.70)
UFS-343	Rack Only	16 <sup>7</sup> / <sub>8</sub> x 12 <sup>1</sup> / <sub>16</sub> x 5 <sup>1</sup> / <sub>2</sub> inch 428 x 322 x 140 mm	3 x 4 =12	7.9(3.60)
UFS-423	Rack Only	22 <sup>5</sup> / <sub>8</sub> x 6 <sup>5</sup> / <sub>16</sub> x 5 <sup>1</sup> / <sub>2</sub> inch 568 x 161 x 140 mm	4 x 2 =8	4.9(2.22)
UFS-433	Rack Only	22 <sup>5</sup> / <sub>8</sub> x 9 <sup>1</sup> / <sub>2</sub> x 5 <sup>1</sup> / <sub>2</sub> inch 568 x 241 x 140 mm	4 x 3 =12	7.4(3.37)
UFS-443	Rack Only	22 <sup>5</sup> / <sub>8</sub> x 12 <sup>1</sup> / <sub>16</sub> x 5 <sup>1</sup> / <sub>2</sub> inch 568 x 322 x 140 mm	4 x 4 =16	9.9(4.51)
UFS-453	Rack Only	22 <sup>5</sup> / <sub>8</sub> x 15 <sup>13</sup> / <sub>16</sub> x 5 <sup>1</sup> / <sub>2</sub> inch 568 x 402 x 140 mm	4 x 5 =20	12.5(5.65)
UFS-523	Rack Only	27 <sup>1</sup> / <sub>16</sub> x 6 <sup>5</sup> / <sub>16</sub> x 5 <sup>1</sup> / <sub>2</sub> inch 688 x 161 x 140 mm	5 x 2 =10	5.9(2.68)
UFS-533	Rack Only	27 <sup>1</sup> / <sub>16</sub> x 9 <sup>1</sup> / <sub>2</sub> x 5 <sup>1</sup> / <sub>2</sub> inch 688 x 241 x 140 mm	5 x 3 =15	8.9(4.04)
UFS-543	Rack Only	27 <sup>1</sup> / <sub>16</sub> x 12 <sup>1</sup> / <sub>16</sub> x 5 <sup>1</sup> / <sub>2</sub> inch 688 x 322 x 140 mm	5 x 4 =20	11.9(5.40)

# Vertical Racks for Chest Freezer & Liquid Nitrogen Tanks

(Locking Rod Included)

## For Standard 3" Boxes

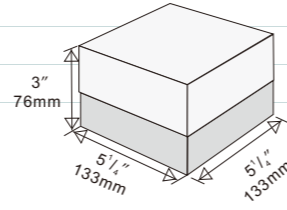

[ Check page 108 for Boxes ]

- ◆ Constructed of corrosion resistant stainless steel.
- ◆ Security lock devices are available for each rack.

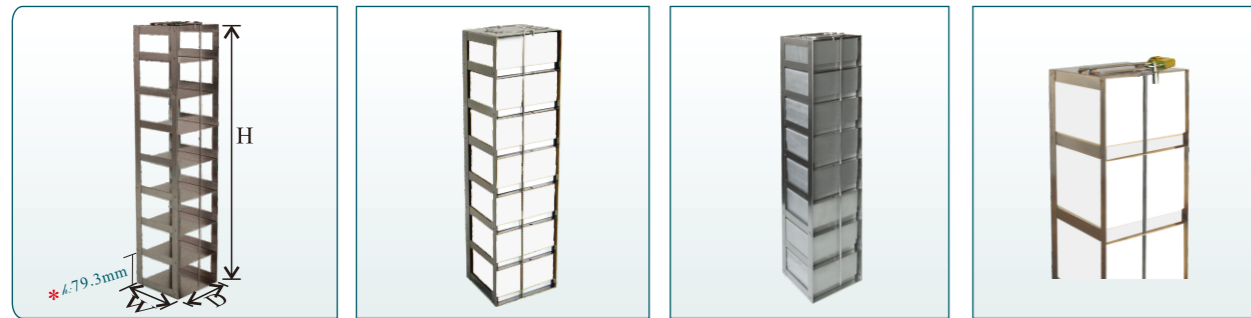

Rack Only

Rack w/Cardboard Box

Rack w/Metal Box

w/DR LockDevice Option

Part Number	Description	Dimension H x W x D	Capacity (Box)	Lock Device Option***	Shipping Weight lb(Kg)
CF-4-3	Rack Only	13 x 5 <sup>1</sup> / <sub>4</sub> x 5 <sup>1</sup> / <sub>2</sub> inch 330 x 143 x 140 mm	4	DR-12	2.1(0.94)
CF-5-3	Rack Only	16 <sup>3</sup> / <sub>16</sub> x 5 <sup>5</sup> / <sub>8</sub> x 5 <sup>1</sup> / <sub>2</sub> inch 411 x 143 x 140 mm	5	DR-15	2.4(1.11)
CF-6-3	Rack Only	19 <sup>3</sup> / <sub>8</sub> x 5 <sup>5</sup> / <sub>8</sub> x 5 <sup>1</sup> / <sub>2</sub> inch 492 x 143 x 140 mm	6	DR-17	2.6(1.20)
CF-7-3	Rack Only	22 <sup>1</sup> / <sub>2</sub> x 5 <sup>5</sup> / <sub>8</sub> x 5 <sup>1</sup> / <sub>2</sub> inch 572 x 143 x 140 mm	7	DR-22	3.2(1.47)
CF-8-3	Rack Only	25 <sup>11</sup> / <sub>16</sub> x 5 <sup>5</sup> / <sub>8</sub> x 5 <sup>1</sup> / <sub>2</sub> inch 653 x 143 x 140 mm	8	DR-25	3.6(1.65)
CF-9-3	Rack Only	28 <sup>1</sup> / <sub>2</sub> x 5 <sup>5</sup> / <sub>8</sub> x 5 <sup>1</sup> / <sub>2</sub> inch 724 x 143 x 140 mm	9	DR-27	4.0(1.81)
CF-10-3	Rack Only	32 <sup>1</sup> / <sub>16</sub> x 5 <sup>5</sup> / <sub>8</sub> x 5 <sup>1</sup> / <sub>2</sub> inch 814 x 143 x 140 mm	10	DR-31	4.4(2.00)
CF-10-3-X'-XX''	Rack w/3" box and divider				4.4(2.00)+10*ω <sup>1</sup>

\* To order, replace XX with either 81 or 100 cell divider.

\*\* Lock device is ordered separately.

\*\*\* ω<sup>1</sup>=0.26lb(0.12kg) for cardboard box, 1.5lb(0.68kg) for stainless steel box, 1lb(0.45kg) for aluminum box.

# Spring Clip Vertical Racks for Chest Freezer & Liquid Nitrogen Tanks

(Locking Rod Included)

## For Standard 3" Boxes

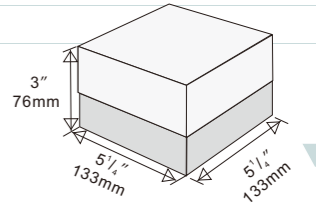

[ Check page 108 for Boxes ]

- ◆ Made of corrosion resistant stainless steel.
- ◆ Spring clips securely hold boxes in rack compartments without using locking rods and allow for easy removal of boxes.
- ◆ Security lock devices are available for each rack.

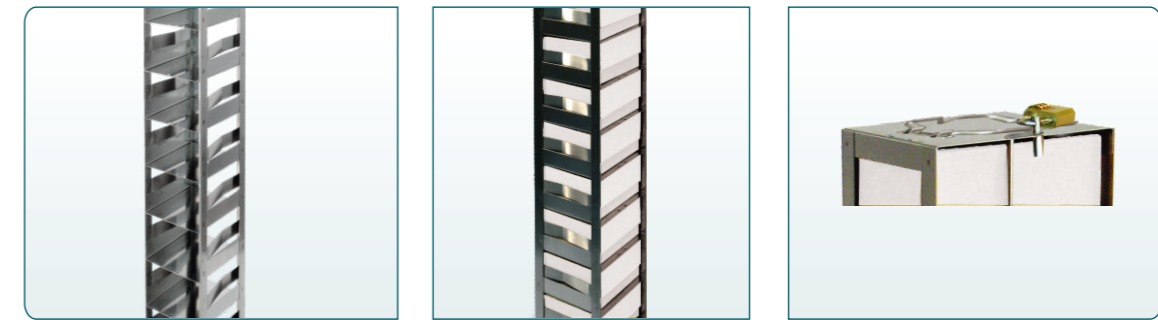

Rack Only

Rack w/Cardboard Box

w/DR LockDevice Option

Part Number	Description	Dimension H x W x D	Capacity (Box)	Lock Device Option ***	Shipping Weight lb(Kg)
CF-7-3-S	Rack Only	22 <sup>1</sup> / <sub>2</sub> x 5 <sup>5</sup> / <sub>8</sub> x 5 <sup>1</sup> / <sub>2</sub> inch 572 x 143 x 140 mm	7	DR-22	3.7(1.69)
CF-8-3-S	Rack Only	25 <sup>11</sup> / <sub>16</sub> x 5 <sup>5</sup> / <sub>8</sub> x 5 <sup>1</sup> / <sub>2</sub> inch 653 x 143 x 140 mm	8	DR-25	4.2(1.9)
CF-9-3-S	Rack Only	28 <sup>1</sup> / <sub>2</sub> x 5 <sup>5</sup> / <sub>8</sub> x 5 <sup>1</sup> / <sub>2</sub> inch 724 x 143 x 140 mm	9	DR-27	4.6(2.1)
CF-10-3-S	Rack Only	32 <sup>1</sup> / <sub>16</sub> x 5 <sup>5</sup> / <sub>8</sub> x 5 <sup>1</sup> / <sub>2</sub> inch 814 x 143 x 140 mm	10	DR-31	5.1(2.3)
CF-10-3-S-X'-XX''	Rack w/3" box and divider				5.1(2.3)+10*ω <sup>1</sup>

\* To order, replace XX with either 81 or 100 cell divider.

\*\* Lock device is ordered separately.

\*\*\* ω<sup>1</sup>=0.26lb(0.12kg) for cardboard box, 1.5lb(0.68kg) for stainless steel box, 1lb(0.45kg) for aluminum box.

# Vertical Half Racks

(Locking Rod Included)

## For Standard 3" Boxes

- ◆ Racks are for standard 3" boxes.
- ◆ Made of corrosion resistant stainless steel.
- ◆ Racks are ideal for light load and easy handling of sample storage in freezers or liquid nitrogen tanks.
- ◆ Locking rod is included for each rack.

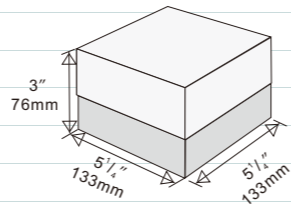

[ Check page 108 for Boxes ]

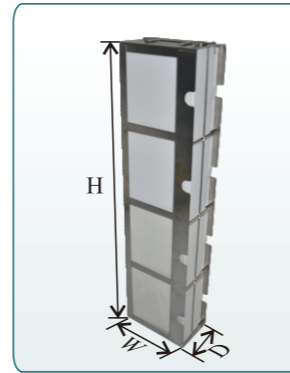

Rack Only

Part Number	Description	Dimension H x D x W	Capacity (Box)	Shipping Weight lb(Kg)
LR-3-3	Rack Only	16 1/2 x 3 1/4 x 5 9/16 inch	3	1.4(0.63)
LR-3-3-X'-XX''	Rack w/3" box and divider	419 x 82 x 141 mm		1.4(0.63)+3*ω'
LR-4-3	Rack Only	21 15/16 x 3 1/4 x 5 9/16 inch	4	1.6(0.71)
LR-4-3-X'-XX''	Rack w/3" box and divider	558 x 82 x 141 mm		1.6(0.71)+4*ω'
LR-5-3	Rack Only	26 3/4 x 3 1/4 x 5 9/16 inch	5	2.1(0.96)
LR-5-3-X'-XX''	Rack w/3" box and divider	679 x 82 x 141 mm		2.1(0.96)+5*ω'
LR-6-3	Rack Only	32 3/16 x 3 1/4 x 5 9/16 inch	6	2.5(1.14)
LR-6-3-X'-XX''	Rack w/3" box and divider	817 x 82 x 141 mm		2.5(1.14)+6*ω'

\* To order, replace X with box type: W-White cardboard box; S-Stainless Steel or A-Aluminum Boxes.

\*\* To order, replace XX with 16,25,36,49,64,81,100 or 144 cell divider.

\*\*\* ω'=0.26lb(0.12kg) for cardboard box, 1.5lb(0.68kg) for stainless steel box, 1lb(0.45kg) for aluminum box.

# Vertical Aluminum Racks for Chest Freezer & Liquid Nitrogen Tanks

(Locking Rod Included)

## For Standard 3" Boxes

- ◆ Racks are for standard 3" boxes.
- ◆ Made of aluminum, these racks offer better temperature uniformity in vapor phase in liquid nitrogen tanks and ideal for long term storage of samples that are accessed infrequently.
- ◆ Security lock devices are available for each rack.

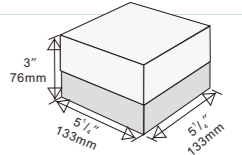

[ Check page 108 for Boxes ]

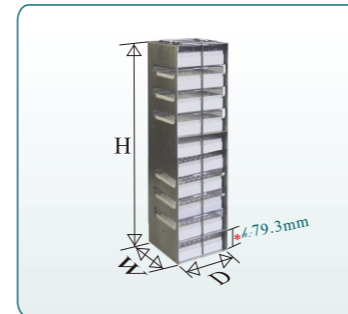

Rack w/Cardboard Box



w/DR LockDevice Option

Part Number	Description	Dimension H x W x D	Capacity (Box)	Lock Device Option***	Shipping Weight lb(Kg)
CFA-4-3	Rack Only	13 x 5 5/8 x 5 1/2 inch 330 x 143 x 140 mm	4	DR-12	1.6(0.72)
CFA-5-3	Rack Only	16 3/16 x 5 5/8 x 5 1/2 inch 411 x 143 x 140 mm	5	DR-15	1.9(0.84)
CFA-6-3	Rack Only	19 5/16 x 5 5/8 x 5 1/2 inch 491 x 143 x 140 mm	6	DR-17	2.1(0.97)
CFA-7-3	Rack Only	22 1/2 x 5 5/8 x 5 1/2 inch 572 x 143 x 140 mm	7	DR-22	2.4(1.10)
CFA-8-3	Rack Only	25 11/16 x 5 5/8 x 5 1/2 inch 653 x 143 x 140 mm	8	DR-25	2.7(1.23)
CFA-9-3	Rack Only	28 1/2 x 5 5/8 x 5 1/2 inch 724 x 143 x 140 mm	9	DR-27	3.2(1.43)
CFA-10-3	Rack Only	32 1/16 x 5 5/8 x 5 1/2 inch 814 x 143 x 140 mm	10	DR-31	3.7(1.70)
CFA-10-3-W-XX''	Rack w/3" box and divider				3.7(1.70)+10*ω'

\* To order, replace XX with either 81 or 100 cell divider.

\*\* Lock device is ordered separately.

\*\*\* ω'=0.26lb(0.12kg) for cardboard box, 1.5lb(0.68kg) for stainless steel box, 1lb(0.45kg) for aluminum box.



# Vertical Mini Racks for Chest Freezers & Liquid Nitrogen Tanks

(Locking Rod Included)  
For 3" Mini Boxes

- ◆ Made of corrosion resistant stainless steel.
- ◆ Locking rod is included for each rack.

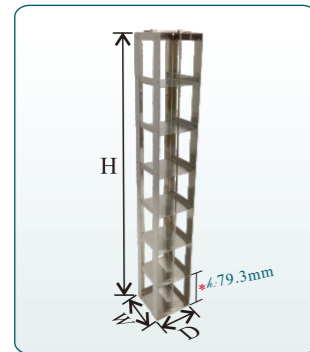

Rack Only

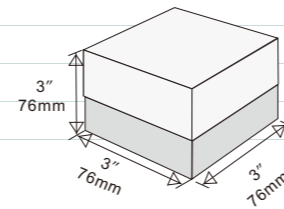

[ Check page 108 for Boxes ]

Part Number	Description	Dimension H x W x D	Capacity (Box)	Lock Device Option**	Shipping Weight lb(kg)
MCF-4-3	Rack Only	13 x 3 <sup>3</sup> / <sub>8</sub> x 3 <sup>1</sup> / <sub>4</sub> inch 330 x 86 x 82 mm	4	DR-12	1.3(0.60)
MCF-4-3-B*	Rack w/box and divider				1.3(0.60)+4*ω <sup>1</sup>
MCF-5-3	Rack Only	16 <sup>3</sup> / <sub>16</sub> x 3 <sup>3</sup> / <sub>8</sub> x 3 <sup>1</sup> / <sub>4</sub> inch 411 x 86 x 82 mm	5	DR-15	1.4(0.65)
MCF-5-3-B*	Rack w/box and divider				1.4(0.65)+5*ω <sup>1</sup>
MCF-6-3	Rack Only	19 <sup>3</sup> / <sub>8</sub> x 3 <sup>3</sup> / <sub>8</sub> x 3 <sup>1</sup> / <sub>4</sub> inch 492 x 86 x 82 mm	6	DR-19	1.6(0.72)
MCF-6-3-B*	Rack w/box and divider				1.6(0.72)+6*ω <sup>1</sup>
MCF-7-3	Rack Only	22 <sup>1</sup> / <sub>2</sub> x 3 <sup>3</sup> / <sub>8</sub> x 3 <sup>1</sup> / <sub>4</sub> inch 572 x 86 x 82 mm	7	DR-22	1.8(0.83)
MCF-7-3-B*	Rack w/box and divider				1.8(0.83)+7*ω <sup>1</sup>
MCF-8-3	Rack Only	25 <sup>11</sup> / <sub>16</sub> x 3 <sup>3</sup> / <sub>8</sub> x 3 <sup>1</sup> / <sub>4</sub> inch 653 x 86 x 82 mm	8	DR-25	2.1(0.93)
MCF-8-3-B*	Rack w/box and divider				2.1(0.93)+8*ω <sup>1</sup>
MCF-9-3	Rack Only	28 <sup>1</sup> / <sub>2</sub> x 3 <sup>3</sup> / <sub>8</sub> x 3 <sup>1</sup> / <sub>4</sub> inch 724 x 86 x 82 mm	9	DR-28	2.3(1.06)
MCF-9-3-B*	Rack w/box and divider				2.3(1.06)+9*ω <sup>1</sup>
MCF-10-3	Rack Only	32 <sup>1</sup> / <sub>16</sub> x 3 <sup>3</sup> / <sub>8</sub> x 3 <sup>1</sup> / <sub>4</sub> inch 814 x 86 x 82 mm	10	DR-31	2.5(1.15)
MCF-10-3-B*	Rack w/box and divider				2.5(1.15)+10*ω <sup>1</sup>

\* Divider's cell opening is 0.5 inch (12.7mm) .

\*\*Lock device is ordered separately.

\*\*\*ω<sup>1</sup>=0.11lb(0.45kg) for cardboard box.

# Vertical Aluminum Mini Racks for Chest Freezers & Liquid Nitrogen Tanks

(Locking Rod Included)

For 3" Mini Boxes

- ◆ Made of aluminum, these racks offer better temperature uniformity in vapor phase in liquid nitrogen tanks and ideal for long term storage of samples that are accessed infrequently.
- ◆ Security lock devices are available for each rack.

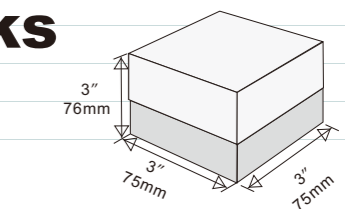

[ Check page 108 for Boxes ]

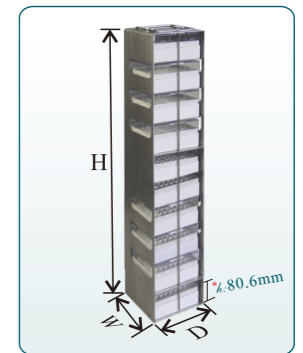

Rack w/Cardboard Box

Part Number	Description	Dimension H x W x D	Capacity (Box)	Lock Device Option**	Shipping Weight lb(kg)
MCFA-7-3	Rack Only	22 <sup>1</sup> / <sub>2</sub> x 3 <sup>3</sup> / <sub>8</sub> x 3 <sup>1</sup> / <sub>4</sub> inch 571 x 86 x 82 mm	7	DR-22	1.4(0.64)
MCFA-7-3-B*	Rack w/box and divider				1.4(0.64)+7*ω <sup>1</sup>
MCFA-8-3	Rack Only	25 <sup>11</sup> / <sub>16</sub> x 3 <sup>3</sup> / <sub>8</sub> x 3 <sup>1</sup> / <sub>4</sub> inch 652 x 86 x 82 mm	8	DR-25	1.6(0.72)
MCFA-8-3-B*	Rack w/box and divider				1.6(0.72)+8*ω <sup>1</sup>
MCFA-9-3	Rack Only	28 <sup>7</sup> / <sub>16</sub> x 3 <sup>3</sup> / <sub>8</sub> x 3 <sup>1</sup> / <sub>4</sub> inch 723 x 86 x 82 mm	9	DR-27	1.8(0.82)
MCFA-9-3-B*	Rack w/box and divider				1.8(0.82)+9*ω <sup>1</sup>
MCFA-10-3	Rack Only	32 x 3 <sup>3</sup> / <sub>8</sub> x 3 <sup>1</sup> / <sub>4</sub> inch 813 x 86 x 82 mm	10	DR-31	2.0(0.90)
MCFA-10-3-B*	Rack w/box and divider				2.0(0.90)+10*ω <sup>1</sup>

\* Divider's cell opening is 0.5 inch (12.7mm) .

\*\*Lock device is ordered separately.

\*\*\*ω<sup>1</sup>=0.11lb(0.45kg) for cardboard box.

## Upright Freezer Racks

### For 3.75" High Standard Boxes

- ◆ Racks are for 3.75" high standard polycarbonate boxes.
- ◆ Made of corrosion resistant stainless steel.

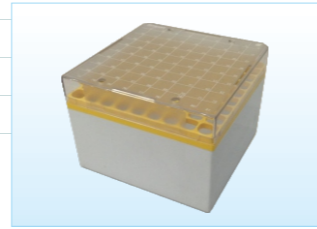

Polycarbonate Plastic Box  
(Check Page 110 for Boxes)

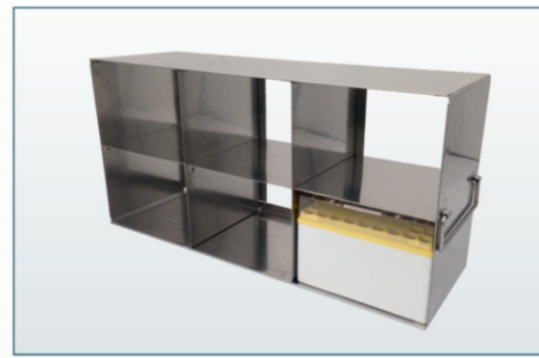
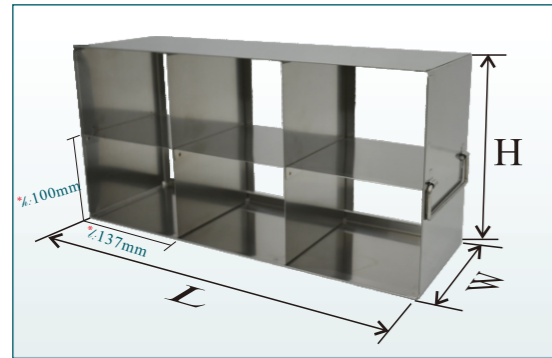

Part Number	Description	Dimension L x H x W	Capacity (Box)	Shipping Weight lb(Kg)
UF-22-375	Rack Only	11 <sup>3</sup> / <sub>8</sub> x 8 <sup>1</sup> / <sub>16</sub> x 5 <sup>1</sup> / <sub>2</sub> inch 289 x 205 x 140 mm	2 x 2 =4	2.9(1.33)
UF-22-375-P	Rack w/3.75" Standard Polycarbonate Boxes			2.9(1.33)+4*ω <sup>1</sup>
UF-23-375	Rack Only	11 <sup>3</sup> / <sub>8</sub> x 12 <sup>1</sup> / <sub>16</sub> x 5 <sup>1</sup> / <sub>2</sub> inch 289 x 307 x 140 mm	2 x 3 =6	3.9(1.78)
UF-23-375-P	Rack w/3.75" Standard Polycarbonate Boxes			3.9(1.78)+6*ω <sup>1</sup>
UF-24-375	Rack Only	11 <sup>3</sup> / <sub>8</sub> x 16 <sup>1</sup> / <sub>16</sub> x 5 <sup>1</sup> / <sub>2</sub> inch 289 x 408 x 140 mm	2 x 4 =8	4.9(2.24)
UF-24-375-P	Rack w/3.75" Standard Polycarbonate Boxes			4.9(2.24)+8*ω <sup>1</sup>
UF-32-375	Rack Only	16 <sup>13</sup> / <sub>16</sub> x 8 <sup>1</sup> / <sub>16</sub> x 5 <sup>1</sup> / <sub>2</sub> inch 427 x 205 x 140 mm	3 x 2 =6	4.1(1.87)
UF-32-375-P	Rack w/3.75" Standard Polycarbonate Boxes			4.1(1.87)+6*ω <sup>1</sup>
UF-33-375	Rack Only	16 <sup>13</sup> / <sub>16</sub> x 12 <sup>1</sup> / <sub>16</sub> x 5 <sup>1</sup> / <sub>2</sub> inch 427 x 307 x 140 mm	3 x 3 =9	5.5(2.51)
UF-33-375-P	Rack w/3.75" Standard Polycarbonate Boxes			5.5(2.51)+9*ω <sup>1</sup>
UF-34-375	Rack Only	16 <sup>13</sup> / <sub>16</sub> x 16 <sup>1</sup> / <sub>16</sub> x 5 <sup>1</sup> / <sub>2</sub> inch 427 x 408 x 140 mm	3 x 4 =12	6.9(3.15)
UF-34-375-P	Rack w/3.75" Standard Polycarbonate Boxes			6.9(3.15)+12*ω <sup>1</sup>
UF-42-375	Rack Only	22 <sup>1</sup> / <sub>8</sub> x 8 <sup>1</sup> / <sub>16</sub> x 5 <sup>1</sup> / <sub>2</sub> inch 562 x 205 x 140 mm	4 x 2 =8	5.3(2.42)
UF-42-375-P	Rack w/3.75" Standard Polycarbonate Boxes			5.3(2.42)+8*ω <sup>1</sup>
UF-43-375	Rack Only	22 <sup>1</sup> / <sub>8</sub> x 12 <sup>1</sup> / <sub>16</sub> x 5 <sup>1</sup> / <sub>2</sub> inch 562 x 307 x 140 mm	4 x 3 =12	7.1(3.24)
UF-43-375-P	Rack w/3.75" Standard Polycarbonate Boxes			7.1(3.24)+12*ω <sup>1</sup>
UF-44-375	Rack Only	22 <sup>1</sup> / <sub>8</sub> x 16 <sup>1</sup> / <sub>16</sub> x 5 <sup>1</sup> / <sub>2</sub> inch 562 x 408 x 140 mm	4 x 4 =16	9.0(4.06)
UF-44-375-P	Rack w/3.75" Standard Polycarbonate Boxes			9.0(4.06)+16*ω <sup>1</sup>
UF-52-375	Rack Only	27 <sup>3</sup> / <sub>16</sub> x 8 <sup>1</sup> / <sub>16</sub> x 5 <sup>1</sup> / <sub>2</sub> inch 691 x 205 x 140 mm	5 x 2 =10	6.5(2.94)
UF-52-375-P	Rack w/3.75" Standard Polycarbonate Boxes			6.5(2.94)+10*ω <sup>1</sup>
UF-53-375	Rack Only	27 <sup>3</sup> / <sub>16</sub> x 12 <sup>1</sup> / <sub>16</sub> x 5 <sup>1</sup> / <sub>2</sub> inch 691 x 307 x 140 mm	5 x 3 =15	8.7(3.94)
UF-53-375-P	Rack w/3.75" Standard Polycarbonate Boxes			8.7(3.94)+15*ω <sup>1</sup>
UF-54-375	Rack Only	27 <sup>3</sup> / <sub>16</sub> x 16 <sup>1</sup> / <sub>16</sub> x 5 <sup>1</sup> / <sub>2</sub> inch 691 x 408 x 140 mm	5 x 4 =20	10.9(4.94)
UF-54-375-P	Rack w/3.75" Standard Polycarbonate Boxes			10.9(4.94)+20*ω <sup>1</sup>

\*ω<sup>1</sup>=0.49lb(0.22kg) for plastic box.

## Upright Freezer Drawer Racks

### For 3.75" High Standard Boxes

- ◆ Racks are for 3.75" high standard polycarbonate boxes.
- ◆ These drawer racks facilitate both access to and storage of samples without having to remove the whole rack from freezer.
- ◆ Made of corrosion resistant stainless steel.

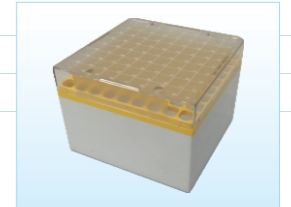

Polycarbonate Plastic Box  
(Check Page 110 for Boxes)

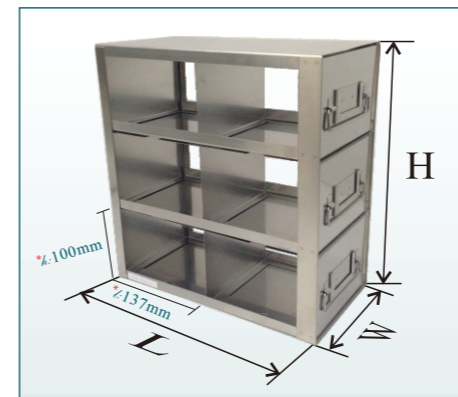

Part Number	Description	Dimension L x H x W	Capacity (Box)	Shipping Weight lb(Kg)
UFD-22-375	Rack Only	11 <sup>1</sup> / <sub>4</sub> x 8 <sup>3</sup> / <sub>8</sub> x 5 <sup>1</sup> / <sub>2</sub> inch 286 x 213 x 140 mm	2 x 2 =4	4.3(1.97)
UFD-22-375-P	Rack w/3.75" Standard Polycarbonate Boxes			4.3(1.97)+7*ω <sup>1</sup>
UFD-23-375	Rack Only	11 <sup>1</sup> / <sub>4</sub> x 12 <sup>1</sup> / <sub>2</sub> x 5 <sup>1</sup> / <sub>2</sub> inch 286 x 318 x 140 mm	2 x 3 =6	7.1(2.81)
UFD-23-375-P	Rack w/3.75" Standard Polycarbonate Boxes			7.1(2.81)+6*ω <sup>1</sup>
UFD-24-375	Rack Only	11 <sup>1</sup> / <sub>4</sub> x 16 <sup>11</sup> / <sub>16</sub> x 5 <sup>1</sup> / <sub>2</sub> inch 286 x 424 x 140 mm	2 x 4 =8	8.1(3.66)
UFD-24-375-P	Rack w/3.75" Standard Polycarbonate Boxes			8.1(3.66)+8*ω <sup>1</sup>
UFD-32-375	Rack Only	16 <sup>5</sup> / <sub>8</sub> x 8 <sup>3</sup> / <sub>8</sub> x 5 <sup>1</sup> / <sub>2</sub> inch 423 x 213 x 140 mm	3 x 2 =6	6.0(2.65)
UFD-32-375-P	Rack w/3.75" Standard Polycarbonate Boxes			6.0(2.65)+6*ω <sup>1</sup>
UFD-33-375	Rack Only	16 <sup>5</sup> / <sub>8</sub> x 12 <sup>1</sup> / <sub>2</sub> x 5 <sup>1</sup> / <sub>2</sub> inch 423 x 318 x 140 mm	3 x 3 =9	8.3(3.78)
UFD-33-375-P	Rack w/3.75" Standard Polycarbonate Boxes			8.3(3.78)+9*ω <sup>1</sup>
UFD-34-375	Rack Only	16 <sup>5</sup> / <sub>8</sub> x 16 <sup>11</sup> / <sub>16</sub> x 5 <sup>1</sup> / <sub>2</sub> inch 423 x 424 x 140 mm	3 x 4 =12	10.8(4.92)
UFD-34-375-P	Rack w/3.75" Standard Polycarbonate Boxes			10.8(4.92)+12*ω <sup>1</sup>
UFD-42-375	Rack Only	22 <sup>3</sup> / <sub>16</sub> x 8 <sup>3</sup> / <sub>8</sub> x 5 <sup>1</sup> / <sub>2</sub> inch 563 x 213 x 140 mm	4 x 2 =8	7.4(3.34)
UFD-42-375-P	Rack w/3.75" Standard Polycarbonate Boxes			7.4(3.34)+8*ω <sup>1</sup>
UFD-43-375	Rack Only	22 <sup>3</sup> / <sub>16</sub> x 12 <sup>1</sup> / <sub>2</sub> x 5 <sup>1</sup> / <sub>2</sub> inch 563 x 318 x 140 mm	4 x 3 =12	10.5(4.76)
UFD-43-375-P	Rack w/3.75" Standard Polycarbonate Boxes			10.5(4.76)+12*ω <sup>1</sup>
UFD-44-375	Rack Only	22 <sup>3</sup> / <sub>16</sub> x 16 <sup>11</sup> / <sub>16</sub> x 5 <sup>1</sup> / <sub>2</sub> inch 563 x 424 x 140 mm	4 x 4 =16	13.6(6.19)
UFD-44-375-P	Rack w/3.75" Standard Polycarbonate Boxes			13.6(6.19)+16*ω <sup>1</sup>
UFD-52-375	Rack Only	26 <sup>7</sup> / <sub>8</sub> x 8 <sup>3</sup> / <sub>8</sub> x 5 <sup>1</sup> / <sub>2</sub> inch 683 x 213 x 140 mm	5 x 2 =10	8.8(3.97)
UFD-52-375-P	Rack w/3.75" Standard Polycarbonate Boxes			8.8(3.97)+10*ω <sup>1</sup>
UFD-53-375	Rack Only	26 <sup>7</sup> / <sub>8</sub> x 12 <sup>1</sup> / <sub>2</sub> x 5 <sup>1</sup> / <sub>2</sub> inch 683 x 318 x 140 mm	5 x 3 =15	11.9(5.40)
UFD-53-375-P	Rack w/3.75" Standard Polycarbonate Boxes			11.9(5.40)+15*ω <sup>1</sup>
UFD-54-375	Rack Only	26 <sup>7</sup> / <sub>8</sub> x 16 <sup>11</sup> / <sub>16</sub> x 5 <sup>1</sup> / <sub>2</sub> inch 683 x 424 x 140 mm	5 x 4 =20	16.2(7.34)
UFD-54-375-P	Rack w/3.75" Standard Polycarbonate Boxes			16.2(7.34)+20*ω <sup>1</sup>

\*ω<sup>1</sup>=0.49lb(0.22kg) for plastic box.

## Vertical Racks

(Locking Rod Included)

### For 3.75" High Standard Boxes

- ◆ Racks are for 3.75" high standard polycarbonate boxes.
- ◆ Made of corrosion resistant stainless steel.

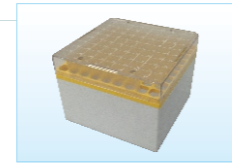

Polycarbonate Plastic Box  
(Check Page 110 for Boxes)

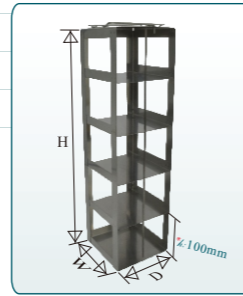

Part Number	Description	Dimension H x W x D	Capacity (Box)	Shipping Weight (lb/Kg)
CF-4-375	Rack Only	16 <sup>1</sup> / <sub>4</sub> x 5 <sup>5</sup> / <sub>8</sub> x 5 <sup>1</sup> / <sub>2</sub> inch	4	3.6(1.64)
CF-4-375-P	Rack w/3.75" box and divider	413 x 143 x 140 mm		3.6(1.64)+4*ω*
CF-5-375	Rack Only	20 <sup>1</sup> / <sub>4</sub> x 5 <sup>5</sup> / <sub>8</sub> x 5 <sup>1</sup> / <sub>2</sub> inch	5	4.5(2.03)
CF-5-375-P	Rack w/3.75" box and divider	514 x 143 x 140 mm		4.5(2.03)+5*ω*
CF-6-375	Rack Only	24 <sup>1</sup> / <sub>4</sub> x 5 <sup>5</sup> / <sub>8</sub> x 5 <sup>1</sup> / <sub>2</sub> inch	6	5.1(2.31)
CF-6-375-P	Rack w/3.75" box and divider	616 x 143 x 140 mm		5.1(2.31)+6*ω*
CF-7-375	Rack Only	28 x 5 <sup>5</sup> / <sub>8</sub> x 5 <sup>1</sup> / <sub>2</sub> inch	7	6.0(2.70)
CF-7-375-P	Rack w/3.75" box and divider	717 x 143 x 140 mm		6.0(2.70)+7*ω*

\*ω<sup>1</sup>= 0.49lb(0.22kg) for plastic box.

## Upright Freezer Racks

### For Large 3.75" High Boxes

- ◆ Made of corrosion resistant stainless steel.

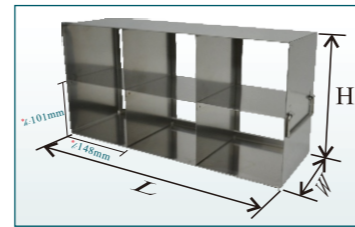
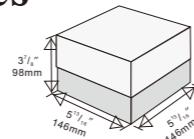

Part Number	Dimension L x H x W	Capacity (Box)	Shipping Weight (lb/Kg)
UF-22-L375	12 <sup>7</sup> / <sub>16</sub> x 8 <sup>1</sup> / <sub>16</sub> x 5 <sup>15</sup> / <sub>16</sub> inch 315.5 x 205 x 151 mm	2 x 2 =4	3.1 / 1.39
UF-23-L375	12 <sup>7</sup> / <sub>16</sub> x 12 <sup>1</sup> / <sub>16</sub> x 5 <sup>15</sup> / <sub>16</sub> inch 315.5 x 307 x 151 mm	2 x 3 =6	4.1 / 1.86
UF-24-L375	12 <sup>7</sup> / <sub>16</sub> x 16 <sup>1</sup> / <sub>16</sub> x 5 <sup>15</sup> / <sub>16</sub> inch 315.5 x 408 x 151 mm	2 x 4 =8	4.7 / 2.14
UF-32-L375	18 <sup>3</sup> / <sub>8</sub> x 8 <sup>1</sup> / <sub>16</sub> x 5 <sup>15</sup> / <sub>16</sub> inch 466 x 205 x 151 mm	3 x 2 =6	4.3 / 1.96
UF-33-L375	18 <sup>3</sup> / <sub>8</sub> x 12 <sup>1</sup> / <sub>16</sub> x 5 <sup>15</sup> / <sub>16</sub> inch 466 x 307 x 151 mm	3 x 3 =9	5.8 / 2.62
UF-34-L375	18 <sup>3</sup> / <sub>8</sub> x 16 <sup>1</sup> / <sub>16</sub> x 5 <sup>15</sup> / <sub>16</sub> inch 466 x 408 x 151 mm	3 x 4 =12	7.2 / 3.28
UF-42-L375	24 <sup>5</sup> / <sub>16</sub> x 8 <sup>1</sup> / <sub>16</sub> x 5 <sup>15</sup> / <sub>16</sub> inch 617 x 205 x 151 mm	4 x 2 =8	6.0 / 2.71
UF-43-L375	24 <sup>5</sup> / <sub>16</sub> x 12 <sup>1</sup> / <sub>16</sub> x 5 <sup>15</sup> / <sub>16</sub> inch 617 x 307 x 151 mm	4 x 3 =12	8.0 / 3.62
UF-44-L375	24 <sup>5</sup> / <sub>16</sub> x 16 <sup>1</sup> / <sub>16</sub> x 5 <sup>15</sup> / <sub>16</sub> inch 617 x 408 x 151 mm	4 x 4 =16	9.9 / 4.48
UF-52-L375	30 <sup>1</sup> / <sub>4</sub> x 8 <sup>1</sup> / <sub>16</sub> x 5 <sup>15</sup> / <sub>16</sub> inch 768 x 205 x 151 mm	5 x 2 =10	7.3 / 3.30
UF-53-L375	30 <sup>1</sup> / <sub>4</sub> x 12 <sup>1</sup> / <sub>16</sub> x 5 <sup>15</sup> / <sub>16</sub> inch 768 x 307 x 151 mm	5 x 3 =15	9.8 / 4.45
UF-54-L375	30 <sup>1</sup> / <sub>4</sub> x 16 <sup>1</sup> / <sub>16</sub> x 5 <sup>15</sup> / <sub>16</sub> inch 768 x 408 x 151 mm	5 x 4 =20	12.1 / 5.50

## Upright Freezer Drawer Racks

### For Large 3.75" High Boxes

- ◆ Made of corrosion resistant stainless steel.

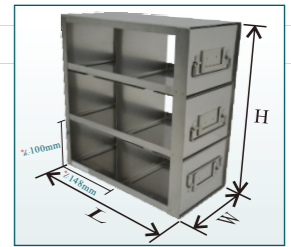
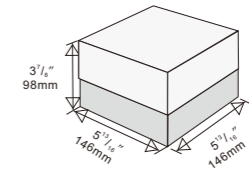

Part Number	Description	Dimension L x H x W	Capacity (Box)	Shipping Weight (lb/Kg)
UFD-22-L375	Rack Only	12 <sup>3</sup> / <sub>16</sub> x 8 <sup>3</sup> / <sub>8</sub> x 6 <sup>1</sup> / <sub>8</sub> inch 310 x 213 x 155 mm	2 x 2 =4	4.9 / 2.22
UFD-23-L375	Rack Only	12 <sup>3</sup> / <sub>16</sub> x 12 <sup>1</sup> / <sub>2</sub> x 6 <sup>1</sup> / <sub>8</sub> inch 310 x 318 x 155 mm	2 x 3 =6	7.0 / 3.17
UFD-24-L375	Rack Only	12 <sup>3</sup> / <sub>16</sub> x 16 <sup>1</sup> / <sub>16</sub> x 6 <sup>1</sup> / <sub>8</sub> inch 310 x 424 x 155 mm	2 x 4 =8	9.1 / 4.11
UFD-32-L375	Rack Only	18 <sup>1</sup> / <sub>16</sub> x 8 <sup>3</sup> / <sub>8</sub> x 6 <sup>1</sup> / <sub>8</sub> inch 459 x 213 x 155 mm	3 x 2 =6	6.6 / 2.98
UFD-33-L375	Rack Only	18 <sup>1</sup> / <sub>16</sub> x 12 <sup>1</sup> / <sub>2</sub> x 6 <sup>1</sup> / <sub>8</sub> inch 459 x 318 x 155 mm	3 x 3 =9	9.4 / 4.25
UFD-34-L375	Rack Only	18 <sup>1</sup> / <sub>16</sub> x 16 <sup>1</sup> / <sub>16</sub> x 6 <sup>1</sup> / <sub>8</sub> inch 459 x 424 x 155 mm	3 x 4 =12	12.2 / 5.54
UFD-42-L375	Rack Only	23 <sup>7</sup> / <sub>8</sub> x 8 <sup>3</sup> / <sub>8</sub> x 6 <sup>1</sup> / <sub>8</sub> inch 609 x 213 x 155 mm	4 x 2 =8	8.3 / 3.76
UFD-43-L375	Rack Only	24 x 12 <sup>1</sup> / <sub>2</sub> x 6 <sup>1</sup> / <sub>8</sub> inch 609 x 318 x 155 mm	4 x 3 =12	11.8 / 5.36
UFD-44-L375	Rack Only	24 x 16 <sup>1</sup> / <sub>16</sub> x 6 <sup>1</sup> / <sub>8</sub> inch 609 x 424 x 155 mm	4 x 4 =16	15.3 / 6.92
UFD-52-L375	Rack Only	29 <sup>13</sup> / <sub>16</sub> x 8 <sup>3</sup> / <sub>8</sub> x 6 <sup>1</sup> / <sub>8</sub> inch 758 x 213 x 155 mm	5 x 2 =10	10.0 / 4.53
UFD-53-L375	Rack Only	29 <sup>13</sup> / <sub>16</sub> x 12 <sup>1</sup> / <sub>2</sub> x 6 <sup>1</sup> / <sub>8</sub> inch 758 x 318 x 155 mm	5 x 3 =15	14.2 / 6.44
UFD-54-L375	Rack Only	29 <sup>13</sup> / <sub>16</sub> x 16 <sup>1</sup> / <sub>16</sub> x 6 <sup>1</sup> / <sub>8</sub> inch 758 x 424 x 155 mm	5 x 4 =20	18.4 / 8.35

## Vertical Racks

(Locking Rod Included)

### For Large 3.75" High Boxes

- ◆ Made of corrosion resistant stainless steel.

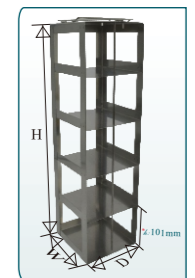
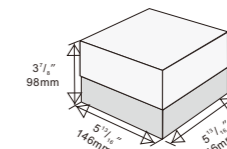

Part Number	Description	Dimension H x W x D	Capacity (Box)	Shipping Weight (lb/Kg)
CF-4-L375	Rack Only	16 <sup>1</sup> / <sub>4</sub> x 6 <sup>1</sup> / <sub>4</sub> x 6 inch 413 x 158 x 153 mm	4	2.5 / 1.12
CF-5-L375	Rack Only	20 <sup>1</sup> / <sub>4</sub> x 6 <sup>1</sup> / <sub>4</sub> x 6 inch 514 x 158 x 153 mm	5	3.0 / 1.34
CF-6-L375	Rack Only	24 <sup>1</sup> / <sub>4</sub> x 6 <sup>1</sup> / <sub>4</sub> x 6 inch 616 x 158 x 153 mm	6	3.4 / 1.55
CF-7-L375	Rack Only	28 <sup>1</sup> / <sub>4</sub> x 6 <sup>1</sup> / <sub>4</sub> x 6 inch 717 x 158 x 153 mm	7	3.9 / 1.76

## Upright Freezer Racks

### Modifiable Racks for 2" and 3" Standard Boxes

- ◆ Removable clip can be adjusted so that the rack can hold both standard 2" and 3" boxes.
- ◆ Constructed of corrosion resistant stainless steel.

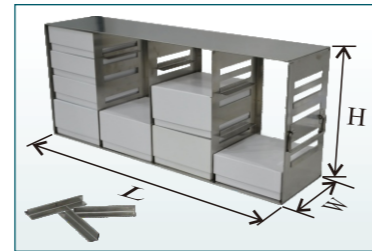

Part Number	Dimension L x H x W	Capacity (Boxes)			Shipping Weight (lb/Kg)	
		2"	3"	2" and 3"		
UFMC-33-2-3	16 <sup>15</sup> / <sub>16</sub> x 6 <sup>5</sup> / <sub>8</sub> x 5 <sup>1</sup> / <sub>2</sub> inch	430.2 x 168.8 x 140 mm	9	6	3 + 3	3.8 / 1.73
UFMC-34-2-3	16 <sup>15</sup> / <sub>16</sub> x 8 <sup>7</sup> / <sub>8</sub> x 5 <sup>1</sup> / <sub>2</sub> inch	430.2 x 225 x 140 mm	12	6	6 + 3	6.7 / 3.04
UFMC-35-2-3	16 <sup>15</sup> / <sub>16</sub> x 11 x 5 <sup>1</sup> / <sub>2</sub> inch	430.2 x 280 x 140 mm	15	6	9 + 3	5.2 / 2.36
UFMC-43-2-3	22 <sup>3</sup> / <sub>8</sub> x 6 <sup>5</sup> / <sub>8</sub> x 5 <sup>1</sup> / <sub>2</sub> inch	569 x 168.8 x 140 mm	12	8	4 + 4	4.9 / 2.24
UFMC-44-2-3	22 <sup>3</sup> / <sub>8</sub> x 8 <sup>7</sup> / <sub>8</sub> x 5 <sup>1</sup> / <sub>2</sub> inch	569 x 225 x 140 mm	16	8	8 + 4	5.8 / 2.63
UFMC-45-2-3	22 <sup>3</sup> / <sub>8</sub> x 11 x 5 <sup>1</sup> / <sub>2</sub> inch	569 x 280 x 140 mm	20	8	12 + 4	6.7 / 3.02
UFMC-46-2-3	22 <sup>3</sup> / <sub>8</sub> x 12 <sup>3</sup> / <sub>8</sub> x 5 <sup>1</sup> / <sub>2</sub> inch	569 x 321 x 140 mm	24	12	12 + 12	5.8 / 2.62
UFMC-53-2-3	27 <sup>1</sup> / <sub>16</sub> x 6 <sup>5</sup> / <sub>8</sub> x 5 <sup>1</sup> / <sub>2</sub> inch	693 x 168.8 x 140 mm	15	10	5 + 5	5.8 / 2.62
UFMC-54-2-3	27 <sup>1</sup> / <sub>16</sub> x 8 <sup>7</sup> / <sub>8</sub> x 5 <sup>1</sup> / <sub>2</sub> inch	693 x 225 x 140 mm	20	10	10 + 5	7.1 / 3.20
UFMC-55-2-3	27 <sup>1</sup> / <sub>16</sub> x 11 x 5 <sup>1</sup> / <sub>2</sub> inch	693 x 280 x 140 mm	25	10	15 + 5	8.1 / 3.68

### For Mixed Storage of 2", 3" and 3.75" Standard Boxes

- ◆ Constructed of corrosion resistant stainless steel.



Part Number	Dimension L x H x W	Capacity (Boxes)			Shipping Weight (lb/Kg)	
		2"	3"	2" and 3"		
UF-306	16 <sup>13</sup> / <sub>16</sub> x 6 <sup>1</sup> / <sub>4</sub> x 5 <sup>1</sup> / <sub>2</sub> inch	427 x 159 x 140 mm	3x3 =9	3x2 =6	3x1 + 3x1	3.3 / 1.49
UF-308	16 <sup>13</sup> / <sub>16</sub> x 8 <sup>1</sup> / <sub>4</sub> x 5 <sup>1</sup> / <sub>2</sub> inch	427 x 210 x 140 mm	3x4 =12	3x2 =6	3x1 + 3x2	3.8 / 1.71
UF-312L	16 <sup>13</sup> / <sub>16</sub> x 12 <sup>3</sup> / <sub>8</sub> x 5 <sup>1</sup> / <sub>8</sub> inch	427 x 315 x 143 mm	3x6 =18	3x4 =12	3x3 + 3x2	5.1 / 2.31
UF-406	22 <sup>1</sup> / <sub>8</sub> x 6 <sup>1</sup> / <sub>4</sub> x 5 <sup>1</sup> / <sub>2</sub> inch	562 x 159 x 140 mm	4x3 =12	4x2 =8	4x1 + 4x1	4.2 / 1.92
UF-408	22 <sup>1</sup> / <sub>8</sub> x 8 <sup>1</sup> / <sub>4</sub> x 5 <sup>1</sup> / <sub>2</sub> inch	562 x 210 x 140 mm	4x4 =16	4x2 =8	4x1 + 4x2	4.8 / 2.18
UF-412	22 <sup>1</sup> / <sub>8</sub> x 9 <sup>1</sup> / <sub>8</sub> x 5 <sup>1</sup> / <sub>2</sub> inch	562 x 238 x 140 mm	4x4 =16	4x3 =12	4x3 + 4x1	5.1 / 2.3
UF-412L	22 <sup>1</sup> / <sub>8</sub> x 12 <sup>3</sup> / <sub>8</sub> x 5 <sup>1</sup> / <sub>8</sub> inch	562 x 315 x 143 mm	4x6 =24	4x3 =12	4x3 + 4x2	6.3 / 2.87
UF-506	27 <sup>3</sup> / <sub>16</sub> x 6 <sup>1</sup> / <sub>4</sub> x 5 <sup>1</sup> / <sub>2</sub> inch	691 x 159 x 140 mm	5x3 =15	5x2 =10	5x1 + 5x1	5.1 / 2.33
UF-508	27 <sup>3</sup> / <sub>16</sub> x 8 <sup>1</sup> / <sub>4</sub> x 5 <sup>1</sup> / <sub>2</sub> inch	691 x 210 x 140 mm	5x4 =20	5x2 =10	5x1 + 5x2	5.9 / 2.66
UF-512L	27 <sup>3</sup> / <sub>16</sub> x 12 <sup>3</sup> / <sub>8</sub> x 5 <sup>1</sup> / <sub>8</sub> inch	691 x 315 x 143 mm	5x6 =30	5x3 =15	5x3 + 5x2	7.7 / 3.50

## Upright Freezer Racks

### For 15ml & 50ml Centrifuge Tubes Boxes

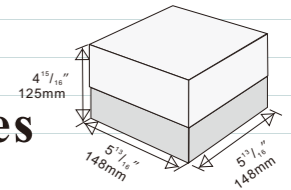

- ◆ Racks are for standard cardboard 15ml & 50ml centrifuge tubes boxes.
- ◆ Made of corrosion resistant stainless steel.
- ◆ Security lock devices are available for each rack.

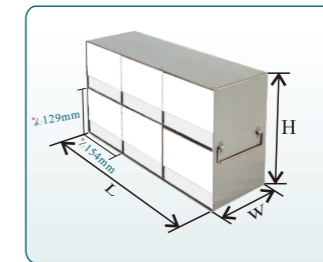

Chest Freezer Rack w/Cardboard Box

w/DR Lock Device Option

Part Number	Description	Dimension L x H x W	Capacity (Box)	Lock Device Option**	Shipping Weight (lb/Kg)
UFLB-22	Rack Only	12 <sup>3</sup> / <sub>4</sub> x 10 <sup>3</sup> / <sub>16</sub> x 5 <sup>7</sup> / <sub>8</sub> inch 324 x 259 x 149 mm	2 x 2 =4	DP-1210	3.7(1.67)
UFLB-22-X*	Rack w/box and divider				3.7(1.67)+4*ω <sup>1</sup>
UFLB-32	Rack Only	18 <sup>13</sup> / <sub>16</sub> x 10 <sup>3</sup> / <sub>16</sub> x 5 <sup>7</sup> / <sub>8</sub> inch 478 x 259 x 149 mm	3 x 2 =6	DP-1810	5.2(2.36)
UFLB-32-X*	Rack w/box and divider				5.2(2.36)+6*ω <sup>1</sup>
UFLB-42	Rack Only	24 <sup>13</sup> / <sub>16</sub> x 10 <sup>3</sup> / <sub>16</sub> x 5 <sup>7</sup> / <sub>8</sub> inch 631 x 259 x 149 mm	4 x 2 =8	DP-2410	6.6(2.98)
UFLB-42-X*	Rack w/box and divider				6.6(2.98)+8*ω <sup>1</sup>

\* To order, replace X with :16 for 50ml tube box or 36 for 15ml tube box.

\*\* Lock device ordered separately.

\*\*\* ω<sup>1</sup>=0.35lb(0.16kg) for cardboard box.

## Chest Freezer Rack

(Locking Rod Included)

### For 15ml & 50ml Centrifuge Tubes Boxes

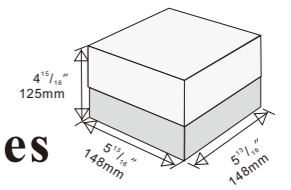

- ◆ Racks are for standard cardboard 15ml & 50ml centrifuge tubes boxes.
- ◆ Made of corrosion resistant stainless steel.
- ◆ Security lock devices are available for each rack.

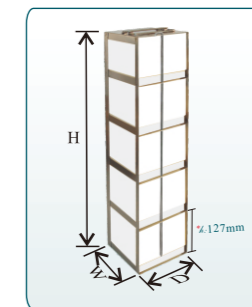

Rack w/Cardboard Box

Rack w/DR Lock Device Option

Part Number	Description	Dimension H x D x W	Capacity (Box)	Lock Device Option*	Shipping Weight (lb/Kg)
CFLB-4	Rack Only	20 <sup>3</sup> / <sub>8</sub> x 6 x 6 <sup>3</sup> / <sub>16</sub> inch 517 x 153 x 157 mm	4	DR-19	2.7(1.22)
CFLB-4-X*	Rack w/box and divider				2.7(1.22)+4*ω <sup>1</sup>
CFLB-5	Rack Only	25 <sup>3</sup> / <sub>8</sub> x 6 x 6 <sup>3</sup> / <sub>16</sub> inch 644 x 153 x 157 mm	5	DR-23	3.2(1.45)
CFLB-5-X*	Rack w/box and divider				3.2(1.45)+5*ω <sup>1</sup>
CFLB-6	Rack Only	30 <sup>3</sup> / <sub>8</sub> x 6 x 6 <sup>3</sup> / <sub>16</sub> inch 771 x 153 x 157 mm	6	DR-29	3.7(1.68)
CFLB-6-X*	Rack w/box and divider				3.7(1.68)+6*ω <sup>1</sup>

\* To order, replace X with :16 for 50ml tube box or 36 for 15ml tube box.

\*\* Lock device ordered separately.

\*\*\* ω<sup>1</sup>=0.35lb(0.16kg) for cardboard box.

## Upright Freezer Drawer Racks

### For Centrifuge Tubes

- ◆ Racks are specially designed to provide an ideal alternative storing large quantities of samples in 15ml and 50ml centrifuge tubes.
- ◆ Made of corrosion resistant stainless steel.
- ◆ Drawer Racks facilitate both access to and storage of samples without having to remove the whole racks from the freezer.
- ◆ Security lock devices are available for each rack.



Rack w/DD Lock Device Option

Content to Store	Rack Length	Rack Height	Number of Drawers	Part Number	Description	Dimension L x H x W	Capacity	Lock Device Option *	Shipping Weight (lb/kg)
15ml	16 1/2 inch 419 mm	4 15/16 inch 126 mm	1	UFD-T15-1	Rack with Drawer for 15ml Centrifuge Tubes	16 11/16 x 4 15/16 x 5 1/2 inch 424 x 126 x 140 mm	60 Tubes (15 ml)	DD-04	4.0 / 1.83
	22 inch 559 mm			UFD-LT15-1		22 7/16 x 4 15/16 x 5 1/2 inch 564 x 126 x 140 mm	80 Tubes (15 ml)		5.2 / 2.35
	26 3/4 inch 679 mm			UFD-XLT15-1		26 15/16 x 4 15/16 x 5 1/2 inch 685 x 126 x 140 mm	104 Tubes (15 ml)		6.1 / 2.75
	16 1/2 inch 419 mm	9 15/16 inch 252 mm	2	UFD-T15-2		16 11/16 x 9 15/16 x 5 1/2 inch 424 x 252 x 140 mm	120 Tubes (15 ml)	DD-09	7.4 / 3.34
	22 inch 559 mm			UFD-LT15-2		22 7/16 x 9 15/16 x 5 1/2 inch 564 x 252 x 140 mm	160 Tubes (15 ml)		9.3 / 4.22
	26 3/4 inch 679 mm			UFD-XLT15-2		26 15/16 x 9 15/16 x 5 1/2 inch 684 x 252 x 140 mm	208 Tubes (15 ml)		10.8 / 4.90
50ml	16 1/2 inch 419 mm	4 15/16 inch 126 mm	1	UFD-T50-1	Rack with Drawer for 50ml Centrifuge Tubes	16 11/16 x 4 15/16 x 5 1/2 inch 424 x 126 x 140 mm	30 Tubes (50 ml)	DD-04	3.9 / 1.78
	22 inch 559 mm			UFD-LT50-1		22 7/16 x 4 15/16 x 5 1/2 inch 564 x 126 x 140 mm	39 Tubes (50 ml)		5.1 / 2.30
	26 3/4 inch 679 mm			UFD-XLT50-1		26 15/16 x 4 15/16 x 5 1/2 inch 685 x 126 x 140 mm	51 Tubes (50 ml)		5.9 / 2.68
	16 1/2 inch 419 mm	9 15/16 inch 252 mm	2	UFD-T50-2		16 11/16 x 9 15/16 x 5 1/2 inch 424 x 252 x 140 mm	60 Tubes (50 ml)	DD-09	7.2 / 3.25
	22 inch 559 mm			UFD-LT50-2		22 7/16 x 9 15/16 x 5 1/2 inch 564 x 252 x 140 mm	78 Tubes (50 ml)		9.1 / 4.12
	26 3/4 inch 679 mm			UFD-XLT50-2		26 15/16 x 9 15/16 x 5 1/2 inch 684 x 252 x 140 mm	102 Tubes (50 ml)		10.4 / 4.76
15/50ml	16 1/2 inch 419 mm	4 15/16 inch 126 mm	2	UFD-T15/50	Rack with Drawer for 15/50ml Centrifuge Tubes	16 11/16 x 9 15/16 x 5 1/2 inch 424 x 252 x 140mm	60 Tubes(15ml)	DD-04	4.6 / 2.10
	22 inch 559 mm			UFD-LT15/50		22 7/16 x 9 15/16 x 5 1/2 inch 564 x 252 x 140mm	80 Tubes(15ml)		5.5 / 2.50
	26 3/4 inch 679 mm			UFD-XLT15/50		26 15/16 x 9 15/16 x 5 1/2 inch 685 x 252 x 140mm	104 Tubes(15ml)		5.5 / 2.50

\* Lock device is ordered separately.

## Upright Freezer Drawer Racks

### For Storage Bottles

- ◆ Racks are specially designed for storing bottles.
- ◆ Made of corrosion resistant stainless steel.
- ◆ Drawer Racks facilitate both access to and storage of samples without having to remove the whole racks from the freezer.
- ◆ Security lock devices are available for each rack.

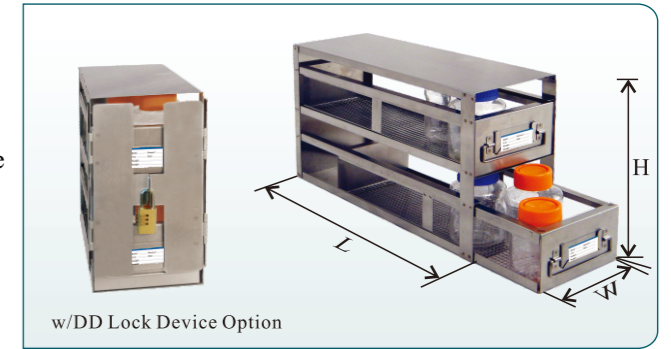

w/DD Lock Device Option

Content to Store	Rack Length	Rack Height	Number of Drawers	Part Number	Description	Dimension L x H x W	Capacity	Lock Device Option *	Shipping Weight (lb/kg)			
Bottle H ≤ 4 15/16 inch 122 mm	16 1/2 inch 419 mm	4 15/16 inch 126 mm	1	UFD-B-1	Rack with 1 Drawer for Bottles	16 11/16 x 4 15/16 x 5 1/2 inch 424 x 126 x 140 mm	Drawer Area: 15 x 4 1/2 inch (Per Drawer) 383 x 114 mm	DD-04	3.4 / 1.54			
				UFD-LB-1		22 7/16 x 4 15/16 x 5 1/2 inch 564 x 126 x 140 mm	Drawer Area: 20 7/8 x 4 1/2 inch (Per Drawer) 523 x 114 mm		4.3 / 1.95			
				UFD-XLB-1		26 15/16 x 4 15/16 x 5 1/2 inch 684 x 126 x 140 mm	Drawer Area: 25 1/2 x 4 1/2 inch (Per Drawer) 644 x 114 mm		5.0 / 2.27			
	Bottle H ≤ 4 15/16 inch 106 mm	16 1/2 inch 419 mm	9 15/16 inch 252 mm	2		UFD-B-2	Rack with 2 Drawer for Bottles	16 11/16 x 9 15/16 x 5 1/2 inch 424 x 252 x 140 mm	Drawer Area: 15 x 4 1/2 inch (Per Drawer) 383 x 114 mm	DD-09	6.1 / 2.77	
						UFD-LB-2		22 7/16 x 9 15/16 x 5 1/2 inch 564 x 252 x 140 mm	Drawer Area: 20 7/8 x 4 1/2 inch (Per Drawer) 523 x 114 mm		7.5 / 3.42	
						UFD-XLB-2		26 15/16 x 9 15/16 x 5 1/2 inch 684 x 252 x 140 mm	Drawer Area: 25 1/2 x 4 1/2 inch (Per Drawer) 644 x 114 mm		8.7 / 3.94	
Bottle H ≤ 2 3/4 inch 70 mm	16 1/2 inch 419 mm	4 1/2 inch 114 mm	1	UFD-B10-1	Rack with 1 Drawer for Bottles	16 11/16 x 4 1/2 x 5 1/2 inch 424 x 114 x 140 mm		Drawer Area: 15 x 4 1/2 inch (Per Drawer) 383 x 114 mm	DD-04	3.0 / 1.34		
				UFD-LB10-1		22 7/16 x 4 1/2 x 5 1/2 inch 564 x 114 x 140 mm		Drawer Area: 20 7/8 x 4 1/2 inch (Per Drawer) 523 x 114 mm		3.7 / 1.68		
				Bottle H ≤ 2 3/4 inch 70 mm		16 1/2 inch 419 mm		9 inch 228 mm		2	UFD-B10-2	Rack with 2 Drawer for Bottles
	UFD-LB10-2	22 7/16 x 9 x 5 1/2 inch 564 x 228 x 140 mm	Drawer Area: 20 7/8 x 4 1/2 inch (Per Drawer) 523 x 114 mm				6.8 / 3.07					
	Bottle H ≤ 2 3/4 inch 70 mm	16 1/2 inch 419 mm	6 1/16 inch 154 mm				2		UFD-B03-2		Rack with 2 Drawer for Bottles	
				UFD-LB03-2		22 7/16 x 6 1/16 x 5 1/2 inch 564 x 154 x 140 mm		Drawer Area: 20 7/8 x 4 1/2 inch (Per Drawer) 523 x 114 mm	6.1 / 2.75			
Bottle H ≤ 2 3/4 inch 70 mm				16 1/2 inch 419 mm	9 1/8 inch 231 mm	3		UFD-B03-3	Rack with 3 Drawer for Bottles	16 11/16 x 9 1/8 x 5 1/2 inch 424 x 231 x 140 mm		
	UFD-LB03-3	22 7/16 x 9 1/8 x 5 1/2 inch 564 x 231 x 140 mm	Drawer Area: 20 7/8 x 4 1/2 inch (Per Drawer) 523 x 114 mm				8.6 / 3.89					

\* Lock device is ordered separately.

## Bin Organize with Lids

### Mixed Use Storage Bins

- ◆ Excellent for organizing -20\* Freezers & cold rooms
- ◆ Can accept a wide variety of tubes, bottles, boxes, etc.
- ◆ Constructed of corrosion resistant stainless steel

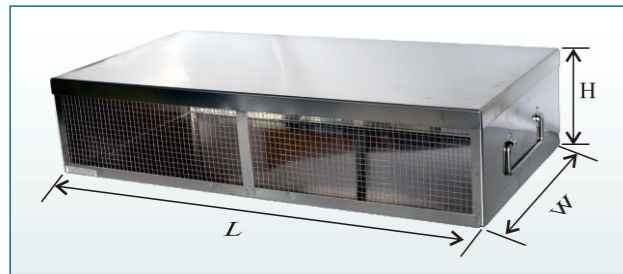

Part Number	Description	Dimension L x H x W	Capacity	Shipping Weight (lb/Kg)
UFT-S04-5	Bin organizer with lids	421 x 120 x 138 mm 16 <sup>9</sup> / <sub>16</sub> x 4 <sup>3</sup> / <sub>4</sub> x 5 <sup>7</sup> / <sub>16</sub> inch	Drawer Area: 16 x 4 <sup>3</sup> / <sub>4</sub> x 5 <sup>7</sup> / <sub>16</sub> inch 407 x 121 x 134 mm	2.8 / 1.29
UFT-S06-5	Bin organizer with lids	421 x 168 x 138 mm 16 <sup>9</sup> / <sub>16</sub> x 6 <sup>3</sup> / <sub>8</sub> x 5 <sup>7</sup> / <sub>16</sub> inch	Drawer Area: 16 x 6 <sup>3</sup> / <sub>8</sub> x 5 <sup>7</sup> / <sub>16</sub> inch 407 x 169 x 134 mm	3.2 / 1.43
UFT-S08-5	Bin organizer with lids	421 x 225 x 138 mm 16 <sup>9</sup> / <sub>16</sub> x 8 <sup>7</sup> / <sub>8</sub> x 5 <sup>7</sup> / <sub>16</sub> inch	Drawer Area: 16 x 8 <sup>7</sup> / <sub>8</sub> x 5 <sup>7</sup> / <sub>16</sub> inch 407 x 224 x 134 mm	3.5 / 1.58
UFT-S11-5	Bin organizer with lids	421 x 280 x 138 mm 16 <sup>9</sup> / <sub>16</sub> x 11 x 5 <sup>7</sup> / <sub>16</sub> inch	Drawer Area: 16 x 11 x 5 <sup>7</sup> / <sub>16</sub> inch 407 x 279 x 134 mm	3.8 / 1.73
UFT-S12-5	Bin organizer with lids	421 x 325 x 138 mm 16 <sup>9</sup> / <sub>16</sub> x 12 <sup>13</sup> / <sub>16</sub> x 5 <sup>7</sup> / <sub>16</sub> inch	Drawer Area: 16 x 12 <sup>13</sup> / <sub>16</sub> x 5 <sup>7</sup> / <sub>16</sub> inch 407 x 324 x 134 mm	3.9 / 1.78
UFT-M04-5	Bin organizer with lids	560 x 120 x 138 mm 22 <sup>1</sup> / <sub>16</sub> x 4 <sup>3</sup> / <sub>4</sub> x 5 <sup>7</sup> / <sub>16</sub> inch	Drawer Area: 21 <sup>1</sup> / <sub>2</sub> x 4 <sup>3</sup> / <sub>4</sub> x 5 <sup>7</sup> / <sub>16</sub> inch 546 x 121 x 134 mm	3.5 / 1.60
UFT-M06-5	Bin organizer with lids	560 x 168 x 138 mm 22 <sup>1</sup> / <sub>16</sub> x 6 <sup>3</sup> / <sub>8</sub> x 5 <sup>7</sup> / <sub>16</sub> inch	Drawer Area: 21 <sup>1</sup> / <sub>2</sub> x 6 <sup>3</sup> / <sub>8</sub> x 5 <sup>7</sup> / <sub>16</sub> inch 546 x 169 x 134 mm	3.9 / 1.76
UFT-M08-5	Bin organizer with lids	560 x 225 x 138 mm 22 <sup>1</sup> / <sub>16</sub> x 8 <sup>7</sup> / <sub>8</sub> x 5 <sup>7</sup> / <sub>16</sub> inch	Drawer Area: 21 <sup>1</sup> / <sub>2</sub> x 8 <sup>7</sup> / <sub>8</sub> x 5 <sup>7</sup> / <sub>16</sub> inch 546 x 224 x 134 mm	4.3 / 1.94
UFT-M11-5	Bin organizer with lids	560 x 280 x 138 mm 22 <sup>1</sup> / <sub>16</sub> x 11 x 5 <sup>7</sup> / <sub>16</sub> inch	Drawer Area: 21 <sup>1</sup> / <sub>2</sub> x 11 x 5 <sup>7</sup> / <sub>16</sub> inch 546 x 279 x 134 mm	4.7 / 2.11
UFT-M12-5	Bin organizer with lids	560 x 325 x 138 mm 22 <sup>1</sup> / <sub>16</sub> x 12 <sup>13</sup> / <sub>16</sub> x 5 <sup>7</sup> / <sub>16</sub> inch	Drawer Area: 21 <sup>1</sup> / <sub>2</sub> x 12 <sup>13</sup> / <sub>16</sub> x 5 <sup>7</sup> / <sub>16</sub> inch 546 x 324 x 134 mm	5.0 / 2.26
UFT-L04-5	Bin organizer with lids	680 x 120 x 138 mm 26 <sup>3</sup> / <sub>4</sub> x 4 <sup>3</sup> / <sub>4</sub> x 5 <sup>7</sup> / <sub>16</sub> inch	Drawer Area: 26 <sup>3</sup> / <sub>4</sub> x 4 <sup>3</sup> / <sub>4</sub> x 5 <sup>7</sup> / <sub>16</sub> inch 666 x 121 x 134 mm	4.2 / 1.89
UFT-L06-5	Bin organizer with lids	680 x 168 x 138 mm 26 <sup>3</sup> / <sub>4</sub> x 6 <sup>3</sup> / <sub>8</sub> x 5 <sup>7</sup> / <sub>16</sub> inch	Drawer Area: 26 <sup>3</sup> / <sub>4</sub> x 6 <sup>3</sup> / <sub>8</sub> x 5 <sup>7</sup> / <sub>16</sub> inch 666 x 169 x 134 mm	4.6 / 2.07
UFT-L08-5	Bin organizer with lids	680 x 225 x 138 mm 26 <sup>3</sup> / <sub>4</sub> x 8 <sup>7</sup> / <sub>8</sub> x 5 <sup>7</sup> / <sub>16</sub> inch	Drawer Area: 26 <sup>3</sup> / <sub>4</sub> x 8 <sup>7</sup> / <sub>8</sub> x 5 <sup>7</sup> / <sub>16</sub> inch 666 x 224 x 134 mm	5.0 / 2.26
UFT-L11-5	Bin organizer with lids	680 x 280 x 138 mm 26 <sup>3</sup> / <sub>4</sub> x 11 x 5 <sup>7</sup> / <sub>16</sub> inch	Drawer Area: 26 <sup>3</sup> / <sub>4</sub> x 11 x 5 <sup>7</sup> / <sub>16</sub> inch 666 x 279 x 134 mm	5.4 / 2.45
UFT-L12-5	Bin organizer with lids	680 x 325 x 138 mm 26 <sup>3</sup> / <sub>4</sub> x 12 <sup>13</sup> / <sub>16</sub> x 5 <sup>7</sup> / <sub>16</sub> inch	Drawer Area: 26 <sup>3</sup> / <sub>4</sub> x 12 <sup>13</sup> / <sub>16</sub> x 5 <sup>7</sup> / <sub>16</sub> inch 666 x 324 x 134 mm	5.8 / 2.62
UFT-S04-11	Bin organizer with lids	421 x 120 x 279 mm 16 <sup>9</sup> / <sub>16</sub> x 4 <sup>3</sup> / <sub>4</sub> x 11 inch	Drawer Area: 16 x 4 <sup>3</sup> / <sub>4</sub> x 10 <sup>3</sup> / <sub>4</sub> inch 406 x 119 x 274 mm	5.2 / 2.35
UFT-S06-11	Bin organizer with lids	421 x 168 x 279 mm 16 <sup>9</sup> / <sub>16</sub> x 6 <sup>3</sup> / <sub>8</sub> x 11 inch	Drawer Area: 16 x 6 <sup>3</sup> / <sub>8</sub> x 10 <sup>3</sup> / <sub>4</sub> inch 406 x 167 x 274 mm	5.7 / 2.58
UFT-S08-11	Bin organizer with lids	421 x 225 x 279 mm 16 <sup>9</sup> / <sub>16</sub> x 8 <sup>7</sup> / <sub>8</sub> x 11 inch	Drawer Area: 16 x 8 <sup>7</sup> / <sub>8</sub> x 10 <sup>3</sup> / <sub>4</sub> inch 406 x 224 x 274 mm	6.2 / 2.83
UFT-S11-11	Bin organizer with lids	421 x 280 x 279 mm 16 <sup>9</sup> / <sub>16</sub> x 11 x 11 inch	Drawer Area: 16 x 11 x 10 <sup>3</sup> / <sub>4</sub> inch 406 x 279 x 274 mm	6.8 / 3.09
UFT-S12-11	Bin organizer with lids	421 x 325 x 279 mm 16 <sup>9</sup> / <sub>16</sub> x 12 <sup>13</sup> / <sub>16</sub> x 11 inch	Drawer Area: 16 x 12 <sup>13</sup> / <sub>16</sub> x 10 <sup>3</sup> / <sub>4</sub> inch 406 x 324 x 274 mm	7.3 / 3.30
UFT-M04-11	Bin organizer with lids	560 x 120 x 279 mm 22 <sup>1</sup> / <sub>16</sub> x 4 <sup>3</sup> / <sub>4</sub> x 11 inch	Drawer Area: 21 <sup>1</sup> / <sub>2</sub> x 4 <sup>3</sup> / <sub>4</sub> x 10 <sup>3</sup> / <sub>4</sub> inch 545 x 119 x 274 mm	6.5 / 2.95
UFT-M06-11	Bin organizer with lids	560 x 168 x 279 mm 22 <sup>1</sup> / <sub>16</sub> x 6 <sup>3</sup> / <sub>8</sub> x 11 inch	Drawer Area: 21 <sup>1</sup> / <sub>2</sub> x 6 <sup>3</sup> / <sub>8</sub> x 10 <sup>3</sup> / <sub>4</sub> inch 545 x 167 x 274 mm	7.1 / 3.20
UFT-M08-11	Bin organizer with lids	560 x 225 x 279 mm 22 <sup>1</sup> / <sub>16</sub> x 8 <sup>7</sup> / <sub>8</sub> x 11 inch	Drawer Area: 21 <sup>1</sup> / <sub>2</sub> x 8 <sup>7</sup> / <sub>8</sub> x 10 <sup>3</sup> / <sub>4</sub> inch 545 x 224 x 274 mm	7.7 / 3.48
UFT-M11-11	Bin organizer with lids	560 x 280 x 279 mm 22 <sup>1</sup> / <sub>16</sub> x 11 x 11 inch	Drawer Area: 21 <sup>1</sup> / <sub>2</sub> x 11 x 10 <sup>3</sup> / <sub>4</sub> inch 545 x 279 x 274 mm	8.3 / 3.76
UFT-M12-11	Bin organizer with lids	560 x 325 x 279 mm 22 <sup>1</sup> / <sub>16</sub> x 12 <sup>13</sup> / <sub>16</sub> x 11 inch	Drawer Area: 21 <sup>1</sup> / <sub>2</sub> x 12 <sup>13</sup> / <sub>16</sub> x 10 <sup>3</sup> / <sub>4</sub> inch 545 x 324 x 274 mm	8.8 / 3.99
UFT-L04-11	Bin organizer with lids	680 x 120 x 279 mm 26 <sup>3</sup> / <sub>4</sub> x 4 <sup>3</sup> / <sub>4</sub> x 11 inch	Drawer Area: 26 <sup>3</sup> / <sub>4</sub> x 4 <sup>3</sup> / <sub>4</sub> x 10 <sup>3</sup> / <sub>4</sub> inch 665 x 119 x 274 mm	7.6 / 3.44
UFT-L06-11	Bin organizer with lids	680 x 168 x 279 mm 26 <sup>3</sup> / <sub>4</sub> x 6 <sup>3</sup> / <sub>8</sub> x 11 inch	Drawer Area: 26 <sup>3</sup> / <sub>4</sub> x 6 <sup>3</sup> / <sub>8</sub> x 10 <sup>3</sup> / <sub>4</sub> inch 665 x 167 x 274 mm	8.2 / 3.71
UFT-L08-11	Bin organizer with lids	680 x 225 x 279 mm 26 <sup>3</sup> / <sub>4</sub> x 8 <sup>7</sup> / <sub>8</sub> x 11 inch	Drawer Area: 26 <sup>3</sup> / <sub>4</sub> x 8 <sup>7</sup> / <sub>8</sub> x 10 <sup>3</sup> / <sub>4</sub> inch 665 x 224 x 274 mm	8.8 / 4.00
UFT-L11-11	Bin organizer with lids	680 x 280 x 279 mm 26 <sup>3</sup> / <sub>4</sub> x 11 x 11 inch	Drawer Area: 26 <sup>3</sup> / <sub>4</sub> x 11 x 10 <sup>3</sup> / <sub>4</sub> inch 665 x 279 x 274 mm	9.5 / 4.30
UFT-L12-11	Bin organizer with lids	680 x 325 x 279 mm 26 <sup>3</sup> / <sub>4</sub> x 12 <sup>13</sup> / <sub>16</sub> x 11 inch	Drawer Area: 26 <sup>3</sup> / <sub>4</sub> x 12 <sup>13</sup> / <sub>16</sub> x 10 <sup>3</sup> / <sub>4</sub> inch 665 x 324 x 274 mm	10.0 / 4.55

## Storage Drawers with Lids

### Mixed Use Storage Drawers

- ◆ Excellent for organizing -20\* Freezers & cold rooms
- ◆ Can accept a wide variety of tubes, bottles, boxes, etc.
- ◆ Constructed of corrosion resistant stainless steel

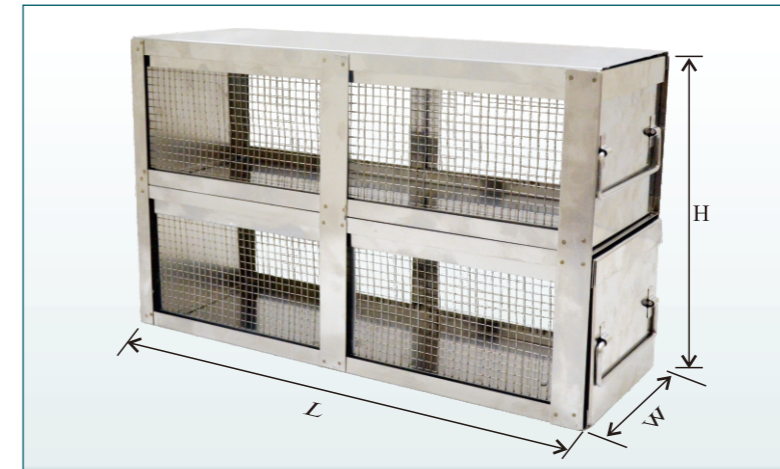

Part Number	Description	Dimension L x H x W	Capacity	Shipping Weight (lb/Kg)
UFTD-SL-5	Drawer style bin organizer	16 <sup>3</sup> / <sub>4</sub> x 9 <sup>15</sup> / <sub>16</sub> x 5 <sup>3</sup> / <sub>8</sub> inch 425 x 252 x 143 mm	Drawer Area: 16 <sup>3</sup> / <sub>8</sub> x 5 x 5 <sup>1</sup> / <sub>2</sub> inch (Per Drawer) 416 x 125 x 141 mm	8.7 / 3.95
UFTD-SH-5	Drawer style bin organizer	16 <sup>3</sup> / <sub>4</sub> x 13 <sup>3</sup> / <sub>4</sub> x 5 <sup>3</sup> / <sub>8</sub> inch 425 x 349 x 143 mm	Drawer Area: 16 <sup>3</sup> / <sub>8</sub> x 6 <sup>13</sup> / <sub>16</sub> x 5 <sup>1</sup> / <sub>2</sub> inch (Per Drawer) 416 x 173 x 141 mm	9.6 / 4.35
UFTD-ML-5	Drawer style bin organizer	22 <sup>1</sup> / <sub>4</sub> x 9 <sup>15</sup> / <sub>16</sub> x 5 <sup>3</sup> / <sub>8</sub> inch 565 x 252 x 143 mm	Drawer Area: 21 <sup>3</sup> / <sub>4</sub> x 5 x 5 <sup>1</sup> / <sub>2</sub> inch (Per Drawer) 553 x 125 x 141 mm	10.8 / 4.91
UFTD-MH-5	Drawer style bin organizer	22 <sup>1</sup> / <sub>4</sub> x 13 <sup>3</sup> / <sub>4</sub> x 5 <sup>3</sup> / <sub>8</sub> inch 565 x 349 x 143 mm	Drawer Area: 21 <sup>3</sup> / <sub>4</sub> x 6 <sup>13</sup> / <sub>16</sub> x 5 <sup>1</sup> / <sub>2</sub> inch (Per Drawer) 553 x 173 x 141 mm	11.9 / 5.35
UFTD-LL-5	Drawer style bin organizer	27 x 9 <sup>15</sup> / <sub>16</sub> x 5 <sup>3</sup> / <sub>8</sub> inch 685.5 x 252 x 143 mm	Drawer Area: 26 <sup>3</sup> / <sub>8</sub> x 5 x 5 <sup>1</sup> / <sub>2</sub> inch (Per Drawer) 677 x 125 x 141 mm	12.8 / 5.81
UFTD-LH-5	Drawer style bin organizer	27 x 9 <sup>15</sup> / <sub>16</sub> x 5 <sup>3</sup> / <sub>8</sub> inch 685.5 x 252 x 143 mm	Drawer Area: 26 <sup>3</sup> / <sub>8</sub> x 6 <sup>13</sup> / <sub>16</sub> x 5 <sup>1</sup> / <sub>2</sub> inch (Per Drawer) 677 x 173 x 141 mm	13.9 / 6.29
UFTD-SL-11	Drawer style bin organizer	16 <sup>3</sup> / <sub>4</sub> x 9 <sup>15</sup> / <sub>16</sub> x 11 <sup>3</sup> / <sub>16</sub> inch 425 x 252 x 284 mm	Drawer Area: 16 <sup>3</sup> / <sub>8</sub> x 4 <sup>7</sup> / <sub>8</sub> x 11 <sup>1</sup> / <sub>8</sub> inch (Per Drawer) 416 x 124 x 282 mm	15.7 / 7.14
UFTD-SH-11	Drawer style bin organizer	16 <sup>3</sup> / <sub>4</sub> x 13 <sup>3</sup> / <sub>4</sub> x 11 <sup>3</sup> / <sub>16</sub> inch 425 x 349 x 284 mm	Drawer Area: 16 <sup>3</sup> / <sub>8</sub> x 6 <sup>3</sup> / <sub>4</sub> x 11 <sup>1</sup> / <sub>8</sub> inch (Per Drawer) 416 x 172 x 282 mm	17.1 / 7.76
UFTD-ML-11	Drawer style bin organizer	22 <sup>1</sup> / <sub>4</sub> x 9 <sup>15</sup> / <sub>16</sub> x 11 <sup>3</sup> / <sub>16</sub> inch 565 x 252 x 284 mm	Drawer Area: 21 <sup>3</sup> / <sub>4</sub> x 4 <sup>7</sup> / <sub>8</sub> x 11 <sup>1</sup> / <sub>8</sub> inch (Per Drawer) 553 x 124 x 282 mm	19.8 / 8.99
UFTD-MH-11	Drawer style bin organizer	22 <sup>1</sup> / <sub>4</sub> x 13 <sup>3</sup> / <sub>4</sub> x 11 <sup>3</sup> / <sub>16</sub> inch 565 x 349 x 284 mm	Drawer Area: 21 <sup>3</sup> / <sub>4</sub> x 6 <sup>3</sup> / <sub>4</sub> x 11 <sup>1</sup> / <sub>8</sub> inch (Per Drawer) 553 x 172 x 282 mm	21.3 / 9.65
UFTD-LL-11	Drawer style bin organizer	27 x 9 <sup>15</sup> / <sub>16</sub> x 11 <sup>3</sup> / <sub>16</sub> inch 685.5 x 252 x 284 mm	Drawer Area: 26 <sup>3</sup> / <sub>8</sub> x 4 <sup>7</sup> / <sub>8</sub> x 11 <sup>1</sup> / <sub>8</sub> inch (Per Drawer) 677 x 124 x 282 mm	23.2 / 10.53
UFTD-LH-11	Drawer style bin organizer	27 x 13 <sup>3</sup> / <sub>4</sub> x 11 <sup>3</sup> / <sub>16</sub> inch 685.5 x 349 x 284 mm	Drawer Area: 26 <sup>3</sup> / <sub>8</sub> x 6 <sup>3</sup> / <sub>4</sub> x 11 <sup>1</sup> / <sub>8</sub> inch (Per Drawer) 677 x 172 x 282 mm	24.8 / 11.23

# Upright Freezer Drawer Racks

## For Blood Sample Tubes

- ◆ Racks are specially designed for storing blood sample tubes.
- ◆ Made of corrosion resistant stainless steel.
- ◆ Drawer Racks facilitate both access to and storage of samples without having to remove the whole racks from the freezer.
- ◆ Security lock devices are available for each rack.



Content to Store	Rack Length	Rack Height	Number of Drawers	Part Number	Description	Dimension L x H x W	Capacity	Lock Device Option*	Shipping Weight (lb/Kg)
8ml - 10ml	16 1/2 inch 419 mm	4 1/2 inch 114 mm	1	UFD-T10-1	Rack with 1 Drawers for 8 ml, 8.5ml, 10ml Tubes (Φ ≤ 3/8 inch H ≤ 4 1/16 inch)	16 11/16 x 4 1/2 x 5 1/2 inch 424 x 114 x 140 mm	60 Tubes of 8ml, 8.5ml or 10ml	DD-04	3.8 / 1.74
	22 inch 559 mm			UFD-LT10-1	80 Tubes of 8ml, 8.5ml or 10ml	4.7 / 2.14			
	16 1/2 inch 419 mm	9 inch 228 mm	2	UFD-T10-2	Rack with 2 Drawers for 8 ml, 8.5ml, 10ml Tubes (Φ ≤ 3/8 inch H ≤ 4 1/16 inch)	16 11/16 x 9 x 5 1/2 inch 424 x 228 x 140 mm	120 Tubes of 8ml, 8.5ml or 10ml	DD-06	6.8 / 3.10
	22 inch 559 mm			UFD-LT10-2	160 Tubes of 8ml, 8.5ml or 10ml	8.4 / 3.79			
4ml - 7ml	16 1/2 inch 419 mm	4 1/2 inch 114 mm	1	UFD-T06-1	Rack with 1 Drawers for 4 ml, 4.5ml, 6ml, 7ml Tubes (Φ ≤ 1/2 inch H ≤ 4 1/16 inch)	16 11/16 x 4 1/2 x 5 1/2 inch 424 x 114 x 140 mm	85 Tubes of 4ml, 4.5ml or 7ml	DD-04	3.6 / 1.64
	22 inch 559 mm			UFD-LT06-1	115 Tubes of 4ml, 4.5ml, 6ml or 7ml	4.6 / 2.09			
	16 1/2 inch 419 mm	9 inch 228 mm	2	UFD-T06-2	Rack with 2 Drawers for 4 ml, 4.5ml, 6ml, 7ml Tubes (Φ ≤ 1/2 inch H ≤ 4 1/16 inch)	16 11/16 x 9 x 5 1/2 inch 424 x 228 x 140 mm	170 Tubes of 4ml, 4.5ml, 6ml or 7ml	DD-06	6.5 / 2.94
	22 inch 559 mm			UFD-LT06-2	230 Tubes of 4ml, 4.5ml, 6ml or 7ml	8.1 / 3.68			
3ml	16 1/2 inch 419 mm	6 1/16 inch 154 mm	2	UFD-T03-2	Rack with 2 Drawers for 3ml Tubes (Φ ≤ 7/16 inch H ≤ 2 3/4 inch)	16 11/16 x 6 1/16 x 5 1/2 inch 424 x 154 x 140 mm	180 Tubes of 3ml	DD-03	6.2 / 2.83
	22 inch 559 mm			UFD-LT03-2	250 Tubes of 3ml	7.9 / 3.59			
	16 1/2 inch 419 mm	9 1/8 inch 231 mm	3	UFD-T03-3	Rack with 3 Drawers for 3ml Tubes (Φ ≤ 7/16 inch H ≤ 2 3/4 inch)	16 11/16 x 9 1/8 x 5 1/2 inch 424 x 231 x 140 mm	270 Tubes of 3ml	DD-06	8.9 / 4.05
	22 inch 559 mm			UFD-LT03-3	375 Tubes of 3ml	11.4 / 5.16			
1ml	16 1/2 inch 419 mm	6 1/16 inch 154 mm	2	UFD-T01-2	Rack with 2 Drawers for 1ml Tubes (Φ ≤ 7/16 inch H ≤ 2 3/4 inch)	16 11/16 x 6 1/16 x 5 1/2 inch 424 x 154 x 140 mm	240 Tubes of 1ml	DD-03	6.3 / 2.85
	22 inch 559 mm			UFD-LT01-2	324 Tubes of 1ml	7.9 / 3.58			
	16 1/2 inch 419 mm	9 1/8 inch 231 mm	3	UFD-T01-3	Rack with 3 Drawers for 1ml Tubes (Φ ≤ 7/16 inch H ≤ 2 3/4 inch)	16 11/16 x 9 1/8 x 5 1/2 inch 424 x 231 x 140 mm	360 Tubes of 1ml	DD-06	9.0 / 4.08
	22 inch 559 mm			UFD-LT01-3	486 Tubes of 1ml	11.3 / 5.13			

\*Lock device is ordered separately.

# Upright Freezer Racks

## For 96-Well & 384-Well Microtiter Plates

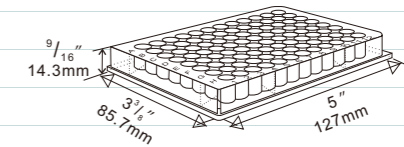

- ◆ Made of corrosion resistant stainless steel.
- ◆ Locking rods are included.
- ◆ Security lock devices are available for each rack.

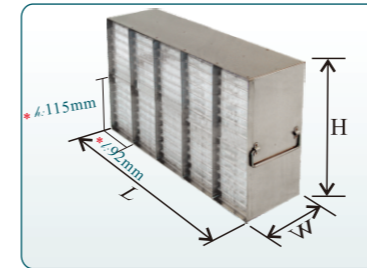

\*UFML-311L / UFML-411L / UFML-511L / UFML-611L / UFML-711L (k:138mm) UFML-312L / UFML-412L / UFML-512L / UFML-612L / UFML-712L (k:151mm) UFML-316L / UFML-416L / UFML-516L / UFML-616L / UFML-716L (k:202mm) UFML-319L / UFML-419L / UFML-519L / UFML-619L / UFML-719L (k:239mm)

Part Number	Dimension L x H x W	Capacity (Plate)	Lock Device Option*	Shipping Weight (lb/Kg)
UFMP-309L	11 1/2 x 9 3/16 x 5 1/2 inch 292 x 233 x 140 mm	42 Plates w/lids 48 Plates w/o lids	DP-1109	3.8 / 1.71
UFMP-311L	11 1/2 x 11 x 5 1/2 inch 292 x 280 x 140 mm	51 Plates w/lids 54 Plates w/o lids	DP-1111	4.2 / 1.89
UFMP-312L	11 1/2 x 12 x 5 1/2 inch 292 x 305 x 140 mm	54 Plates w/lids 60 Plates w/o lids	DP-1112	4.4 / 1.99
UFMP-316L	11 1/2 x 16 x 5 1/2 inch 292 x 407 x 140 mm	72 Plates w/lids 84 Plates w/o lids	DP-1116	5.3 / 2.40
UFMP-319L	11 1/2 x 18 15/16 x 5 1/2 inch 292 x 481 x 140 mm	84 Plates w/lids 96 Plates w/o lids	DP-1119	5.9 / 2.69
UFMP-409L	15 3/16 x 9 3/16 x 5 1/2 inch 386 x 233 x 140 mm	56 Plates w/lids 64 Plates w/o lids	DP-1409	4.9 / 2.20
UFMP-411L	15 3/16 x 11 x 5 1/2 inch 386 x 280 x 140 mm	64 Plates w/lids 80 Plates w/o lids	DP-1411	5.4 / 2.43
UFMP-412L	15 3/16 x 12 x 5 1/2 inch 386 x 305 x 140 mm	72 Plates w/lids 84 Plates w/o lids	DP-1412	5.6 / 2.55
UFMP-416L	15 3/16 x 16 x 5 1/2 inch 386 x 407 x 140 mm	96 Plates w/lids 112 Plates w/o lids	DP-1416	6.7 / 3.06
UFMP-419L	15 3/16 x 18 15/16 x 5 1/2 inch 386 x 481 x 140 mm	116 Plates w/lids 136 Plates w/o lids	DP-1419	7.5 / 3.42
UFMP-509L	18 13/16 x 9 3/16 x 5 1/2 inch 478 x 233 x 140 mm	70 Plates w/lids 80 Plates w/o lids	DP-1809	6.1 / 2.77
UFMP-511L	18 13/16 x 11 x 5 1/2 inch 478 x 280 x 140 mm	85 Plates w/lids 95 Plates w/o lids	DP-1811	6.7 / 3.04
UFMP-512L	18 13/16 x 12 x 5 1/2 inch 478 x 305 x 140 mm	90 Plates w/lids 100 Plates w/o lids	DP-1812	6.9 / 3.11
UFMP-516L	18 13/16 x 16 x 5 1/2 inch 478 x 407 x 140 mm	120 Plates w/lids 140 Plates w/o lids	DP-1816	8.2 / 3.72
UFMP-519L	18 13/16 x 18 15/16 x 5 1/2 inch 478 x 481 x 140 mm	140 Plates w/lids 170 Plates w/o lids	DP-1819	9.2 / 4.16
UFMP-609L	22 1/2 x 9 3/16 x 5 1/2 inch 571 x 233 x 140 mm	84 Plates w/lids 96 Plates w/o lids	DP-2209	7.2 / 3.27
UFMP-611L	22 1/2 x 11 x 5 1/2 inch 571 x 280 x 140 mm	96 Plates w/lids 120 Plates w/o lids	DP-2211	7.9 / 3.59
UFMP-612L	22 1/2 x 12 x 5 1/2 inch 571 x 305 x 140 mm	108 Plates w/lids 132 Plates w/o lids	DP-2212	8.1 / 3.67
UFMP-616L	22 1/2 x 16 x 5 1/2 inch 571 x 407 x 140 mm	144 Plates w/lids 168 Plates w/o lids	DP-2216	9.7 / 4.38
UFMP-619L	22 1/2 x 18 15/16 x 5 1/2 inch 571 x 481 x 140 mm	168 Plates w/lids 204 Plates w/o lids	DP-2219	10.8 / 4.90
UFMP-709L	26 1/8 x 9 3/16 x 5 1/2 inch 664 x 233 x 140 mm	98 Plates w/lids 112 Plates w/o lids	DP-2609	8.3 / 3.77
UFMP-711L	26 1/8 x 11 x 5 1/2 inch 664 x 280 x 140 mm	112 Plates w/lids 140 Plates w/o lids	DP-2611	9.1 / 4.13
UFMP-712L	26 1/8 x 12 x 5 1/2 inch 664 x 305 x 140 mm	126 Plates w/lids 154 Plates w/o lids	DP-2612	9.3 / 4.22
UFMP-716L	26 1/8 x 16 x 5 1/2 inch 664 x 407 x 140 mm	168 Plates w/lids 196 Plates w/o lids	DP-2616	11.1 / 5.05
UFMP-719L	26 1/8 x 18 15/16 x 5 1/2 inch 664 x 481 x 140 mm	196 Plates w/lids 238 Plates w/o lids	DP-2619	12.4 / 5.64

\* Lock device is ordered separately.

## Upright Freezer Drawer Racks

For 96-Well & 384-Well Microtiter Plates

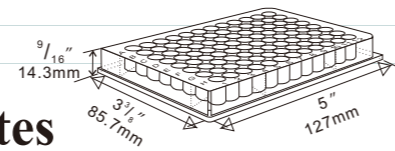

- ◆ Made of corrosion resistant stainless steel.
- ◆ Drawer racks allow easy access to fewer microtiter plates at a time thus protecting other samples in the rack from warming up.
- ◆ Security lock devices are available for each rack.

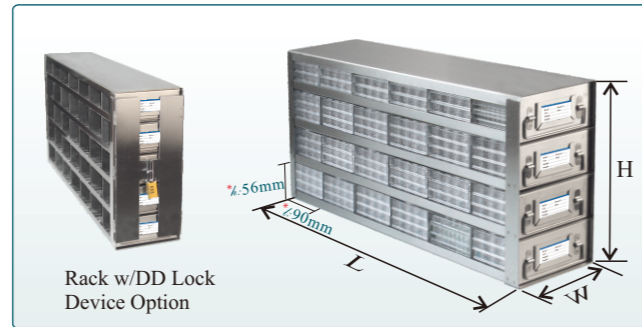

Part Number	Description	Dimension L x H x W	Capacity	Lock Device Option*	Shipping Weight (lb/Kg)
			96-Well & 384-Well Microtiter Plates		
UFDMP-33	Rack w/3 drawers (3 compartments per drawer) for Microtiter Plates	11 <sup>1</sup> / <sub>8</sub> x 7 <sup>5</sup> / <sub>16</sub> x 5 <sup>7</sup> / <sub>16</sub> inch 282 x 186 x 138 mm	27 w/lids 36 w/o lids	DD-06	5.4 / 2.45
UFDMP-34	Rack w/4 drawers (3 compartments per drawer) for Microtiter Plates	11 <sup>1</sup> / <sub>8</sub> x 9 <sup>1</sup> / <sub>4</sub> x 5 <sup>7</sup> / <sub>16</sub> inch 282 x 247 x 138 mm	36 w/lids 48 w/o lids	DD-09	6.9 / 3.13
UFDMP-35	Rack w/5 drawers (3 compartments per drawer) for Microtiter Plates	11 <sup>1</sup> / <sub>8</sub> x 12 <sup>1</sup> / <sub>8</sub> x 5 <sup>7</sup> / <sub>16</sub> inch 282 x 308 x 138 mm	45 w/lids 60 w/o lids	DD-11	8.6 / 3.90
UFDMP-36	Rack w/6 drawers (3 compartments per drawer) for Microtiter Plates	11 <sup>1</sup> / <sub>8</sub> x 14 <sup>1</sup> / <sub>2</sub> x 5 <sup>7</sup> / <sub>16</sub> inch 282 x 368 x 138 mm	54 w/lids 72 w/o lids	DD-14	10.2 / 4.64
UFDMP-43	Rack w/3 drawers (4 compartments per drawer) for Microtiter Plates	14 <sup>3</sup> / <sub>8</sub> x 7 <sup>5</sup> / <sub>16</sub> x 5 <sup>7</sup> / <sub>16</sub> inch 372 x 186 x 138 mm	36 w/lids 48 w/o lids	DD-06	6.8 / 3.10
UFDMP-44	Rack w/4 drawers (4 compartments per drawer) for Microtiter Plates	14 <sup>3</sup> / <sub>8</sub> x 9 <sup>3</sup> / <sub>4</sub> x 5 <sup>7</sup> / <sub>16</sub> inch 372 x 247 x 138 mm	48 w/lids 64 w/o lids	DD-09	8.9 / 4.02
UFDMP-45	Rack w/5 drawers (4 compartments per drawer) for Microtiter Plates	14 <sup>3</sup> / <sub>8</sub> x 12 <sup>1</sup> / <sub>8</sub> x 5 <sup>7</sup> / <sub>16</sub> inch 372 x 308 x 138 mm	60 w/lids 80 w/o lids	DD-11	10.9 / 4.94
UFDMP-46	Rack w/6 drawers (4 compartments per drawer) for Microtiter Plates	14 <sup>3</sup> / <sub>8</sub> x 14 <sup>1</sup> / <sub>2</sub> x 5 <sup>7</sup> / <sub>16</sub> inch 372 x 368 x 138 mm	72 w/lids 96 w/o lids	DD-14	12.9 / 5.86
UFDMP-53	Rack w/3 drawers (4 compartments per drawer) for Microtiter Plates	18 <sup>3</sup> / <sub>16</sub> x 7 <sup>5</sup> / <sub>16</sub> x 5 <sup>7</sup> / <sub>16</sub> inch 462 x 168 x 138 mm	45 w/lids 60 w/o lids	DD-06	8.2 / 3.70
UFDMP-54	Rack w/4 drawers (5 compartments per drawer) for Microtiter Plates	18 <sup>3</sup> / <sub>16</sub> x 9 <sup>3</sup> / <sub>4</sub> x 5 <sup>7</sup> / <sub>16</sub> inch 462 x 247 x 138 mm	60 w/lids 80 w/o lids	DD-09	10.6 / 4.79
UFDMP-55	Rack w/5 drawers (5 compartments per drawer) for Microtiter Plates	18 <sup>3</sup> / <sub>16</sub> x 12 <sup>1</sup> / <sub>16</sub> x 5 <sup>7</sup> / <sub>16</sub> inch 462 x 308 x 138 mm	75 w/lids 100 w/o lids	DD-11	13.0 / 5.90
UFDMP-56	Rack w/6 drawers (5 compartments per drawer) for Microtiter Plates	18 <sup>3</sup> / <sub>16</sub> x 14 <sup>1</sup> / <sub>2</sub> x 5 <sup>7</sup> / <sub>16</sub> inch 462 x 368 x 138 mm	90 w/lids 120 w/o lids	DD-14	15.4 / 7.00
UFDMP-63	Rack w/3 drawers (6 compartments per drawer) for Microtiter Plates	21 <sup>3</sup> / <sub>4</sub> x 7 <sup>5</sup> / <sub>16</sub> x 5 <sup>7</sup> / <sub>16</sub> inch 552 x 186 x 138 mm	54 w/lids 72 w/o lids	DD-06	9.7 / 4.42
UFDMP-64	Rack w/4 drawers (6 compartments per drawer) for Microtiter Plates	21 <sup>3</sup> / <sub>4</sub> x 9 <sup>3</sup> / <sub>4</sub> x 5 <sup>7</sup> / <sub>16</sub> inch 552 x 247 x 138 mm	72 w/lids 96 w/o lids	DD-09	12.6 / 5.73
UFDMP-65	Rack w/5 drawers (6 compartments per drawer) for Microtiter Plates	21 <sup>3</sup> / <sub>4</sub> x 12 <sup>1</sup> / <sub>8</sub> x 5 <sup>7</sup> / <sub>16</sub> inch 552 x 308 x 138 mm	90 w/lids 120 w/o lids	DD-11	15.5 / 7.05
UFDMP-66	Rack w/6 drawers (6 compartments per drawer) for Microtiter Plates	21 <sup>3</sup> / <sub>4</sub> x 14 <sup>1</sup> / <sub>2</sub> x 5 <sup>7</sup> / <sub>16</sub> inch 552 x 368 x 138 mm	108 w/lids 144 w/o lids	DD-14	17.9 / 8.14
UFDMP-73	Rack w/3 drawers (7 compartments per drawer) for Microtiter Plates	25 <sup>1</sup> / <sub>4</sub> x 7 <sup>5</sup> / <sub>16</sub> x 5 <sup>7</sup> / <sub>16</sub> inch 642 x 186 x 138 mm	63 w/lids 84 w/o lids	DD-06	11.0 / 4.97
UFDMP-74	Rack w/4 drawers (7 compartments per drawer) for Microtiter Plates	25 <sup>1</sup> / <sub>4</sub> x 9 <sup>3</sup> / <sub>4</sub> x 5 <sup>7</sup> / <sub>16</sub> inch 642 x 247 x 138 mm	84 w/lids 112 w/o lids	DD-09	14.2 / 6.43
UFDMP-75	Rack w/5 drawers (7 compartments per drawer) for Microtiter Plates	25 <sup>1</sup> / <sub>4</sub> x 12 <sup>1</sup> / <sub>8</sub> x 5 <sup>7</sup> / <sub>16</sub> inch 642 x 308 x 138 mm	105 w/lids 140 w/o lids	DD-11	17.4 / 7.91
UFDMP-76	Rack w/6 drawers (7 compartments per drawer) for Microtiter Plates	25 <sup>1</sup> / <sub>4</sub> x 14 <sup>1</sup> / <sub>2</sub> x 5 <sup>7</sup> / <sub>16</sub> inch 642 x 368 x 138 mm	126 w/lids 168 w/o lids	DD-14	20.7 / 9.38

\*Lock device is ordered separately.

## Chest Freezer Racks

(Locking Rod Included)

For 96-Well & 384-Well Microtiter Plates

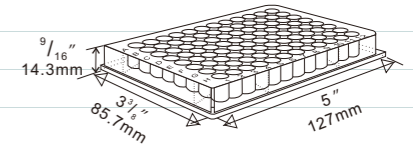

- ◆ Made of corrosion resistant stainless steel.
- ◆ Locking rods are included.
- ◆ Security lock devices are available for each rack.

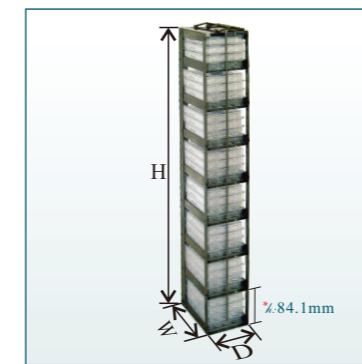

Chest Freezer Rack



Rack w/DR Lock Device Option

Part Number	Dimension H x D x W	Capacity (Plate)	Lock Device Option*	Shipping Weight (lb/Kg)
CFMP-5	16 <sup>13</sup> / <sub>16</sub> x 3 <sup>5</sup> / <sub>8</sub> x 5 <sup>1</sup> / <sub>2</sub> inch 427 x 92 x 140 mm	25 Plates w/lids	DR-15	2.0 / 0.91
		30 Plates w/o lids		
CFMP-6	20 <sup>1</sup> / <sub>8</sub> x 3 <sup>3</sup> / <sub>8</sub> x 5 <sup>1</sup> / <sub>2</sub> inch 511 x 92 x 140 mm	30 Plates w/lids	DR-19	2.3 / 1.06
		36 Plates w/o lids		
CFMP-7	23 <sup>7</sup> / <sub>16</sub> x 3 <sup>3</sup> / <sub>8</sub> x 5 <sup>1</sup> / <sub>2</sub> inch 595 x 92 x 140 mm	35 Plates w/lids	DR-22	2.7 / 1.21
		42 Plates w/o lids		
CFMP-8	26 <sup>3</sup> / <sub>4</sub> x 3 <sup>3</sup> / <sub>8</sub> x 5 <sup>1</sup> / <sub>2</sub> inch 679 x 92 x 140 mm	40 Plates w/lids	DR-25	3.0 / 1.37
		48 Plates w/o lids		
CFMP-9	30 <sup>1</sup> / <sub>16</sub> x 3 <sup>3</sup> / <sub>8</sub> x 5 <sup>1</sup> / <sub>2</sub> inch 763 x 92 x 140 mm	45 Plates w/lids	DR-29	3.4 / 1.52
		54 Plates w/o lids		

\*Lock device is ordered separately.



## Upright Freezer Racks

### For 96 Deep-Well Microtiter Plates

- ◆ Made of corrosion resistant stainless steel.
- ◆ Locking rods are included.
- ◆ Security lock devices are available for each rack.

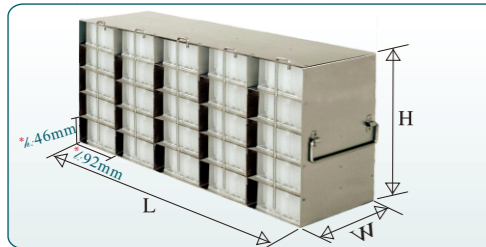
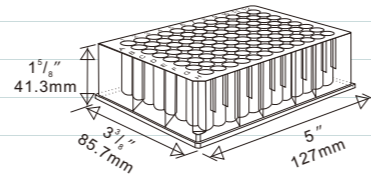

Part Number	Dimension L x H x W	Capacity (Plate)	Lock Device Option*	Shipping Weight(lb/Kg)
UFDP-34L	11 1/2 x 7 1/2 x 5 1/2 inch 292.5 x 191 x 140 mm	3 x 4 = 12	DP-1107	4.2 / 1.91
UFDP-35L	11 1/2 x 9 3/8 x 5 1/2 inch 292.5 x 237.5 x 140 mm	3 x 5 = 15	DP-1109	5.0 / 2.28
UFDP-36L	11 1/2 x 11 3/16 x 5 1/2 inch 292.5 x 283.5 x 140 mm	3 x 6 = 18	DP-1111	5.8 / 2.64
UFDP-44L	15 3/16 x 7 1/2 x 5 1/2 inch 385.3 x 191 x 140 mm	4 x 4 = 16	DP-1507	5.4 / 2.47
UFDP-45L	15 3/16 x 9 3/8 x 5 1/2 inch 385.3 x 237.5 x 140mm	4 x 5 = 20	DP-1509	6.5 / 2.95
UFDP-46L	15 3/16 x 11 3/16 x 5 1/2 inch 385.3 x 283.5 x 140 mm	4 x 6 = 24	DP-1511	7.5 / 3.42
UFDP-54L	18 13/16 x 7 1/2 x 5 1/2 inch 478 x 191 x 140 mm	5 x 4 = 20	DP-1807	6.7 / 3.03
UFDP-55L	18 13/16 x 9 3/8 x 5 1/2 inch 478 x 237 x 140 mm	5 x 5 = 25	DP-1809	8.2 / 3.72
UFDP-56L	18 13/16 x 11 3/16 x 5 1/2 inch 478 x 284 x 140mm	5 x 6 = 30	DP-1811	9.5 / 4.32
UFDP-64L	22 1/2 x 7 1/2 x 5 1/2 inch 571 x 191 x 140 mm	6 x 4 = 24	DP-2207	8.0 / 3.62
UFDP-65L	22 1/2 x 9 3/8 x 5 1/2 inch 571 x 237 x 140 mm	6 x 5 = 30	DP-2209	9.8 / 4.43
UFDP-66L	22 1/2 x 11 3/16 x 5 1/2 inch 571 x 284 x 140 mm	6 x 6 = 36	DP-2211	11.3 / 5.13
UFDP-74L	26 1/8 x 7 1/2 x 5 1/2 inch 663.7 x 191 x 140 mm	7 x 4 = 28	DP-2507	9.2 / 4.17
UFDP-75L	26 1/8 x 9 3/8 x 5 1/2 inch 663.7 x 237.5 x 140 mm	7 x 5 = 35	DP-2509	11.3 / 5.11
UFDP-76L	26 1/8 x 11 3/16 x 5 1/2 inch 663.7 x 283.5 x 140 mm	7 x 6 = 42	DP-2511	13.1 / 5.93

\*Lock device is ordered separately.

## Upright Freezer Drawer Racks

### For 96 Deep-Well Microtiter Plates

- ◆ Made of corrosion resistant stainless steel.
- ◆ Drawer racks allow easy access to fewer microtiter plates at a time thus protecting other samples in the rack from warming up.
- ◆ Security lock devices are available for each rack.

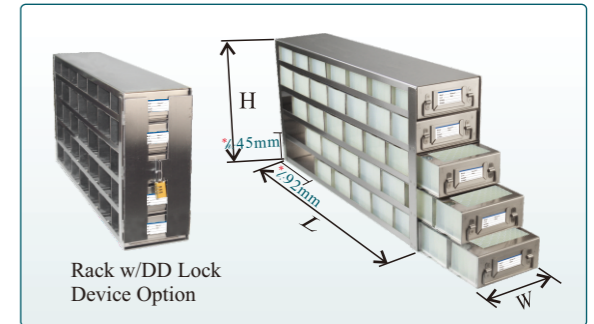
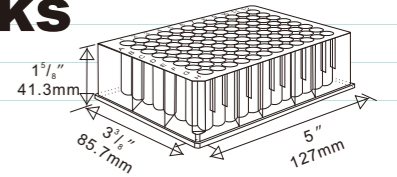

Part Number	Description	Dimension L x H x W	Capacity	Lock Device Option*	Shipping Weight(lb/Kg)
UFDDP-33	Rack w/3 drawers (3 compartments per drawer) for 96Deep Well Microtiter Plates	11 1/8 x 6 1/16 x 5 7/16 inch 282 x 154 x 138 mm	3x3=9	DD-05	5.2 / 2.38
UFDDP-34	Rack w/4 drawers (3 compartments per drawer) for 96Deep Well Microtiter Plates	11 1/8 x 8 1/16 x 5 7/16 inch 282 x 205 x 138 mm	3x4=12	DD-07	6.8 / 3.09
UFDDP-35	Rack w/5 drawers (3 compartments per drawer) for 96Deep Well Microtiter Plates	11 1/8 x 10 1/16 x 5 7/16 inch 282 x 256 x 138 mm	3x5=15	DR-10	8.4 / 3.79
UFDDP-36	Rack w/6 drawers (3 compartments per drawer) for 96Deep Well Microtiter Plates	11 1/8 x 12 1/16 x 5 7/16 inch 282 x 307 x 138 mm	3x6=18	DD-12	9.9 / 4.50
UFDDP-37	Rack w/7 drawers (3 compartments per drawer) for 96Deep Well Microtiter Plates	11 1/8 x 14 1/8 x 5 7/16 inch 282 x 358 x 138 mm	3x7=21	DD-14	11.7 / 5.30
UFDDP-43	Rack w/3 drawers (3 compartments per drawer) for 96Deep Well Microtiter Plates	14 3/8 x 6 1/16 x 5 7/16 inch 372 x 154 x 138 mm	4x3=12	DD-05	6.6 / 3.00
UFDDP-44	Rack w/4 drawers (3 compartments per drawer) for 96Deep Well Microtiter Plates	14 3/8 x 8 1/16 x 5 7/16 inch 372 x 205 x 138 mm	4x4=16	DD-07	8.6 / 3.89
UFDDP-45	Rack w/5 drawers (3 compartments per drawer) for 96Deep Well Microtiter Plates	14 3/8 x 10 1/16 x 5 7/16 inch 372 x 256 x 138 mm	4x5=20	DR-10	10.5 / 4.77
UFDDP-46	Rack w/6 drawers (3 compartments per drawer) for 96Deep Well Microtiter Plates	14 3/8 x 12 1/16 x 5 7/16 inch 372 x 307 x 138 mm	4x6=24	DD-12	12.5 / 5.66
UFDDP-47	Rack w/7 drawers (3 compartments per drawer) for 96Deep Well Microtiter Plates	14 3/8 x 14 1/8 x 5 7/16 inch 372 x 358 x 138 mm	4x7=28	DD-14	14.6 / 6.60
UFDDP-53	Rack w/3 drawers (3 compartments per drawer) for 96Deep Well Microtiter Plates	18 3/16 x 6 1/16 x 5 7/16 inch 462 x 154 x 138 mm	5x3=15	DD-05	8.0 / 3.61
UFDDP-54	Rack w/4 drawers (3 compartments per drawer) for 96Deep Well Microtiter Plates	18 3/16 x 8 1/16 x 5 7/16 inch 462 x 205 x 138 mm	5x4=20	DD-07	10.3 / 4.68
UFDDP-55	Rack w/5 drawers (3 compartments per drawer) for 96Deep Well Microtiter Plates	18 3/16 x 10 1/16 x 5 7/16 inch 462 x 256 x 138 mm	5x5=25	DR-10	12.7 / 5.75
UFDDP-56	Rack w/6 drawers (3 compartments per drawer) for 96Deep Well Microtiter Plates	18 3/16 x 12 1/16 x 5 7/16 inch 462 x 307 x 138 mm	5x6=30	DD-12	15.0 / 6.81
UFDDP-57	Rack w/7 drawers (3 compartments per drawer) for 96Deep Well Microtiter Plates	18 3/16 x 14 1/8 x 5 7/16 inch 462 x 358 x 138 mm	5x7=35	DD-14	17.4 / 7.90
UFDDP-63	Rack w/3 drawers (3 compartments per drawer) for 96Deep Well Microtiter Plates	21 3/4 x 6 1/16 x 5 7/16 inch 552 x 154 x 138 mm	6x3=18	DD-05	9.3 / 4.23
UFDDP-64	Rack w/4 drawers (3 compartments per drawer) for 96Deep Well Microtiter Plates	21 3/4 x 8 1/16 x 5 7/16 inch 552 x 205 x 138 mm	6x4=24	DD-07	12.1 / 5.48
UFDDP-65	Rack w/5 drawers (3 compartments per drawer) for 96Deep Well Microtiter Plates	21 3/4 x 10 1/16 x 5 7/16 inch 552 x 256 x 138 mm	6x5=30	DR-10	14.8 / 6.73
UFDDP-66	Rack w/6 drawers (3 compartments per drawer) for 96Deep Well Microtiter Plates	21 3/4 x 12 1/16 x 5 7/16 inch 552 x 307 x 138 mm	6x6=36	DD-12	17.6 / 7.97
UFDDP-67	Rack w/7 drawers (3 compartments per drawer) for 96Deep Well Microtiter Plates	21 3/4 x 14 1/8 x 5 7/16 inch 552 x 358 x 138 mm	6x7=42	DD-14	20.3 / 9.20
UFDDP-73	Rack w/3 drawers (3 compartments per drawer) for 96Deep Well Microtiter Plates	25 3/16 x 6 1/16 x 5 7/16 inch 640 x 154 x 138 mm	7x3=21	DD-05	10.7 / 4.84
UFDDP-74	Rack w/4 drawers (3 compartments per drawer) for 96Deep Well Microtiter Plates	25 3/16 x 8 1/16 x 5 7/16 inch 640 x 205 x 138 mm	7x4=28	DD-07	13.8 / 6.27
UFDDP-75	Rack w/5 drawers (3 compartments per drawer) for 96Deep Well Microtiter Plates	25 3/16 x 10 1/16 x 5 7/16 inch 640 x 256 x 138 mm	7x5=35	DR-10	17.0 / 7.70
UFDDP-76	Rack w/6 drawers (3 compartments per drawer) for 96Deep Well Microtiter Plates	25 3/16 x 12 1/16 x 5 7/16 inch 640 x 307 x 138 mm	7x6=42	DD-12	20.1 / 9.12
UFDDP-77	Rack w/7 drawers (3 compartments per drawer) for 96Deep Well Microtiter Plates	25 3/16 x 14 1/8 x 5 7/16 inch 640 x 358 x 138 mm	7x7=49	DD-14	24.1 / 10.63

\*Lock device is ordered separately.

# Chest Freezer Racks

(Locking Rod Included)

## For 96 Deep-Well Microtiter Plates

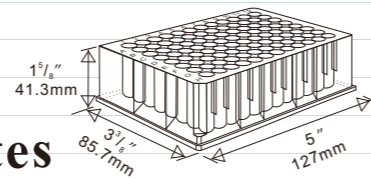

- ◆ Made of corrosion resistant stainless steel.
- ◆ Security lock devices are available for each rack.

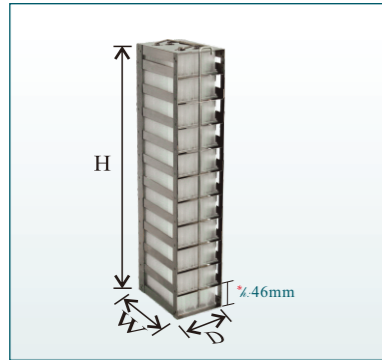

Rack w/DR Lock Device Option

Part Number	Dimension H x D x W	Capacity (Plate)	Lock Device Option*	Shipping Weight(lb/Kg)
CFDP-9	16 <sup>5</sup> / <sub>8</sub> x 3 <sup>5</sup> / <sub>8</sub> x 5 <sup>1</sup> / <sub>2</sub> inch 423 x 92 x 140mm	9	DR-15	3.1 / 1.39
CFDP-10	18 <sup>7</sup> / <sub>16</sub> x 3 <sup>5</sup> / <sub>8</sub> x 5 <sup>1</sup> / <sub>2</sub> inch 469 x 92 x 140mm	10	DR-17	3.3 / 1.48
CFDP-11	20 <sup>1</sup> / <sub>4</sub> x 3 <sup>5</sup> / <sub>8</sub> x 5 <sup>1</sup> / <sub>2</sub> inch 515 x 92 x 140mm	11	DR-19	3.5 / 1.61
CFDP-12	22 <sup>1</sup> / <sub>8</sub> x 3 <sup>5</sup> / <sub>8</sub> x 5 <sup>1</sup> / <sub>2</sub> inch 562 x 92 x 140mm	12	DR-22	3.8 / 1.73
CFDP-13	23 <sup>15</sup> / <sub>16</sub> x 3 <sup>5</sup> / <sub>8</sub> x 5 <sup>1</sup> / <sub>2</sub> inch 608 x 92 x 140mm	13	DR-23	4.1 / 1.86
CFDP-14	25 <sup>1</sup> / <sub>4</sub> x 3 <sup>5</sup> / <sub>8</sub> x 5 <sup>1</sup> / <sub>2</sub> inch 654 x 92 x 140mm	14	DR-25	4.4 / 1.99
CFDP-15	27 <sup>9</sup> / <sub>16</sub> x 3 <sup>5</sup> / <sub>8</sub> x 5 <sup>1</sup> / <sub>2</sub> inch 700 x 92 x 140mm	15	DR-27	4.7 / 2.12
CFDP-16	29 <sup>7</sup> / <sub>16</sub> x 3 <sup>5</sup> / <sub>8</sub> x 5 <sup>1</sup> / <sub>2</sub> inch 747 x 92 x 140mm	16	DR-29	5.0 / 2.25

\*Lock device is ordered separately.

# Upright Freezer Racks

## For 96-Well Microtube Boxes

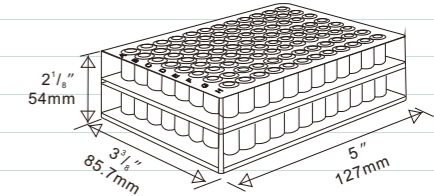

- ◆ Made of corrosion resistant stainless steel.
- ◆ Locking rods are included.
- ◆ Security lock devices are available for each rack.

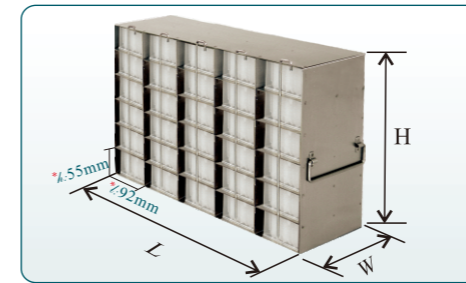

Rack w/DP Lock Device Option

Part Number	Dimension L x H x W	Capacity (Box)	Lock Device Option*	Shipping Weight(lb/Kg)
UFTB-33L	11 <sup>9</sup> / <sub>16</sub> x 6 <sup>13</sup> / <sub>16</sub> x 5 <sup>1</sup> / <sub>2</sub> inch 293 x 173 x 140mm	3 x 3 = 9	DP-1107	3.7 / 1.70
UFTB-34L	11 <sup>1</sup> / <sub>16</sub> x 9 x 5 <sup>1</sup> / <sub>2</sub> inch 293 x 228 x 140mm	3 x 4 = 12	DP-1109	4.7 / 2.12
UFTB-35L	11 <sup>9</sup> / <sub>16</sub> x 11 <sup>1</sup> / <sub>16</sub> x 5 <sup>1</sup> / <sub>2</sub> inch 293 x 284 x 140mm	3 x 5 = 15	DP-1111	5.6 / 2.53
UFTB-36L	11 <sup>9</sup> / <sub>16</sub> x 13 <sup>3</sup> / <sub>8</sub> x 5 <sup>1</sup> / <sub>2</sub> inch 293 x 339 x 140mm	3 x 6 = 18	DP-1113	6.5 / 2.95
UFTB-43L	15 <sup>3</sup> / <sub>16</sub> x 6 <sup>13</sup> / <sub>16</sub> x 5 <sup>1</sup> / <sub>2</sub> inch 385 x 173 x 140mm	4 x 3 = 12	DP-1407	4.9 / 2.20
UFTB-44L	15 <sup>3</sup> / <sub>16</sub> x 9 x 5 <sup>1</sup> / <sub>2</sub> inch 385 x 228 x 140mm	4 x 4 = 16	DP-1409	6.0 / 2.74
UFTB-45L	15 <sup>3</sup> / <sub>16</sub> x 11 <sup>1</sup> / <sub>16</sub> x 5 <sup>1</sup> / <sub>2</sub> inch 385 x 284 x 140mm	4 x 5 = 20	DP-1411	7.2 / 3.27
UFTB-46L	15 <sup>3</sup> / <sub>16</sub> x 13 <sup>3</sup> / <sub>8</sub> x 5 <sup>1</sup> / <sub>2</sub> inch 385 x 339 x 140mm	4 x 6 = 24	DP-1413	8.4 / 3.81
UFTB-53L	18 <sup>13</sup> / <sub>16</sub> x 6 <sup>13</sup> / <sub>16</sub> x 5 <sup>1</sup> / <sub>2</sub> inch 478 x 173 x 140mm	5 x 3 = 15	DP-1807	5.9 / 2.69
UFTB-54L	18 <sup>13</sup> / <sub>16</sub> x 9 x 5 <sup>1</sup> / <sub>2</sub> inch 478 x 228 x 140mm	5 x 4 = 20	DP-1809	7.4 / 3.36
UFTB-55L	18 <sup>13</sup> / <sub>16</sub> x 11 <sup>1</sup> / <sub>16</sub> x 5 <sup>1</sup> / <sub>2</sub> inch 478 x 284 x 140mm	5 x 5 = 25	DP-1811	8.9 / 4.02
UFTB-56L	18 <sup>13</sup> / <sub>16</sub> x 13 <sup>3</sup> / <sub>8</sub> x 5 <sup>1</sup> / <sub>2</sub> inch 478 x 339 x 140mm	5 x 6 = 30	DP-1813	10.3 / 4.68
UFTB-63L	22 <sup>1</sup> / <sub>2</sub> x 6 <sup>13</sup> / <sub>16</sub> x 5 <sup>1</sup> / <sub>2</sub> inch 571 x 173 x 140mm	6 x 3 = 18	DP-2207	7.0 / 3.17
UFTB-64L	22 <sup>1</sup> / <sub>2</sub> x 9 x 5 <sup>1</sup> / <sub>2</sub> inch 571 x 228 x 140mm	6 x 4 = 24	DP-2209	8.8 / 3.97
UFTB-65L	22 <sup>1</sup> / <sub>2</sub> x 11 <sup>1</sup> / <sub>16</sub> x 5 <sup>1</sup> / <sub>2</sub> inch 571 x 284 x 140mm	6 x 5 = 30	DP-2211	10.5 / 4.76
UFTB-66L	22 <sup>1</sup> / <sub>2</sub> x 13 <sup>3</sup> / <sub>8</sub> x 5 <sup>1</sup> / <sub>2</sub> inch 571 x 339 x 140mm	6 x 6 = 36	DP-2213	12.2 / 5.54
UFTB-73L	26 <sup>1</sup> / <sub>8</sub> x 6 <sup>13</sup> / <sub>16</sub> x 5 <sup>1</sup> / <sub>2</sub> inch 664 x 173 x 140mm	7 x 3 = 21	DP-2607	8.1 / 3.68
UFTB-74L	26 <sup>1</sup> / <sub>8</sub> x 9 x 5 <sup>1</sup> / <sub>2</sub> inch 664 x 228 x 140mm	7 x 4 = 28	DP-2609	10.1 / 4.59
UFTB-75L	26 <sup>1</sup> / <sub>8</sub> x 11 <sup>1</sup> / <sub>16</sub> x 5 <sup>1</sup> / <sub>2</sub> inch 664 x 284 x 140mm	7 x 5 = 35	DP-2611	11.9 / 5.42
UFTB-76L	26 <sup>1</sup> / <sub>8</sub> x 13 <sup>3</sup> / <sub>8</sub> x 5 <sup>1</sup> / <sub>2</sub> inch 664 x 339 x 140mm	7 x 6 = 42	DP-2613	14.2 / 6.42

\*Lock device is ordered separately.

## Upright Freezer Drawer Racks

### For 96-Well Microtube Boxes

- ◆ Made of corrosion resistant stainless steel.
- ◆ Drawer racks allow easy access to fewer microtiter plates at a time thus protecting other samples in the rack from warming up.
- ◆ Security lock devices are available for each rack.

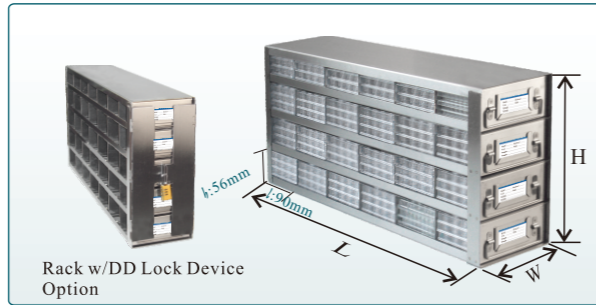
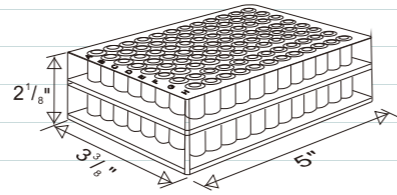

Part Number	Description	Dimension L x H x W	Capacity (Microtube Boxes)	Lock Device Option*	Shipping Weight(lb/Kg)
UFDMP-33	Rack w/3 drawers (3 compartments per drawer) for Microtube boxes	11 1/8 x 7 7/16 x 5 7/16 inch 282 x 186 x 138 mm	9	DD-06	5.4 / 2.45
UFDMP-34	Rack w/4 drawers (3 compartments per drawer) for Microtube boxes	11 1/8 x 9 3/4 x 5 7/16 inch 282 x 247 x 138 mm	12	DD-09	6.9 / 3.13
UFDMP-35	Rack w/5 drawers (3 compartments per drawer) for Microtube boxes	11 1/8 x 12 1/8 x 5 7/16 inch 282 x 308 x 138mm	15	DD-11	8.6 / 3.90
UFDMP-36	Rack w/6 drawers (3 compartments per drawer) for Microtube boxes	11 1/8 x 14 1/2 x 5 7/16 inch 282 x 369 x 138mm	18	DD-14	10.2 / 4.64
UFDMP-43	Rack w/3 drawers (4 compartments per drawer) for Microtube boxes	14 3/8 x 7 7/16 x 5 7/16 inch 372 x 186 x 138 mm	12	DD-06	6.8 / 3.10
UFDMP-44	Rack w/4 drawers (4 compartments per drawer) for Microtube boxes	14 3/8 x 9 3/4 x 5 7/16 inch 372 x 247 x 138 mm	16	DD-09	8.9 / 4.02
UFDMP-45	Rack w/5 drawers (4 compartments per drawer) for Microtube boxes	14 3/8 x 12 1/8 x 5 7/16 inch 372 x 308 x 138mm	20	DD-11	10.9 / 4.94
UFDMP-46	Rack w/6 drawers (4 compartments per drawer) for Microtube boxes	14 3/8 x 14 1/2 x 5 7/16 inch 372 x 369 x 138mm	24	DD-14	10.7 / 5.86
UFDMP-53	Rack w/3 drawers (5 compartments per drawer) for Microtube boxes	18 3/16 x 7 7/16 x 5 7/16 inch 462 x 186 x 138 mm	15	DD-06	8.2 / 3.70
UFDMP-54	Rack w/4 drawers (5 compartments per drawer) for Microtube boxes	18 3/16 x 9 3/4 x 5 7/16 inch 462 x 247 x 138 mm	20	DD-09	10.6 / 4.79
UFDMP-55	Rack w/5 drawers (5 compartments per drawer) for Microtube boxes	18 3/16 x 12 1/8 x 5 7/16 inch 462 x 308 x 138mm	25	DD-11	13.0 / 5.90
UFDMP-56	Rack w/6 drawers (5 compartments per drawer) for Microtube boxes	18 3/16 x 14 1/2 x 5 7/16 inch 462 x 369 x 138mm	30	DD-14	15.4 / 7.00
UFDMP-63	Rack w/3 drawers (6 compartments per drawer) for Microtube boxes	21 3/4 x 7 7/16 x 5 7/16 inch 552 x 186 x 138 mm	18	DD-06	9.7 / 4.42
UFDMP-64	Rack w/4 drawers (6 compartments per drawer) for Microtube boxes	21 3/4 x 9 3/4 x 5 7/16 inch 552 x 247 x 138 mm	24	DD-09	12.6 / 5.73
UFDMP-65	Rack w/5 drawers (6 compartments per drawer) for Microtube boxes	21 3/4 x 12 1/8 x 5 7/16 inch 552 x 308 x 138mm	30	DD-11	15.5 / 7.05
UFDMP-66	Rack w/6 drawers (6 compartments per drawer) for Microtube boxes	21 3/4 x 14 1/2 x 5 7/16 inch 552 x 369 x 138mm	36	DD-14	17.9 / 8.14
UFDMP-73	Rack w/3 drawers (7 compartments per drawer) for Microtube boxes	25 1/4 x 7 7/16 x 5 7/16 inch 642 x 186 x 138 mm	21	DD-06	11.0 / 4.97
UFDMP-74	Rack w/4 drawers (7 compartments per drawer) for Microtube boxes	25 1/4 x 9 3/4 x 5 7/16 inch 642 x 247 x 138 mm	28	DD-09	14.2 / 6.43
UFDMP-75	Rack w/5 drawers (7 compartments per drawer) for Microtube boxes	25 1/4 x 12 1/8 x 5 7/16 inch 642 x 308 x 138mm	35	DD-11	17.4 / 7.91
UFDMP-76	Rack w/6 drawers (7 compartments per drawer) for Microtube boxes	25 1/4 x 14 1/2 x 5 7/16 inch 642 x 369 x 138mm	42	DD-14	20.7 / 9.38

\*Lock device is ordered separately.

## Chest Freezer Racks

### For 96-Well Microtube Boxes

- ◆ Made of corrosion resistant stainless steel.
- ◆ Locking rods are included.
- ◆ Security lock devices are available for each rack.

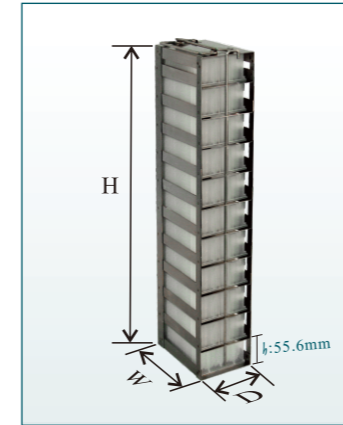
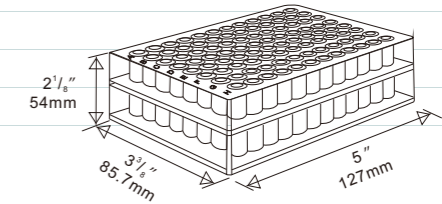

Part Number	Dimension H x D x W	Capacity (Box)	Lock Device Option*	Shipping Weight(lb/Kg)
CFTB-8	17 7/16 x 3 5/8 x 5 1/2 inch 455 x 92 x 140 mm	8	DR-17	2.8 / 1.27
CFTB-9	20 3/16 x 3 5/8 x 5 1/2 inch 512 x 92 x 140 mm	9	DR-19	3.1 / 1.41
CFTB-10	22 7/8 x 3 5/8 x 5 1/2 inch 568 x 92 x 140mm	10	DR-22	3.4 / 1.55
CFTB-11	24 9/16 x 3 5/8 x 5 1/2 inch 624 x 92 x 140 mm	11	DR-23	3.7 / 1.68
CFTB-12	26 3/4 x 3 5/8 x 5 1/2 inch 680 x 92 x 140 mm	12	DR-26	4.0 / 1.82
CFTB-13	29 x 3 5/8 x 5 1/2 inch 736 x 92 x 140mm	13	DR-29	4.3 / 1.96

\*Lock device is ordered separately.

## Upright Freezer Rack

(Locking Rod Included)

### For 50-Cell Hinged Top Plastic Boxes

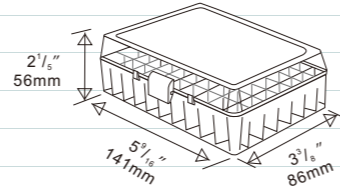

- Made of corrosion resistant stainless steel.

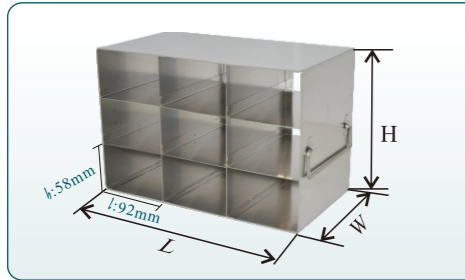

Part Number	Dimension L x H x W	Capacity (Box)	Shipping Weight(lb/Kg)
UFH50-33	11 <sup>1</sup> / <sub>2</sub> x 7 <sup>1</sup> / <sub>2</sub> x 5 <sup>7</sup> / <sub>8</sub> inch 292 x 184 x 150 mm	3 x 3 = 9	3.9 / 1.79
UFH50-34	11 <sup>1</sup> / <sub>2</sub> x 9 <sup>1</sup> / <sub>2</sub> x 5 <sup>7</sup> / <sub>8</sub> inch 292 x 242 x 150 mm	3 x 4 = 12	4.9 / 2.23
UFH50-35	11 <sup>1</sup> / <sub>2</sub> x 11 <sup>7</sup> / <sub>8</sub> x 5 <sup>7</sup> / <sub>8</sub> inch 292 x 301 x 150 mm	3 x 5 = 15	5.9 / 2.68
UFH50-36	11 <sup>1</sup> / <sub>2</sub> x 14 <sup>1</sup> / <sub>8</sub> x 5 <sup>7</sup> / <sub>8</sub> inch 292 x 359 x 150 mm	3 x 6 = 18	6.9 / 3.12
UFH50-43	15 <sup>3</sup> / <sub>16</sub> x 7 <sup>1</sup> / <sub>4</sub> x 5 <sup>7</sup> / <sub>8</sub> inch 385 x 184 x 150 mm	4 x 3 = 12	5.1 / 2.31
UFH50-44	15 <sup>3</sup> / <sub>16</sub> x 9 <sup>1</sup> / <sub>2</sub> x 5 <sup>7</sup> / <sub>8</sub> inch 385 x 242 x 150 mm	4 x 4 = 16	6.3 / 2.88
UFH50-45	15 <sup>3</sup> / <sub>16</sub> x 11 <sup>7</sup> / <sub>8</sub> x 5 <sup>1</sup> / <sub>2</sub> inch 385 x 301 x 150 mm	4 x 5 = 20	7.6 / 3.46
UFH50-46	15 <sup>3</sup> / <sub>16</sub> x 14 <sup>1</sup> / <sub>8</sub> x 5 <sup>7</sup> / <sub>8</sub> inch 385 x 359 x 150 mm	4 x 6 = 24	8.9 / 4.03
UFH50-53	18 <sup>13</sup> / <sub>16</sub> x 7 <sup>1</sup> / <sub>4</sub> x 5 <sup>7</sup> / <sub>8</sub> inch 478 x 184 x 150 mm	5 x 3 = 15	6.5 / 2.93
UFH50-54	18 <sup>13</sup> / <sub>16</sub> x 9 <sup>1</sup> / <sub>2</sub> x 5 <sup>7</sup> / <sub>8</sub> inch 478 x 242 x 150 mm	5 x 4 = 20	8.1 / 3.66
UFH50-55	18 <sup>13</sup> / <sub>16</sub> x 11 <sup>7</sup> / <sub>8</sub> x 5 <sup>7</sup> / <sub>8</sub> inch 478 x 301 x 150 mm	5 x 5 = 25	9.6 / 4.35
UFH50-56	18 <sup>13</sup> / <sub>16</sub> x 14 <sup>1</sup> / <sub>8</sub> x 5 <sup>7</sup> / <sub>8</sub> inch 478 x 359 x 150 mm	5 x 6 = 30	11.2 / 5.08
UFH50-63	24 <sup>1</sup> / <sub>16</sub> x 7 <sup>1</sup> / <sub>4</sub> x 5 <sup>7</sup> / <sub>8</sub> inch 611 x 184 x 150 mm	6 x 3 = 18	7.6 / 3.43
UFH50-64	24 <sup>1</sup> / <sub>16</sub> x 9 <sup>1</sup> / <sub>2</sub> x 5 <sup>7</sup> / <sub>8</sub> inch 611 x 242 x 150 mm	6 x 4 = 24	9.5 / 4.29
UFH50-65	24 <sup>1</sup> / <sub>16</sub> x 11 <sup>7</sup> / <sub>8</sub> x 5 <sup>7</sup> / <sub>8</sub> inch 611 x 301 x 150 mm	6 x 5 = 30	11.4 / 5.15
UFH50-66	24 <sup>1</sup> / <sub>16</sub> x 14 <sup>1</sup> / <sub>8</sub> x 5 <sup>7</sup> / <sub>8</sub> inch 611 x 359 x 150 mm	6 x 6 = 36	13.2 / 6.01
UFH50-73	26 <sup>1</sup> / <sub>8</sub> x 7 <sup>1</sup> / <sub>4</sub> x 5 <sup>7</sup> / <sub>8</sub> inch 664 x 184 x 150 mm	7 x 3 = 21	8.8 / 3.97
UFH50-74	26 <sup>1</sup> / <sub>8</sub> x 9 <sup>1</sup> / <sub>2</sub> x 5 <sup>7</sup> / <sub>8</sub> inch 664 x 242 x 150 mm	7 x 4 = 28	10.9 / 4.96
UFH50-75	26 <sup>1</sup> / <sub>8</sub> x 11 <sup>7</sup> / <sub>8</sub> x 5 <sup>7</sup> / <sub>8</sub> inch 664 x 301 x 150 mm	7 x 5 = 35	13.1 / 5.95
UFH50-76	26 <sup>1</sup> / <sub>8</sub> x 14 <sup>1</sup> / <sub>8</sub> x 5 <sup>7</sup> / <sub>8</sub> inch 664 x 359 x 150 mm	7 x 6 = 42	15.3 / 6.94

## Upright Freezer Drawer Rack

### For 50-Cell Hinged Top Plastic Boxes

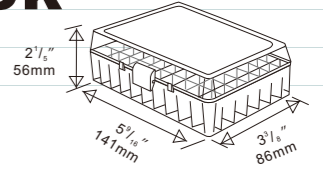

- Made of corrosion resistant stainless steel.
- Drawer racks allow easy access to and storage of samples without having to remove the whole racks from the freezer.
- Security lock devices are available for each rack.

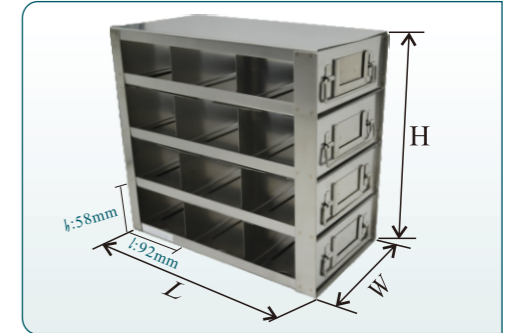

Part Number	Dimension L x H x W	Capacity (Box)	Shipping Weight(lb/Kg)
UFDH50-33	10 <sup>15</sup> / <sub>16</sub> x 7 <sup>1</sup> / <sub>8</sub> x 5 <sup>7</sup> / <sub>8</sub> inch 278 x 193 x 150 mm	3 x 3 = 9	5.7 / 2.57
UFDH50-34	10 <sup>15</sup> / <sub>16</sub> x 10 <sup>1</sup> / <sub>16</sub> x 5 <sup>7</sup> / <sub>8</sub> inch 278 x 256 x 150 mm	3 x 4 = 12	7.3 / 3.33
UFDH50-35	10 <sup>15</sup> / <sub>16</sub> x 12 <sup>5</sup> / <sub>8</sub> x 5 <sup>7</sup> / <sub>8</sub> inch 278 x 320 x 150 mm	3 x 5 = 15	9.0 / 4.09
UFDH50-36	10 <sup>15</sup> / <sub>16</sub> x 15 <sup>1</sup> / <sub>16</sub> x 5 <sup>7</sup> / <sub>8</sub> inch 278 x 383 x 150 mm	3 x 6 = 18	10.7 / 4.85
UFDH50-43	14 <sup>7</sup> / <sub>16</sub> x 7 <sup>1</sup> / <sub>8</sub> x 5 <sup>7</sup> / <sub>8</sub> inch 367 x 193 x 150 mm	4 x 3 = 12	7.1 / 3.23
UFDH50-44	14 <sup>7</sup> / <sub>16</sub> x 10 <sup>1</sup> / <sub>16</sub> x 5 <sup>7</sup> / <sub>8</sub> inch 367 x 256 x 150 mm	4 x 4 = 16	9.2 / 4.19
UFDH50-45	14 <sup>7</sup> / <sub>16</sub> x 12 <sup>5</sup> / <sub>8</sub> x 5 <sup>7</sup> / <sub>8</sub> inch 367 x 320 x 150 mm	4 x 5 = 20	11.3 / 5.14
UFDH50-46	14 <sup>7</sup> / <sub>16</sub> x 14 <sup>1</sup> / <sub>8</sub> x 5 <sup>7</sup> / <sub>8</sub> inch 367 x 383 x 150 mm	4 x 6 = 24	13.4 / 6.10
UFDH50-53	17 <sup>15</sup> / <sub>16</sub> x 7 <sup>1</sup> / <sub>8</sub> x 5 <sup>7</sup> / <sub>8</sub> inch 456 x 193 x 150 mm	5 x 3 = 15	5.6 / 3.89
UFDH50-54	17 <sup>15</sup> / <sub>16</sub> x 10 <sup>1</sup> / <sub>16</sub> x 5 <sup>7</sup> / <sub>8</sub> inch 456 x 256 x 150 mm	5 x 4 = 20	11.1 / 5.04
UFDH50-55	17 <sup>15</sup> / <sub>16</sub> x 12 <sup>5</sup> / <sub>8</sub> x 5 <sup>7</sup> / <sub>8</sub> inch 456 x 320 x 150 mm	5 x 5 = 25	13.7 / 6.20
UFDH50-56	17 <sup>15</sup> / <sub>16</sub> x 15 <sup>1</sup> / <sub>16</sub> x 5 <sup>7</sup> / <sub>8</sub> inch 456 x 383 x 150 mm	5 x 6 = 30	16.2 / 7.35
UFDH50-63	21 <sup>7</sup> / <sub>16</sub> x 7 <sup>1</sup> / <sub>8</sub> x 5 <sup>7</sup> / <sub>8</sub> inch 545 x 193 x 150 mm	6 x 3 = 18	10.1 / 4.56
UFDH50-64	21 <sup>7</sup> / <sub>16</sub> x 10 <sup>1</sup> / <sub>16</sub> x 5 <sup>7</sup> / <sub>8</sub> inch 545 x 256 x 150 mm	6 x 4 = 24	13.0 / 5.91
UFDH50-65	21 <sup>7</sup> / <sub>16</sub> x 12 <sup>5</sup> / <sub>8</sub> x 5 <sup>7</sup> / <sub>8</sub> inch 545 x 320 x 150 mm	6 x 5 = 30	16.0 / 7.25
UFDH50-66	21 <sup>7</sup> / <sub>16</sub> x 15 <sup>1</sup> / <sub>16</sub> x 5 <sup>7</sup> / <sub>8</sub> inch 545 x 383 x 150 mm	6 x 6 = 36	19.0 / 8.60
UFDH50-73	24 <sup>15</sup> / <sub>16</sub> x 7 <sup>1</sup> / <sub>8</sub> x 5 <sup>7</sup> / <sub>8</sub> inch 634 x 193 x 150 mm	7 x 3 = 21	12.0 / 5.43
UFDH50-74	24 <sup>15</sup> / <sub>16</sub> x 10 <sup>1</sup> / <sub>16</sub> x 5 <sup>7</sup> / <sub>8</sub> inch 634 x 256 x 150 mm	7 x 4 = 28	14.9 / 6.76
UFDH50-75	24 <sup>15</sup> / <sub>16</sub> x 12 <sup>5</sup> / <sub>8</sub> x 5 <sup>7</sup> / <sub>8</sub> inch 634 x 320 x 150 mm	7 x 5 = 35	18.3 / 8.31
UFDH50-76	24 <sup>15</sup> / <sub>16</sub> x 15 <sup>1</sup> / <sub>16</sub> x 5 <sup>7</sup> / <sub>8</sub> inch 634 x 383 x 150 mm	7 x 6 = 42	21.3 / 9.64

## Vertical Rack

(Locking Rod Included)

### For 50-Cell Hinged Top Plastic Boxes

- Made of corrosion resistant stainless steel.

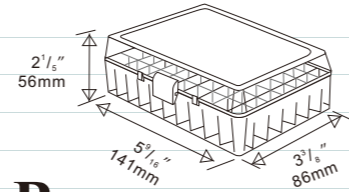
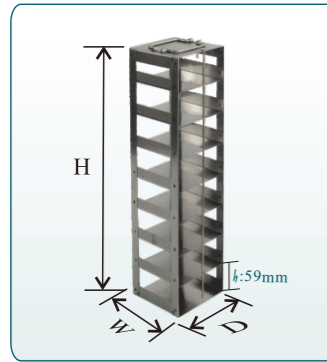

## Upright Freezer Racks

### For 100-Cell Hinged Top Plastic Storage Boxes

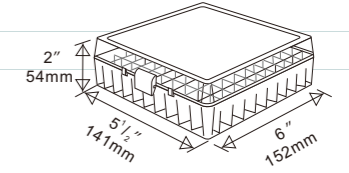

[ Check page 110 for Boxes ]

- Made of corrosion resistant stainless steel.
- Security lock devices are available for each rack.

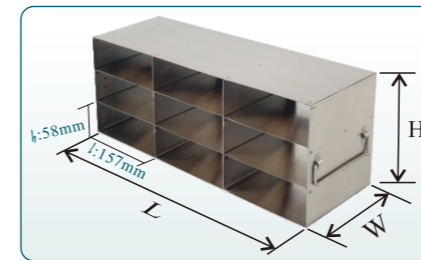

Rack Only

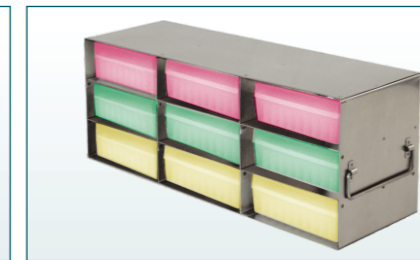

Rack w/100-Cell Hinged Plastic Storage Box

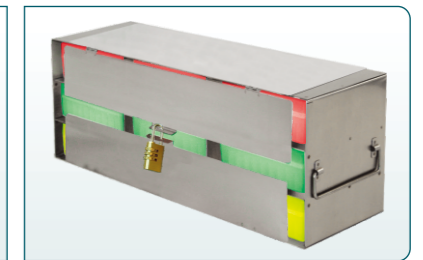

Rack w/DP Lock Device Option

Part Number	Dimension H x D x W	Capacity (Racks)	Shipping Weight(lb/Kg)
CFH50-8	18 <sup>7</sup> / <sub>8</sub> x 5 <sup>7</sup> / <sub>8</sub> x 3 <sup>3</sup> / <sub>8</sub> inch 480 x 150 x 92 mm	8	1.5 / 0.68
CFH50-9	21 <sup>1</sup> / <sub>4</sub> x 5 <sup>7</sup> / <sub>8</sub> x 3 <sup>3</sup> / <sub>8</sub> inch 539 x 150 x 92 mm	9	1.8 / 0.81
CFH50-10	23 <sup>9</sup> / <sub>16</sub> x 5 <sup>7</sup> / <sub>8</sub> x 3 <sup>3</sup> / <sub>8</sub> inch 598 x 150 x 92 mm	10	2.1 / 0.93
CFH50-11	25 <sup>5</sup> / <sub>8</sub> x 5 <sup>7</sup> / <sub>8</sub> x 3 <sup>3</sup> / <sub>8</sub> inch 657 x 150 x 92 mm	11	2.3 / 1.05
CFH50-12	28 <sup>3</sup> / <sub>16</sub> x 5 <sup>7</sup> / <sub>8</sub> x 3 <sup>3</sup> / <sub>8</sub> inch 716 x 150 x 92 mm	12	2.6 / 1.18
CFH50-13	30 <sup>1</sup> / <sub>2</sub> x 5 <sup>7</sup> / <sub>8</sub> x 3 <sup>3</sup> / <sub>8</sub> inch 775 x 150 x 92 mm	13	2.9 / 1.31

Part Number	Description	Dimension L x H x W	Capacity (Box)	Lock Device Option**	Shipping Weight lb(Kg)
UFHT-23	Rack Only	13 x 6 <sup>15</sup> / <sub>16</sub> x 5 <sup>7</sup> / <sub>8</sub> inch	2 x 3 = 6	DP-1307	3.8(1.71)
UFHT-23-PX*	Rack w/100-Cell Hinged Plastic Storage Box	330 x 176 x 149 mm			3.8(1.71)+6*ω <sup>1</sup>
UFHT-24	Rack Only	13 x 9 <sup>1</sup> / <sub>4</sub> x 5 <sup>7</sup> / <sub>8</sub> inch	2 x 4 = 8	DP-1309	4.7(2.12)
UFHT-24-PX*	Rack w/100-Cell Hinged Plastic Storage Box	330 x 235 x 149 mm			4.7(2.12)+8*ω <sup>1</sup>
UFHT-25	Rack Only	13 x 11 <sup>9</sup> / <sub>16</sub> x 5 <sup>7</sup> / <sub>8</sub> inch	2 x 5 = 10	DP-1312	5.6(2.52)
UFHT-25-PX*	Rack w/100-Cell Hinged Plastic Storage Box	330 x 293 x 149 mm			5.6(2.52)+10*ω <sup>1</sup>
UFHT-26	Rack Only	13 x 13 <sup>13</sup> / <sub>16</sub> x 5 <sup>7</sup> / <sub>8</sub> inch	2 x 6 = 12	DP-1313	6.5(2.95)
UFHT-26-PX*	Rack w/100-Cell Hinged Plastic Storage Box	330 x 351 x 149 mm			6.5(2.95)+12*ω <sup>1</sup>
UFHT-33	Rack Only	19 <sup>3</sup> / <sub>16</sub> x 6 <sup>15</sup> / <sub>16</sub> x 5 <sup>7</sup> / <sub>8</sub> inch	3 x 3 = 9	DP-1907	5.4(2.45)
UFHT-33-PX*	Rack w/100-Cell Hinged Plastic Storage Box	488 x 176 x 149 mm			5.4(2.45)+9*ω <sup>1</sup>
UFHT-34	Rack Only	19 <sup>3</sup> / <sub>16</sub> x 9 <sup>1</sup> / <sub>4</sub> x 5 <sup>7</sup> / <sub>8</sub> inch	3 x 4 = 12	DP-1909	6.7(3.02)
UFHT-34-PX*	Rack w/100-Cell Hinged Plastic Storage Box	488 x 235 x 149 mm			6.7(3.02)+12*ω <sup>1</sup>
UFHT-35	Rack Only	19 <sup>9</sup> / <sub>16</sub> x 11 <sup>9</sup> / <sub>16</sub> x 5 <sup>7</sup> / <sub>8</sub> inch	3 x 5 = 15	DP-1912	8.0(3.63)
UFHT-35-PX*	Rack w/100-Cell Hinged Plastic Storage Box	488 x 293 x 149 mm			8.0(3.63)+15*ω <sup>1</sup>
UFHT-36	Rack Only	19 <sup>3</sup> / <sub>16</sub> x 13 <sup>13</sup> / <sub>16</sub> x 5 <sup>7</sup> / <sub>8</sub> inch	3 x 6 = 18	DP-1913	9.3(4.24)
UFHT-36-PX*	Rack w/100-Cell Hinged Plastic Storage Box	488 x 351 x 149 mm			9.3(4.24)+18*ω <sup>1</sup>
UFHT-43	Rack Only	25 <sup>7</sup> / <sub>16</sub> x 6 <sup>15</sup> / <sub>16</sub> x 5 <sup>7</sup> / <sub>8</sub> inch	4 x 3 = 12	DP-2407	7.0(3.18)
UFHT-43-PX*	Rack w/100-Cell Hinged Plastic Storage Box	646 x 177 x 149 mm			7.0(3.18)+12*ω <sup>1</sup>
UFHT-44	Rack Only	25 <sup>7</sup> / <sub>16</sub> x 9 <sup>1</sup> / <sub>4</sub> x 5 <sup>7</sup> / <sub>8</sub> inch	4 x 4 = 16	DP-2409	8.7(3.93)
UFHT-44-PX*	Rack w/100-Cell Hinged Plastic Storage Box	646 x 235 x 149 mm			8.7(3.93)+16*ω <sup>1</sup>
UFHT-45	Rack Only	25 <sup>7</sup> / <sub>16</sub> x 11 <sup>9</sup> / <sub>16</sub> x 5 <sup>7</sup> / <sub>8</sub> inch	4 x 5 = 20	DP-2412	10.5(4.75)
UFHT-45-PX*	Rack w/100-Cell Hinged Plastic Storage Box	646 x 293 x 149 mm			10.5(4.75)+20*ω <sup>1</sup>
UFHT-46	Rack Only	25 <sup>7</sup> / <sub>16</sub> x 13 <sup>13</sup> / <sub>16</sub> x 5 <sup>7</sup> / <sub>8</sub> inch	4 x 6 = 24	DP-2413	12.2(5.54)
UFHT-46-PX*	Rack w/100-Cell Hinged Plastic Storage Box	646 x 351 x 149 mm			12.2(5.54)+24*ω <sup>1</sup>

\* To order replace, X with color of box: O-orange, P-pink, Y-yellow, B-blue, G-green or N-natural.

\*\* ω<sup>1</sup> = 0.41lb (0.18kg) for plastic box.

## Upright Freezer Drawer Racks

### For 100 Cell Hinged Lid Storage Boxes

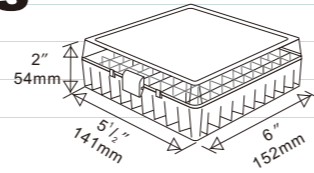

[ Check page 110 for Boxes ]

- ◆ Made of corrosion resistant stainless steel.
- ◆ Drawer racks allow easy access to and storage of samples without having to remove the whole rack from the freezer.
- ◆ Security lock devices are available for each rack.

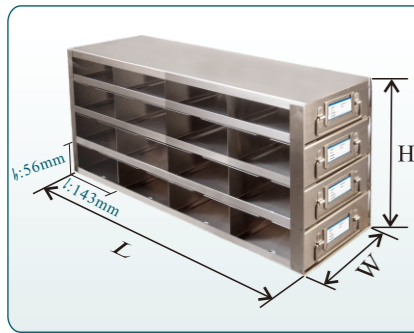

Rack Only

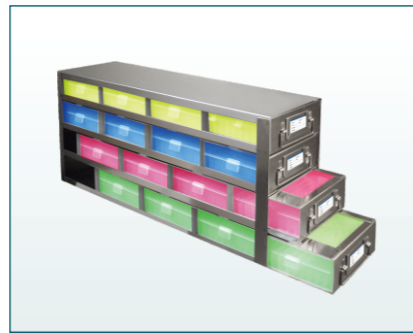

Rack w/100-Cell Hinged Plastic Storage Box



Rack w/DDHT Lock Device Option

Part Number	Description	Dimension L x H x W	Capacity (Box)	Lock Device Option**	Shipping Weight lb(Kg)
UFDHT-23	Rack Only	11 <sup>3</sup> / <sub>4</sub> x 7 <sup>7</sup> / <sub>16</sub> x 6 <sup>7</sup> / <sub>16</sub> inch	6	DDHT-06	5.9(2.67)
UFDHT-23-PX*	Rack w/100-Cell Hinged Plastic Storage Box	299 x 186 x 164 mm			5.9(2.67)+6*ω <sup>1</sup>
UFDHT-24	Rack Only	11 <sup>3</sup> / <sub>4</sub> x 9 <sup>3</sup> / <sub>4</sub> x 6 <sup>7</sup> / <sub>16</sub> inch	8	DDHT-09	7.6(3.46)
UFDHT-24-PX*	Rack w/100-Cell Hinged Plastic Storage Box	299 x 247 x 164 mm			7.6(3.46)+8*ω <sup>1</sup>
UFDHT-25	Rack Only	11 <sup>3</sup> / <sub>4</sub> x 12 <sup>1</sup> / <sub>8</sub> x 6 <sup>7</sup> / <sub>16</sub> inch	10	DDHT-11	9.5(4.29)
UFDHT-25-PX*	Rack w/100-Cell Hinged Plastic Storage Box	299 x 308 x 164 mm			9.5(4.29)+10*ω <sup>1</sup>
UFDHT-26	Rack Only	11 <sup>3</sup> / <sub>4</sub> x 14 <sup>1</sup> / <sub>2</sub> x 6 <sup>7</sup> / <sub>16</sub> inch	12	DDHT-14	11.1(5.04)
UFDHT-26-PX*	Rack w/100-Cell Hinged Plastic Storage Box	299 x 369 x 164 mm			11.1(5.04)+12*ω <sup>1</sup>
UFDHT-33	Rack Only	17 <sup>7</sup> / <sub>8</sub> x 7 <sup>7</sup> / <sub>16</sub> x 6 <sup>7</sup> / <sub>16</sub> inch	9	DDHT-06	8.0(3.62)
UFDHT-33-PX*	Rack w/100-Cell Hinged Plastic Storage Box	442 x 186 x 164 mm			8.0(3.62)+9*ω <sup>1</sup>
UFDHT-34	Rack Only	17 <sup>7</sup> / <sub>8</sub> x 9 <sup>3</sup> / <sub>4</sub> x 6 <sup>7</sup> / <sub>16</sub> inch	12	DDHT-09	10.3(4.66)
UFDHT-34-PX*	Rack w/100-Cell Hinged Plastic Storage Box	442 x 247 x 164 mm			10.3(4.66)+12*ω <sup>1</sup>
UFDHT-35	Rack Only	17 <sup>7</sup> / <sub>8</sub> x 12 <sup>1</sup> / <sub>8</sub> x 6 <sup>7</sup> / <sub>16</sub> inch	15	DDHT-11	12.6(5.72)
UFDHT-35-PX*	Rack w/100-Cell Hinged Plastic Storage Box	442 x 308 x 164 mm			12.6(5.72)+15*ω <sup>1</sup>
UFDHT-36	Rack Only	17 <sup>7</sup> / <sub>8</sub> x 14 <sup>1</sup> / <sub>2</sub> x 6 <sup>7</sup> / <sub>16</sub> inch	18	DDHT-14	14.9(6.77)
UFDHT-36-PX*	Rack w/100-Cell Hinged Plastic Storage Box	442 x 369 x 164 mm			14.9(6.77)+18*ω <sup>1</sup>
UFDHT-43	Rack Only	23 <sup>1</sup> / <sub>16</sub> x 7 <sup>5</sup> / <sub>16</sub> x 6 <sup>7</sup> / <sub>16</sub> inch	12	DDHT-06	10.2(4.62)
UFDHT-43-PX*	Rack w/100-Cell Hinged Plastic Storage Box	585 x 186 x 164 mm			10.2(4.62)+12*ω <sup>1</sup>
UFDHT-44	Rack Only	23 <sup>1</sup> / <sub>16</sub> x 9 <sup>3</sup> / <sub>4</sub> x 6 <sup>7</sup> / <sub>16</sub> inch	16	DDHT-09	13.1(5.95)
UFDHT-44-PX*	Rack w/100-Cell Hinged Plastic Storage Box	585 x 247 x 164 mm			13.1(5.95)+16*ω <sup>1</sup>
UFDHT-45	Rack Only	23 <sup>1</sup> / <sub>16</sub> x 12 <sup>1</sup> / <sub>8</sub> x 6 <sup>7</sup> / <sub>16</sub> inch	20	DDHT-11	16.1(7.30)
UFDHT-45-PX*	Rack w/100-Cell Hinged Plastic Storage Box	585 x 308 x 164 mm			16.1(7.30)+20*ω <sup>1</sup>
UFDHT-46	Rack Only	23 <sup>1</sup> / <sub>16</sub> x 14 <sup>1</sup> / <sub>2</sub> x 6 <sup>7</sup> / <sub>16</sub> inch	24	DDHT-14	18.5(8.64)
UFDHT-46-PX*	Rack w/100-Cell Hinged Plastic Storage Box	585 x 369 x 164 mm			18.5(8.64)+24*ω <sup>1</sup>

\* To order replace, X with color of box: O-orange, P-pink, Y-yellow, B-blue, G-green or N-natural.

\*\* ω<sup>1</sup>=0.22lb(0.1kg) for cardboard box, 0.37lb(0.17kg) for plastic box, 0.84lb(0.38kg) for stainless steel box, 0.53lb(0.24kg) for aluminum box.

## Chest Freezer Racks

### For 100 Cell Hinged Lid Storage Boxes

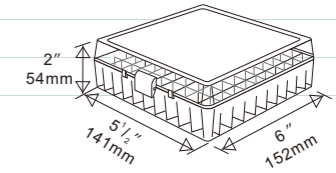

[ Check page 110 for Boxes ]

- ◆ Made of corrosion resistant stainless steel.
- ◆ Locking rods are included.
- ◆ Security lock devices are available for each rack.

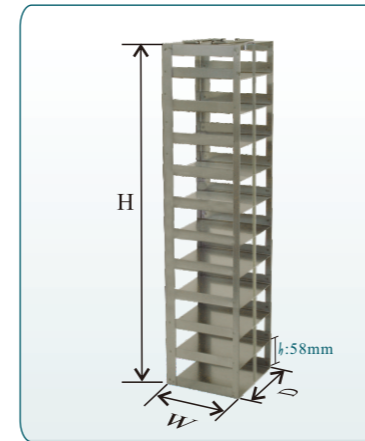

Chest Freezer Rack Only



Chest Freezer Rack w/100-Cell Hinged Plastic Storage Box



w/DR Lock Device Option

Part Number	Description	Dimension H x D x W	Capacity (Box)	Lock Device Option*	Shipping Weight lb(Kg)
CFHT-8	Rack Only	18 <sup>3</sup> / <sub>4</sub> x 5 <sup>7</sup> / <sub>8</sub> x 6 <sup>1</sup> / <sub>4</sub> inch	8	DR-17	3.6(1.62)
CFHT-8-PX*	Rack w/100-Cell Hinged Plastic Storage Box	476 x 149 x 159 mm			3.6(1.62)+8*ω <sup>1</sup>
CFHT-9	Rack Only	21 x 5 <sup>7</sup> / <sub>8</sub> x 6 <sup>1</sup> / <sub>4</sub> inch	9	DR-19	3.9(1.77)
CFHT-9-PX*	Rack w/100-Cell Hinged Plastic Storage Box	534 x 149 x 159 mm			3.9(1.77)+9*ω <sup>1</sup>
CFHT-10	Rack Only	23 <sup>3</sup> / <sub>8</sub> x 5 <sup>7</sup> / <sub>8</sub> x 6 <sup>1</sup> / <sub>4</sub> inch	10	DR-22	4.3(1.95)
CFHT-10-PX*	Rack w/100-Cell Hinged Plastic Storage Box	593 x 149 x 159 mm			4.3(1.95)+10*ω <sup>1</sup>
CFHT-11	Rack Only	25 <sup>5</sup> / <sub>8</sub> x 5 <sup>7</sup> / <sub>8</sub> x 6 <sup>1</sup> / <sub>4</sub> inch	11	DR-25	4.7(2.12)
CFHT-11-PX*	Rack w/100-Cell Hinged Plastic Storage Box	651 x 149 x 159 mm			4.7(2.12)+11*ω <sup>1</sup>
CFHT-12	Rack Only	27 <sup>15</sup> / <sub>16</sub> x 5 <sup>7</sup> / <sub>8</sub> x 6 <sup>1</sup> / <sub>4</sub> inch	12	DR-27	5.0(2.28)
CFHT-12-PX*	Rack w/100-Cell Hinged Plastic Storage Box	710 x 149 x 159 mm			5.0(2.28)+12*ω <sup>1</sup>
CFHT-13	Rack Only	30 <sup>1</sup> / <sub>4</sub> x 5 <sup>7</sup> / <sub>8</sub> x 6 <sup>1</sup> / <sub>4</sub> inch	13	DR-29	5.4(2.45)
CFHT-13-PX*	Rack w/100-Cell Hinged Plastic Storage Box	768 x 149 x 159 mm			5.4(2.45)+13*ω <sup>1</sup>

\* To order replace, X with color of box: O-orange, P-pink, Y-yellow, B-blue, G-green or N-natural.

\*\* Lock device is ordered separately.

\*\*\* ω<sup>1</sup>=0.22lb(0.1kg) for cardboard box, 0.37lb(0.17kg) for plastic box, 0.84lb(0.38kg) for stainless steel box, 0.53lb(0.24kg) for aluminum box.

# Upright Freezer Rack

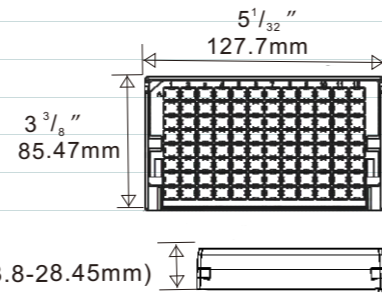

### For Matrix

500µl (0.5ml) Latch Rack (H=1 1/16 inch / 27.48mm)

### For Micronic

Loborack-96 with Low Cover (H= 15/16 inch / 23.8mm)

### For Fluidx

Low Profile 96-Format Rack for all 0.5ml and 0.75ml Tube with Low Profile Lid (H=1 inch / 26.0mm)

### For Abgene

0.3ml 2D Barcoded Storage Rack (H=1 1/8 inch / 28.45mm)

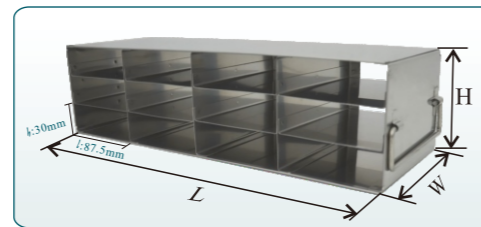

- ◆ Made of corrosion resistant stainless steel.
- ◆ Locking rods are included.

Part Number	Dimension L x H x W	Capacity	Shipping Weight(lb/Kg)
UFMM-43L	14 11/16 x 3 7/8 x 5 7/16 inch 373 x 98 x 138 mm	4 x 3 = 12	3.7 / 1.66
UFMM-44L	14 11/16 x 5 1/16 x 5 7/16 inch 373 x 129 x 138 mm	4 x 4 = 16	4.7 / 2.15
UFMM-45L	14 11/16 x 6 5/16 x 5 7/16 inch 373 x 160 x 138 mm	4 x 5 = 20	6.0 / 2.70
UFMM-46L	14 11/16 x 7 1/2 x 5 7/16 inch 373 x 191 x 138 mm	4 x 6 = 24	7.3 / 3.29
UFMM-53L	18 1/4 x 3 7/8 x 5 7/16 inch 463 x 98 x 138 mm	5 x 3 = 15	4.3 / 1.97
UFMM-54L	18 1/4 x 5 1/16 x 5 7/16 inch 463 x 129 x 138 mm	5 x 4 = 20	5.6 / 2.52
UFMM-55L	18 1/4 x 6 5/16 x 5 7/16 inch 463 x 160 x 138 mm	5 x 5 = 25	6.9 / 3.14
UFMM-56L	18 1/4 x 7 1/2 x 5 7/16 inch 463 x 191 x 138 mm	5 x 6 = 30	8.4 / 3.79
UFMM-63L	21 3/4 x 3 7/8 x 5 7/16 inch 552 x 98 x 138 mm	6 x 3 = 18	5.0 / 2.27
UFMM-64L	21 3/4 x 5 1/16 x 5 7/16 inch 552 x 129 x 138 mm	6 x 4 = 24	6.4 / 2.89
UFMM-65L	21 3/4 x 6 5/16 x 5 7/16 inch 552 x 160 x 138 mm	6 x 5 = 30	7.9 / 3.58
UFMM-66L	21 3/4 x 7 1/2 x 5 7/16 inch 552 x 191 x 138 mm	6 x 6 = 36	9.5 / 4.30

# Upright Freezer Rack

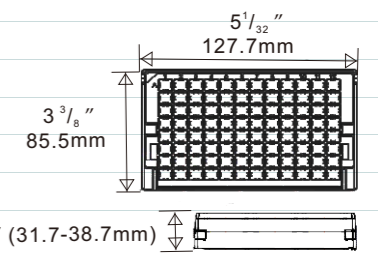

### For Micronic

Loborack-96 with Standard Cover (H=1 1/4 inch / 31.7mm)

Loborack-96 with High Cover (H=1 1/2 inch / 38.7mm)

### For Fluidx

Low Profile 96-Format Rack for all 0.5ml and 0.75ml Tube with Standard Profile Lid (H=1 5/16 inch / 32.9mm)

96-Format Rack for Tube with Protective Jacket with Low Cover (H=1 1/2 inch / 38mm)

### For Abgene

0.5ml 2D Barcoded Lock Storage Tube Rack (H=1 1/2 inch / 38.5mm)

0.6ml 2D Barcoded Storage Tube Rack (H=1 1/2 inch / 38.5mm)

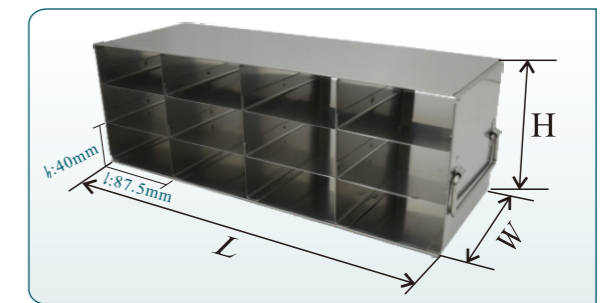

- ◆ Made of corrosion resistant stainless steel.
- ◆ Locking rods are included.

Part Number	Dimension L x H x W	Capacity	Shipping Weight(lb/Kg)
UFML-43L	14 11/16 x 5 1/16 x 5 7/16 inch 373 x 128 x 138 mm	4 x 3 = 12	3.8 / 1.74
UFML-44L	14 11/16 x 6 5/8 x 5 7/16 inch 373 x 168 x 138 mm	4 x 4 = 16	5.0 / 2.28
UFML-45L	14 11/16 x 8 1/4 x 5 7/16 inch 373 x 209 x 138 mm	4 x 5 = 20	6.3 / 2.86
UFML-46L	14 11/16 x 9 13/16 x 5 7/16 inch 373 x 249 x 138 mm	4 x 6 = 24	7.8 / 3.52
UFML-53L	18 1/4 x 5 1/16 x 5 7/16 inch 463 x 128 x 138 mm	5 x 3 = 15	4.5 / 2.05
UFML-54L	18 1/4 x 6 5/8 x 5 7/16 inch 463 x 168 x 138 mm	5 x 4 = 20	5.9 / 2.66
UFML-55L	18 1/4 x 8 1/4 x 5 7/16 inch 463 x 209 x 138 mm	5 x 5 = 25	7.3 / 3.31
UFML-56L	18 1/4 x 9 13/16 x 5 7/16 inch 463 x 249 x 138 mm	5 x 6 = 30	8.9 / 4.04
UFML-63L	21 3/4 x 5 1/16 x 5 7/16 inch 552 x 128 x 138 mm	6 x 3 = 18	5.2 / 2.35
UFML-64L	21 3/4 x 6 5/8 x 5 7/16 inch 552 x 168 x 138 mm	6 x 4 = 24	6.6 / 2.99
UFML-65L	21 3/4 x 8 1/4 x 5 7/16 inch 552 x 209 x 138 mm	6 x 5 = 30	8.3 / 3.76
UFML-66L	21 3/4 x 9 13/16 x 5 7/16 inch 552 x 249 x 138 mm	6 x 6 = 36	10.1 / 4.56

# Upright Freezer Rack

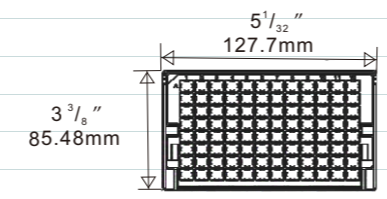

### For Matrix

- 500µl Screw-Top Latch Rack (H=1<sup>3</sup>/<sub>4</sub> inch / 44.32mm)
- 0.75ml Latch Rack (H=1<sup>1</sup>/<sub>2</sub> inch / 39.37mm)

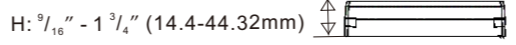

### For Fluidx

- 384-Format Rack for Square Tube (H=9/16 inch / 14.4mm, each compartment holds 3 racks.)
- Low Profile 96-Format Rack for all 0.5ml and 0.75ml Tube with Tall Profile Lid (H=1<sup>3</sup>/<sub>4</sub> inch / 43.87mm)
- 96-Format Rack for 1.0ml Tube with Low Profile Lid (H=1<sup>3</sup>/<sub>4</sub> inch / 43.9mm)
- 96-Format Rack for Tube with Protective Jacket with Standard Profile Lid (H=1<sup>3</sup>/<sub>4</sub> inch / 44.9mm)

### For Micronic

- Roborack-96 with Low Cover (H=1<sup>5</sup>/<sub>8</sub> inch / 41.2mm)

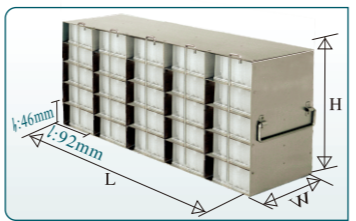

Rack w/ Locking Rod

- ◆ Made of corrosion resistant stainless steel.
- ◆ Locking rods are included.

Part Number	Dimension L x H x W	Capacity	Shipping Weight(lb/Kg)
UFDP-34L	11 <sup>1</sup> / <sub>2</sub> x 7 <sup>1</sup> / <sub>2</sub> x 5 <sup>1</sup> / <sub>2</sub> inch 292.5 x 191.1 x 140 mm	3 x 4 = 12	4.2 / 1.91
UFDP-35L	11 <sup>1</sup> / <sub>2</sub> x 9 <sup>3</sup> / <sub>8</sub> x 5 <sup>1</sup> / <sub>2</sub> inch 292.5 x 237.5 x 140 mm	3 x 5 = 15	5.0 / 2.28
UFDP-36L	11 <sup>1</sup> / <sub>2</sub> x 11 <sup>3</sup> / <sub>16</sub> x 5 <sup>1</sup> / <sub>2</sub> inch 292.5 x 283.5 x 140 mm	3 x 6 = 18	5.8 / 2.64
UFDP-44L	15 <sup>3</sup> / <sub>16</sub> x 7 <sup>1</sup> / <sub>2</sub> x 5 <sup>1</sup> / <sub>2</sub> inch 385.3 x 191.1 x 140 mm	4 x 4 = 16	5.4 / 2.47
UFDP-45L	15 <sup>3</sup> / <sub>16</sub> x 9 <sup>3</sup> / <sub>8</sub> x 5 <sup>1</sup> / <sub>2</sub> inch 385.3 x 237.5 x 140 mm	4 x 5 = 20	6.5 / 2.95
UFDP-46L	15 <sup>3</sup> / <sub>16</sub> x 11 <sup>3</sup> / <sub>16</sub> x 5 <sup>1</sup> / <sub>2</sub> inch 385.3 x 283.5 x 140 mm	4 x 6 = 24	7.5 / 3.42
UFDP-54L	18 <sup>13</sup> / <sub>16</sub> x 7 <sup>1</sup> / <sub>2</sub> x 5 <sup>1</sup> / <sub>2</sub> inch 478.1 x 191.1 x 140 mm	5 x 4 = 20	6.7 / 3.03
UFDP-55L	18 <sup>13</sup> / <sub>16</sub> x 9 <sup>5</sup> / <sub>16</sub> x 5 <sup>1</sup> / <sub>2</sub> inch 478.1 x 237 x 140 mm	5 x 5 = 25	8.2 / 3.72
UFDP-56L	18 <sup>13</sup> / <sub>16</sub> x 11 <sup>3</sup> / <sub>16</sub> x 5 <sup>1</sup> / <sub>2</sub> inch 478.1 x 284 x 140 mm	5 x 6 = 30	9.5 / 4.32
UFDP-64L	22 <sup>1</sup> / <sub>2</sub> x 7 <sup>1</sup> / <sub>2</sub> x 5 <sup>1</sup> / <sub>2</sub> inch 571 x 191.1 x 140 mm	6 x 4 = 24	8.0 / 3.62
UFDP-65L	22 <sup>1</sup> / <sub>2</sub> x 9 <sup>5</sup> / <sub>16</sub> x 5 <sup>1</sup> / <sub>2</sub> inch 571 x 237 x 140 mm	6 x 5 = 30	9.8 / 4.43
UFDP-66L	22 <sup>1</sup> / <sub>2</sub> x 11 <sup>3</sup> / <sub>16</sub> x 5 <sup>1</sup> / <sub>2</sub> inch 571 x 284 x 140 mm	6 x 6 = 36	11.3 / 5.13
UFDP-74L	26 <sup>1</sup> / <sub>8</sub> x 7 <sup>1</sup> / <sub>2</sub> x 5 <sup>1</sup> / <sub>2</sub> inch 663.7 x 191.1 x 140 mm	7 x 4 = 28	9.2 / 4.17
UFDP-75L	25 <sup>1</sup> / <sub>8</sub> x 9 <sup>3</sup> / <sub>8</sub> x 5 <sup>1</sup> / <sub>2</sub> inch 663.7 x 237.5 x 140 mm	7 x 5 = 35	11.3 / 5.11
UFDP-76L	25 <sup>1</sup> / <sub>8</sub> x 11 <sup>3</sup> / <sub>16</sub> x 5 <sup>1</sup> / <sub>2</sub> inch 663.7 x 283.5 x 140 mm	7 x 6 = 42	13.1 / 5.93

# Upright Freezer Rack

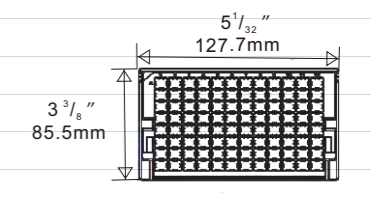

### For Matrix

- 1.4ml Latch Rack (H=1<sup>15</sup>/<sub>16</sub> inch / 49.84mm)

### For Micronic

- Roborack-96 with Standard Cover (H=1<sup>15</sup>/<sub>16</sub> inch / 49.1mm)
- Comorack-96 (H=2 inch / 52mm)
- Comorack-24 (H=2 inch / 58mm)

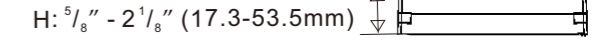

### For Fluidx

- 384-Format Rack for Round Tube (H=5/8 inch / 17.1mm, each compartment holds 3 racks.)
- 96-Format Rack for 1.0ml and 1.4ml Tube with Standard Profile Lid (H=2 inch / 50.8mm)
- 48-Format Rack for Cryo Tube with Standard Profile Lid (H=2<sup>1</sup>/<sub>16</sub> inch / 52.8mm)
- 48-Format Rack for Glass Tube (H=2 inch / 51.6mm)

### For Abgene

- 2.0ml 2D Barcoded Screw Cap Storage Tube Rack (H=2<sup>1</sup>/<sub>16</sub> inch / 52.5mm)
- 1.0ml 2D Barcoded Twist Lock Storage Tube Rack (H=2<sup>1</sup>/<sub>8</sub> inch / 53.5mm)

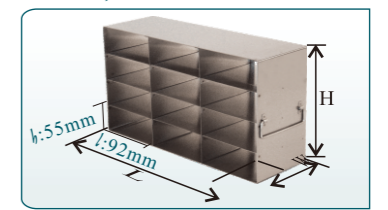

- ◆ Made of corrosion resistant stainless steel.
- ◆ Locking rods are included.

Part Number	Dimension L x H x W	Capacity	Lock Device Option*	Shipping Weight(lb/Kg)
UFTB-33L	11 <sup>9</sup> / <sub>16</sub> x 6 <sup>13</sup> / <sub>16</sub> x 5 <sup>1</sup> / <sub>2</sub> inch 293 x 173 x 140 mm	3 x 3 = 9	DP-1107	3.7 / 1.70
UFTB-34L	11 <sup>9</sup> / <sub>16</sub> x 9 x 5 <sup>1</sup> / <sub>2</sub> inch 293 x 228 x 140 mm	3 x 4 = 12	DP-1109	4.7 / 2.12
UFTB-35L	11 <sup>9</sup> / <sub>16</sub> x 11 <sup>3</sup> / <sub>16</sub> x 5 <sup>1</sup> / <sub>2</sub> inch 293 x 284 x 140 mm	3 x 5 = 15	DP-1111	5.6 / 2.53
UFTB-36L	11 <sup>9</sup> / <sub>16</sub> x 13 <sup>3</sup> / <sub>8</sub> x 5 <sup>1</sup> / <sub>2</sub> inch 293 x 339 x 140 mm	3 x 6 = 18	DP-1113	6.5 / 2.95
UFTB-43L	15 <sup>3</sup> / <sub>16</sub> x 6 <sup>13</sup> / <sub>16</sub> x 5 <sup>1</sup> / <sub>2</sub> inch 385 x 173 x 140 mm	4 x 3 = 12	DP-1407	4.9 / 2.20
UFTB-44L	15 <sup>3</sup> / <sub>16</sub> x 9 x 5 <sup>1</sup> / <sub>2</sub> inch 385 x 228 x 140 mm	4 x 4 = 16	DP-1409	6.0 / 2.74
UFTB-45L	15 <sup>3</sup> / <sub>16</sub> x 11 <sup>3</sup> / <sub>16</sub> x 5 <sup>1</sup> / <sub>2</sub> inch 385 x 284 x 140 mm	4 x 5 = 20	DP-1411	7.2 / 3.27
UFTB-46L	15 <sup>3</sup> / <sub>16</sub> x 13 <sup>3</sup> / <sub>8</sub> x 5 <sup>1</sup> / <sub>2</sub> inch 385 x 339 x 140 mm	4 x 6 = 24	DP-1413	8.4 / 3.81
UFTB-53L	18 <sup>13</sup> / <sub>16</sub> x 6 <sup>13</sup> / <sub>16</sub> x 5 <sup>1</sup> / <sub>2</sub> inch 478 x 173 x 140 mm	5 x 3 = 15	DP-1807	5.9 / 2.69
UFTB-54L	18 <sup>13</sup> / <sub>16</sub> x 9 x 5 <sup>1</sup> / <sub>2</sub> inch 478 x 228 x 140 mm	5 x 4 = 20	DP-1809	7.4 / 3.36
UFTB-55L	18 <sup>13</sup> / <sub>16</sub> x 11 <sup>3</sup> / <sub>16</sub> x 5 <sup>1</sup> / <sub>2</sub> inch 478 x 284 x 140 mm	5 x 5 = 25	DP-1811	8.9 / 4.02
UFTB-56L	18 <sup>13</sup> / <sub>16</sub> x 13 <sup>3</sup> / <sub>8</sub> x 5 <sup>1</sup> / <sub>2</sub> inch 478 x 339 x 140 mm	5 x 6 = 30	DP-1813	10.3 / 4.68
UFTB-63L	22 <sup>1</sup> / <sub>2</sub> x 6 <sup>13</sup> / <sub>16</sub> x 5 <sup>1</sup> / <sub>2</sub> inch 571 x 173 x 140 mm	6 x 3 = 18	DP-2207	7.0 / 3.17
UFTB-64L	22 <sup>1</sup> / <sub>2</sub> x 9 x 5 <sup>1</sup> / <sub>2</sub> inch 571 x 228 x 140 mm	6 x 4 = 24	DP-2209	8.8 / 3.97
UFTB-65L	22 <sup>1</sup> / <sub>2</sub> x 11 <sup>3</sup> / <sub>16</sub> x 5 <sup>1</sup> / <sub>2</sub> inch 571 x 284 x 140 mm	6 x 5 = 30	DP-2211	10.5 / 4.76
UFTB-66L	22 <sup>1</sup> / <sub>2</sub> x 13 <sup>3</sup> / <sub>8</sub> x 5 <sup>1</sup> / <sub>2</sub> inch 571 x 339 x 140 mm	6 x 6 = 36	DP-2213	12.2 / 5.54
UFTB-73L	26 <sup>1</sup> / <sub>8</sub> x 6 <sup>13</sup> / <sub>16</sub> x 5 <sup>1</sup> / <sub>2</sub> inch 664 x 173 x 140 mm	7 x 3 = 21	DP-2607	8.1 / 3.68
UFTB-74L	26 <sup>1</sup> / <sub>8</sub> x 9 x 5 <sup>1</sup> / <sub>2</sub> inch 664 x 228 x 140 mm	7 x 4 = 28	DP-2609	10.1 / 4.59
UFTB-75L	26 <sup>1</sup> / <sub>8</sub> x 11 <sup>3</sup> / <sub>16</sub> x 5 <sup>1</sup> / <sub>2</sub> inch 664 x 284 x 140 mm	7 x 5 = 35	DP-2611	11.9 / 5.42
UFTB-76L	26 <sup>1</sup> / <sub>8</sub> x 13 <sup>3</sup> / <sub>8</sub> x 5 <sup>1</sup> / <sub>2</sub> inch 664 x 339 x 140 mm	7 x 6 = 42	DP-2613	14.2 / 6.42



## Upright Freezer Rack

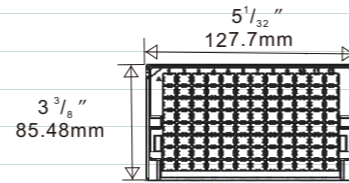

### For Matrix

1.0ml Screw-Top Latch Rack (H=2 1/8 inch / 54.8mm)

H: 2 5/16" - 2 7/16" (54.8-61.8mm)

### For Micronic

Roborack-96 with High Cover (H=2 1/4 inch / 56.1mm)

### For Fluidx

96-Format Rack for Tube with Protective Jacket with Tall Profile Lid (H=2 3/16 inch / 55mm)

96-Format Rack Tack for 1.0ml and 1.4ml Tube with Tall Profile Lid (H=2 7/16 inch / 61.8mm)

24-Format Rack (H=2 1/4 inch / 56mm)

### For Abgene

1.2ml 2D Barcoded Tube in Stackable Rack (H=2 1/4 inch / 56.13mm)

1.2ml 2D Barcoded Storage Tube Rack (H=2 1/4 inch / 56.13mm)

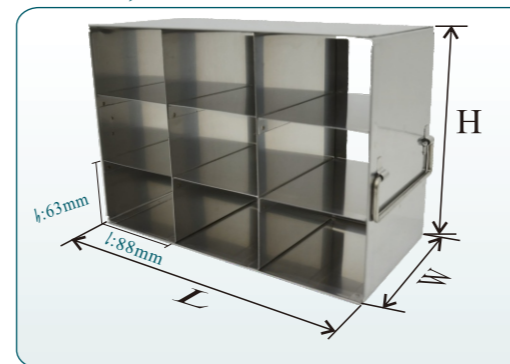

- ◆ Made of corrosion resistant stainless steel.
- ◆ Locking rods are included.

Part Number	Dimension L x H x W	Capacity	Shipping Weight(lb/Kg)
UFMX-332L	11 1/8 x 7 11/16 x 5 7/16 inch 283 x 195 x 138 mm	3 x 3 = 9	3.9 / 1.75
UFMX-342L	11 1/8 x 10 3/16 x 5 7/16 inch 283 x 258 x 138 mm	3 x 4 = 12	4.8 / 2.19
UFMX-352L	11 1/8 x 12 5/8 x 5 7/16 inch 283 x 321 x 138 mm	3 x 5 = 15	5.8 / 2.62
UFMX-432L	14 11/16 x 7 11/16 x 5 7/16 inch 373 x 195 x 138 mm	4 x 3 = 12	5.0 / 2.25
UFMX-442L	14 11/16 x 10 3/16 x 5 7/16 inch 373 x 258 x 138 mm	4 x 4 = 16	6.2 / 2.82
UFMX-452L	14 11/16 x 12 5/8 x 5 7/16 inch 373 x 321 x 138 mm	4 x 5 = 20	7.5 / 3.38
UFMX-532L	18 1/4 x 7 11/16 x 5 7/16 inch 463 x 195 x 138 mm	5 x 3 = 15	6.1 / 2.75
UFMX-542L	18 1/4 x 10 3/16 x 5 7/16 inch 463 x 258 x 138 mm	5 x 4 = 20	7.6 / 3.45
UFMX-552L	18 1/4 x 12 5/8 x 5 7/16 inch 463 x 321 x 138 mm	5 x 5 = 25	9.1 / 4.14
UFMX-562L	18 1/4 x 15 1/8 x 5 7/16 inch 463 x 384 x 138 mm	5 x 6 = 30	10.5 / 4.75
UFMX-632L	21 3/4 x 7 11/16 x 5 7/16 inch 552 x 195 x 138 mm	6 x 3 = 18	7.2 / 3.26
UFMX-642L	21 3/4 x 10 3/16 x 5 7/16 inch 552 x 258 x 138 mm	6 x 4 = 24	9.0 / 4.08
UFMX-652L	21 3/4 x 12 5/8 x 5 7/16 inch 552 x 321 x 138 mm	6 x 5 = 30	10.8 / 4.89
UFMX-662L	21 3/4 x 15 1/8 x 5 7/16 inch 552 x 384 x 138 mm	6 x 6 = 36	12.4 / 5.61

## Upright Freezer Rack

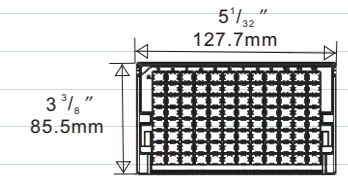

### For Micronic

Roborack-96 with Extra High Cover (H=3 1/2 inch / 88.5mm)

### For Fluidx

48-Format Rack for Cryo Tube with Tall Profile Lid (H=3 1/2 inch / 88.5mm)

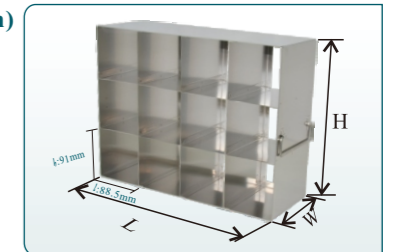

- ◆ Made of corrosion resistant stainless steel.
- ◆ Locking rods are included.

Part Number	Dimension L x H x W	Capacity	Shipping Weight(lb/Kg)
UFMH-42L	14 11/16 x 7 7/16 x 5 3/8 inch 373 x 189 x 138 mm	8	4.0 / 1.82
UFMH-43L	14 11/16 x 11 1/16 x 5 3/8 inch 373 x 281 x 138 mm	12	5.4 / 2.47
UFMH-52L	18 3/16 x 7 7/16 x 5 3/8 inch 462 x 189 x 138 mm	10	4.9 / 2.23
UFMH-53L	18 3/16 x 11 1/16 x 5 3/8 inch 462 x 281 x 138 mm	15	6.5 / 2.96

### For Matrix

12ml Screw-Top Latch Rack Boxes (H=4 1/4 inch / 107.82mm)

### For Abgene

5.0ml 2D Barcoded Screw Cap Storage Tube Rack (H=4 inch / 101.5mm)

- ◆ Made of corrosion resistant stainless steel.
- ◆ Locking rods are included.

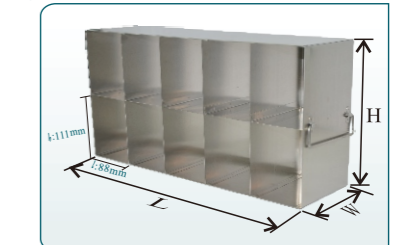
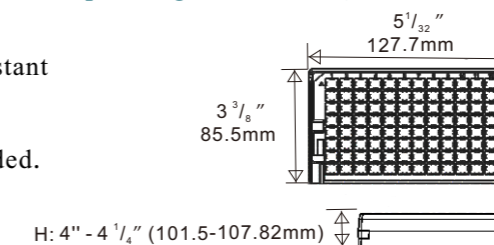

Part Number	Dimension L x H x W	Capacity	Shipping Weight(lb/Kg)
UFMR-42L	14 11/16 x 9 x 5 7/16 inch 373 x 229 x 138 mm	4 x 2 = 8	4.8 / 2.17
UFMR-43L	14 11/16 x 13 3/8 x 5 7/16 inch 373 x 340 x 138 mm	4 x 3 = 12	6.6 / 2.98
UFMR-52L	18 1/4 x 9 x 5 7/16 inch 463 x 229 x 138 mm	5 x 2 = 10	5.8 / 2.64
UFMR-53L	18 1/4 x 13 3/8 x 5 7/16 inch 463 x 340 x 138 mm	5 x 3 = 15	8.0 / 3.63
UFMR-62L	21 3/4 x 9 x 5 7/16 inch 552 x 229 x 138 mm	6 x 2 = 12	6.9 / 3.13
UFMR-63L	21 3/4 x 13 3/8 x 5 7/16 inch 552 x 340 x 138 mm	6 x 3 = 18	9.5 / 4.29
UFMR-72L	25 1/4 x 9 x 5 7/16 inch 642 x 229 x 138 mm	7 x 2 = 14	8.0 / 3.62
UFMR-73L	25 1/4 x 13 3/8 x 5 7/16 inch 642 x 340 x 138 mm	7 x 3 = 21	10.7 / 4.85

## Upright Drawer Freezer Rack

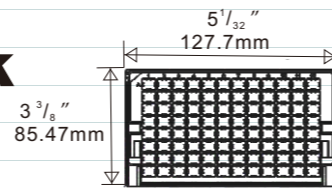

### For Matrix

500µl (0.5ml) Latch Rack (H=1 1/16 inch / 27.48mm)

### For Micronic

Loborack-96 with Low Cover (H=1 5/16 inch / 23.8mm)

### For Fluidx

Low Profile 96-Format Rack for all 0.5ml and 0.75ml Tube with Low Profile Lid (H=1 inch / 26.0mm)

### For Abgene

0.3ml 2D Barcoded Storage Rack (H=1 1/8 inch / 28.45mm)

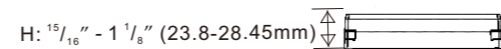

- ◆ Made of corrosion resistant stainless steel.
- ◆ Drawer racks allow easy access to and storage of samples without having to remove the whole rack from the freezer.

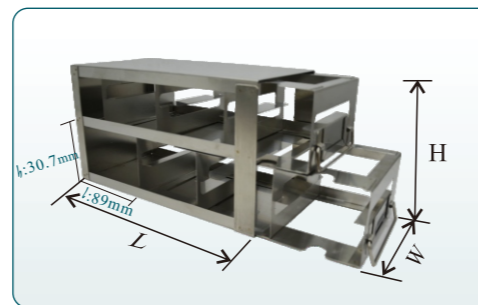

Part Number	Dimension L x H x W	Capacity	Shipping Weight (lb/Kg)
UFDMM-32	11 3/16 x 5 3/8 x 5 7/16 inch 283.4 x 136 x 138 mm	3 x 2 x 2 = 12	4.0 / 1.83
UFDMM-33	11 3/16 x 8 x 5 7/16 inch 283.4 x 203.4 x 138 mm	3 x 3 x 2 = 18	5.7 / 2.60
UFDMM-34	11 3/16 x 10 11/16 x 5 7/16 inch 283.4 x 271 x 138 mm	3 x 4 x 2 = 24	7.5 / 3.38
UFDMM-42	14 9/16 x 5 3/8 x 5 7/16 inch 370 x 136 x 138 mm	4 x 2 x 2 = 16	5.0 / 2.27
UFDMM-43	14 9/16 x 8 x 5 7/16 inch 370 x 203.4 x 138 mm	4 x 3 x 2 = 24	7.1 / 3.24
UFDMM-44	14 9/16 x 10 11/16 x 5 7/16 inch 370 x 271 x 138 mm	4 x 4 x 2 = 32	9.3 / 4.22
UFDMM-52	18 1/8 x 5 3/8 x 5 7/16 inch 459.6 x 136 x 138 mm	5 x 2 x 2 = 20	6.0 / 2.74
UFDMM-53	18 1/8 x 8 x 5 7/16 inch 459.6 x 203.4 x 138 mm	5 x 3 x 2 = 30	8.6 / 3.91
UFDMM-54	18 1/8 x 10 11/16 x 5 7/16 inch 459.6 x 271 x 138 mm	5 x 4 x 2 = 40	11.2 / 5.08
UFDMM-62	21 5/8 x 5 3/8 x 5 7/16 inch 549.2 x 136 x 138 mm	6 x 2 x 2 = 24	7.0 / 3.19
UFDMM-63	21 5/8 x 8 x 5 7/16 inch 549.2 x 203.4 x 138 mm	6 x 3 x 2 = 36	10.0 / 4.54
UFDMM-64	21 5/8 x 10 11/16 x 5 7/16 inch 549.2 x 271 x 138 mm	6 x 4 x 2 = 48	13.0 / 5.90

## Upright Freezer Drawer Rack

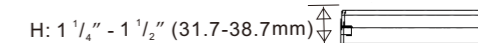
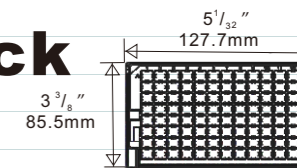

### For Micronic

Loborack-96 with Standard Cover (H=1 1/4 inch / 31.7mm)

Loborack-96 with High Cover (H=1 1/2 inch / 38.7mm)

### For Fluidx

Low Profile 96-Format Rack for all 0.5ml and 0.75ml Tube with Standard Profile Lid (H=1 5/16 inch / 32.9mm)

96-Format Rack for Tube with Protective Jacket with Low Cover (H=1 1/2 inch / 38mm)

### For Abgene

0.5ml 2D Barcoded Lock Storage Tube Rack (H=1 1/2 inch / 38.5mm)

0.6ml 2D Barcoded Storage Tube Rack (H=1 1/2 inch / 38.5mm)

- ◆ Made of corrosion resistant stainless steel.
- ◆ Drawer racks allow easy access to and storage of samples without having to remove the whole rack from the freezer.

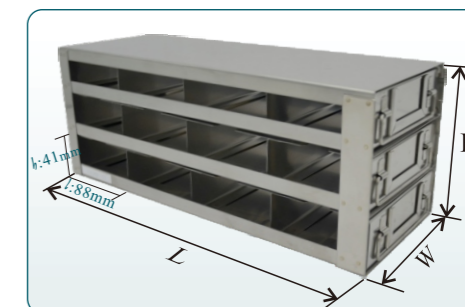

Part Number	Dimension L x H x W	Capacity	Shipping Weight (lb/Kg)
UFDML-43	14 7/16 x 5 9/16 x 5 7/16 inch 366 x 142 x 138 mm	4 x 3 = 12	6.0 / 2.73
UFDML-44	14 7/16 x 7 7/8 x 5 7/16 inch 366 x 188 x 138 mm	4 x 4 = 16	7.8 / 3.53
UFDML-45	14 7/16 x 9 1/4 x 5 7/16 inch 366 x 235 x 138 mm	4 x 5 = 20	9.5 / 4.33
UFDML-46	14 7/16 x 11 1/16 x 5 7/16 inch 366 x 281 x 138 mm	4 x 6 = 24	11.3 / 5.13
UFDML-53	17 7/8 x 5 9/16 x 5 7/16 inch 454 x 142 x 138 mm	5 x 3 = 15	7.3 / 3.31
UFDML-54	17 7/8 x 7 3/8 x 5 7/16 inch 454 x 188 x 138 mm	5 x 4 = 20	9.4 / 4.27
UFDML-55	17 7/8 x 9 1/4 x 5 7/16 inch 454 x 235 x 138 mm	5 x 5 = 25	11.6 / 5.24
UFDML-56	17 7/8 x 11 1/16 x 5 7/16 inch 454 x 281 x 138 mm	5 x 6 = 30	13.7 / 6.21
UFDML-63	21 3/8 x 5 9/16 x 5 7/16 inch 543 x 142 x 138 mm	6 x 3 = 18	8.6 / 3.88
UFDML-64	21 3/8 x 7 3/8 x 5 7/16 inch 543 x 188 x 138 mm	6 x 4 = 24	11.1 / 5.02
UFDML-65	21 3/8 x 9 1/4 x 5 7/16 inch 543 x 235 x 138 mm	6 x 5 = 30	15.1 / 6.86
UFDML-66	21 3/8 x 11 1/16 x 5 7/16 inch 543 x 281 x 138 mm	6 x 6 = 36	16.1 / 7.29

# Upright Freezer Drawer Rack

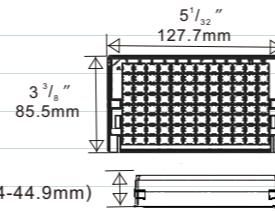

## For Matrix

- 500µl Screw-Top Latch Rack (H=1<sup>3</sup>/<sub>4</sub> inch / 44.32mm)
- 0.75ml Latch Rack (H=1<sup>1</sup>/<sub>2</sub> inch / 39.37mm)

## For Micronic

- Roborack-96 with Low Cover (H=1<sup>5</sup>/<sub>8</sub> inch / 41.2mm)

## For Fluidx

- 384-Format Rack for Square Tube (H=9/<sub>16</sub> inch / 14.4mm, each compartment holds 3 racks.)
- Low Profile 96-Format Rack for all 0.5ml and 0.75ml Tube with Tall Profile Lid (H=1<sup>3</sup>/<sub>4</sub> inch / 43.87mm)
- 96-Format Rack for 1.0ml Tube with Low Profile Lid (H=1<sup>3</sup>/<sub>4</sub> inch / 43.9mm)
- 96-Format Rack for Tube with Protective Jacket with Standard Profile Lid (H=1<sup>3</sup>/<sub>4</sub> inch / 44.9mm)

- Made of corrosion resistant stainless steel.
- Drawer racks allow easy access to and storage of samples without having to remove the whole rack from the freezer.

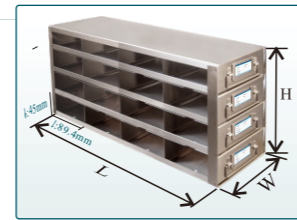

Part Number	Dimension L x H x W	Capacity	Shipping Weight(lb/Kg)
UFDDP-33	11 <sup>1</sup> / <sub>8</sub> x 6 <sup>1</sup> / <sub>16</sub> x 5 <sup>7</sup> / <sub>16</sub> inch 282 x 154 x 138 mm	3 x 3 = 9	5.2 / 2.38
UFDDP-34	11 <sup>1</sup> / <sub>8</sub> x 8 <sup>1</sup> / <sub>16</sub> x 5 <sup>7</sup> / <sub>16</sub> inch 282 x 205 x 138 mm	3 x 4 = 12	6.8 / 3.09
UFDDP-35	11 <sup>1</sup> / <sub>8</sub> x 10 <sup>1</sup> / <sub>16</sub> x 5 <sup>7</sup> / <sub>16</sub> inch 282 x 256 x 138 mm	3 x 5 = 15	8.4 / 3.79
UFDDP-36	11 <sup>1</sup> / <sub>8</sub> x 12 <sup>1</sup> / <sub>8</sub> x 5 <sup>7</sup> / <sub>16</sub> inch 282 x 307.2 x 138 mm	3 x 6 = 18	9.9 / 4.50
UFDDP-37	11 <sup>1</sup> / <sub>8</sub> x 14 <sup>1</sup> / <sub>8</sub> x 5 <sup>7</sup> / <sub>16</sub> inch 282 x 358 x 138 mm	3 x 7 = 21	11.7 / 5.30
UFDDP-43	14 <sup>2</sup> / <sub>8</sub> x 6 <sup>1</sup> / <sub>16</sub> x 5 <sup>7</sup> / <sub>16</sub> inch 372 x 154 x 138 mm	4 x 3 = 12	6.6 / 3.00
UFDDP-44	14 <sup>2</sup> / <sub>8</sub> x 8 <sup>1</sup> / <sub>16</sub> x 5 <sup>7</sup> / <sub>16</sub> inch 372 x 205 x 138 mm	4 x 4 = 16	8.6 / 3.89
UFDDP-45	14 <sup>2</sup> / <sub>8</sub> x 10 <sup>1</sup> / <sub>16</sub> x 5 <sup>7</sup> / <sub>16</sub> inch 372 x 256 x 138 mm	4 x 5 = 20	10.5 / 4.77
UFDDP-46	14 <sup>2</sup> / <sub>8</sub> x 12 <sup>1</sup> / <sub>8</sub> x 5 <sup>7</sup> / <sub>16</sub> inch 372 x 307.2 x 138 mm	4 x 6 = 24	12.5 / 5.66
UFDDP-47	14 <sup>2</sup> / <sub>8</sub> x 14 <sup>1</sup> / <sub>8</sub> x 5 <sup>7</sup> / <sub>16</sub> inch 372 x 358 x 138 mm	4 x 7 = 28	14.6 / 6.60
UFDDP-53	18 <sup>3</sup> / <sub>16</sub> x 6 <sup>1</sup> / <sub>16</sub> x 5 <sup>7</sup> / <sub>16</sub> inch 462 x 154 x 138 mm	5 x 3 = 15	8.0 / 3.61
UFDDP-54	18 <sup>3</sup> / <sub>16</sub> x 8 <sup>1</sup> / <sub>16</sub> x 5 <sup>7</sup> / <sub>16</sub> inch 462 x 205 x 138 mm	5 x 4 = 20	10.3 / 4.68
UFDDP-55	18 <sup>3</sup> / <sub>16</sub> x 10 <sup>1</sup> / <sub>16</sub> x 5 <sup>7</sup> / <sub>16</sub> inch 462 x 256 x 138 mm	5 x 5 = 25	12.7 / 5.75
UFDDP-56	18 <sup>3</sup> / <sub>16</sub> x 12 <sup>1</sup> / <sub>8</sub> x 5 <sup>7</sup> / <sub>16</sub> inch 462 x 307.2 x 138 mm	5 x 6 = 30	15.0 / 6.81
UFDDP-57	18 <sup>3</sup> / <sub>16</sub> x 14 <sup>1</sup> / <sub>8</sub> x 5 <sup>7</sup> / <sub>16</sub> inch 462 x 358 x 138 mm	5 x 7 = 35	17.4 / 7.90
UFDDP-63	21 <sup>3</sup> / <sub>4</sub> x 6 <sup>1</sup> / <sub>16</sub> x 5 <sup>7</sup> / <sub>16</sub> inch 552 x 154 x 138 mm	6 x 3 = 18	9.3 / 4.23
UFDDP-64	21 <sup>3</sup> / <sub>4</sub> x 8 <sup>1</sup> / <sub>16</sub> x 5 <sup>7</sup> / <sub>16</sub> inch 552 x 205 x 138 mm	6 x 4 = 24	12.1 / 5.48
UFDDP-65	21 <sup>3</sup> / <sub>4</sub> x 10 <sup>1</sup> / <sub>16</sub> x 5 <sup>7</sup> / <sub>16</sub> inch 552 x 256 x 138 mm	6 x 5 = 30	14.8 / 6.73
UFDDP-66	21 <sup>3</sup> / <sub>4</sub> x 12 <sup>1</sup> / <sub>8</sub> x 5 <sup>7</sup> / <sub>16</sub> inch 552 x 307.2 x 138 mm	6 x 6 = 36	17.6 / 7.97
UFDDP-67	21 <sup>3</sup> / <sub>4</sub> x 14 <sup>1</sup> / <sub>8</sub> x 5 <sup>7</sup> / <sub>16</sub> inch 552 x 358 x 138 mm	6 x 7 = 42	20.3 / 9.20
UFDDP-73	25 <sup>3</sup> / <sub>16</sub> x 6 <sup>1</sup> / <sub>16</sub> x 5 <sup>7</sup> / <sub>16</sub> inch 642 x 154 x 138 mm	7 x 3 = 21	10.7 / 4.84
UFDDP-74	25 <sup>3</sup> / <sub>16</sub> x 8 <sup>1</sup> / <sub>16</sub> x 5 <sup>7</sup> / <sub>16</sub> inch 642 x 205 x 138 mm	7 x 4 = 28	13.8 / 6.27
UFDDP-75	25 <sup>3</sup> / <sub>16</sub> x 10 <sup>1</sup> / <sub>16</sub> x 5 <sup>7</sup> / <sub>16</sub> inch 642 x 256 x 138 mm	7 x 5 = 35	17.0 / 7.70
UFDDP-76	25 <sup>3</sup> / <sub>16</sub> x 12 <sup>1</sup> / <sub>8</sub> x 5 <sup>7</sup> / <sub>16</sub> inch 642 x 307 x 138 mm	7 x 6 = 42	20.1 / 9.12
UFDDP-77	25 <sup>3</sup> / <sub>16</sub> x 14 <sup>1</sup> / <sub>8</sub> x 5 <sup>7</sup> / <sub>16</sub> inch 642 x 358 x 138 mm	7 x 7 = 49	23.4 / 10.63

# Upright Freezer Drawer Rack

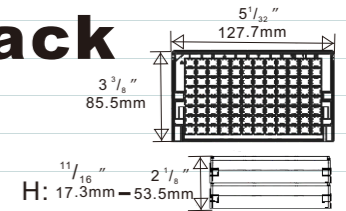

## For Matrix

- 1.4ml Latch Rack (H=1<sup>15</sup>/<sub>16</sub> inch / 49.84mm)

## For Micronic

- Roborack-96 with Standard Cover (H=1<sup>15</sup>/<sub>16</sub> inch / 49.1mm)
- Comorack-96 (H=2 inch / 52mm)
- Comorack-24 (H=2 inch / 52mm)

## For Fluidx

- 384-Format Rack for Round Tube (H=1<sup>1</sup>/<sub>16</sub> inch / 17.1mm, each compartment holds 3 racks.)
- 96-Format Rack for 1.0ml and 1.4ml Tube with Standard Profile Lid (H=2 inch / 50.8mm)
- 48-Format Rack for Cryo Tube with Standard Profile Lid (H=2<sup>1</sup>/<sub>16</sub> inch / 52.8mm)
- 48-Format Rack for Glass Tube (H=2 inch / 51.6mm)

## For Abgene

- 2.0ml 2D Barcoded Screw Cap Storage Tube Rack (H=2 inch / 52.5mm)
- 1.0ml 2D Barcoded Twist Lock Storage Tube Rack (H=2<sup>1</sup>/<sub>8</sub> inch / 53.5mm)

- Made of corrosion resistant stainless steel.
- Drawer racks allow easy access to and storage of samples without having to remove the whole rack from the freezer.

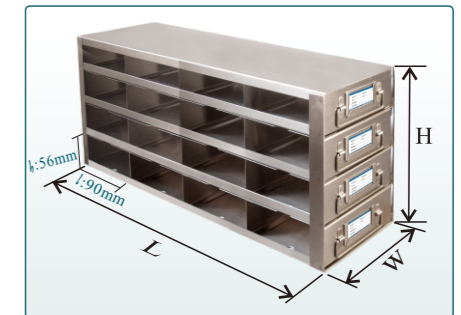

Part Number	Dimension L x H x W	Capacity	Shipping Weight(lb/Kg)
UFDMP-33	11 <sup>1</sup> / <sub>8</sub> x 7 <sup>5</sup> / <sub>16</sub> x 5 <sup>7</sup> / <sub>16</sub> inch 282 x 186 x 138 mm	3 x 3 = 9	5.4 / 2.45
UFDMP-34	11 <sup>1</sup> / <sub>8</sub> x 9 <sup>3</sup> / <sub>4</sub> x 5 <sup>7</sup> / <sub>16</sub> inch 282 x 247 x 138 mm	3 x 4 = 12	6.9 / 3.13
UFDMP-35	11 <sup>1</sup> / <sub>8</sub> x 12 <sup>1</sup> / <sub>8</sub> x 5 <sup>7</sup> / <sub>16</sub> inch 282 x 308 x 138 mm	3 x 5 = 15	8.6 / 3.90
UFDMP-36	11 <sup>1</sup> / <sub>8</sub> x 14 <sup>1</sup> / <sub>2</sub> x 5 <sup>7</sup> / <sub>16</sub> inch 282 x 369 x 138 mm	3 x 6 = 18	10.2 / 4.64
UFDMP-43	14 <sup>2</sup> / <sub>8</sub> x 7 <sup>5</sup> / <sub>16</sub> x 5 <sup>7</sup> / <sub>16</sub> inch 372 x 186 x 138 mm	4 x 3 = 12	6.8 / 3.10
UFDMP-44	14 <sup>2</sup> / <sub>8</sub> x 9 <sup>3</sup> / <sub>4</sub> x 5 <sup>7</sup> / <sub>16</sub> inch 372 x 247 x 138 mm	4 x 4 = 16	8.9 / 4.02
UFDMP-45	14 <sup>2</sup> / <sub>8</sub> x 12 <sup>1</sup> / <sub>8</sub> x 5 <sup>7</sup> / <sub>16</sub> inch 372 x 308 x 138 mm	4 x 5 = 20	10.9 / 4.94
UFDMP-46	14 <sup>2</sup> / <sub>8</sub> x 14 <sup>1</sup> / <sub>2</sub> x 5 <sup>7</sup> / <sub>16</sub> inch 372 x 369 x 138 mm	4 x 6 = 24	12.9 / 5.86
UFDMP-53	18 <sup>3</sup> / <sub>16</sub> x 7 <sup>5</sup> / <sub>16</sub> x 5 <sup>7</sup> / <sub>16</sub> inch 462 x 186 x 138 mm	5 x 3 = 15	8.2 / 3.70
UFDMP-54	18 <sup>3</sup> / <sub>16</sub> x 9 <sup>3</sup> / <sub>4</sub> x 5 <sup>7</sup> / <sub>16</sub> inch 462 x 247 x 138 mm	5 x 4 = 20	10.6 / 4.79
UFDMP-55	18 <sup>3</sup> / <sub>16</sub> x 12 <sup>1</sup> / <sub>8</sub> x 5 <sup>7</sup> / <sub>16</sub> inch 462 x 308 x 138 mm	5 x 5 = 25	13.0 / 5.90
UFDMP-56	18 <sup>3</sup> / <sub>16</sub> x 14 <sup>1</sup> / <sub>2</sub> x 5 <sup>7</sup> / <sub>16</sub> inch 462 x 369 x 138 mm	5 x 6 = 30	15.4 / 7.00
UFDMP-63	21 <sup>3</sup> / <sub>4</sub> x 7 <sup>5</sup> / <sub>16</sub> x 5 <sup>7</sup> / <sub>16</sub> inch 552 x 186 x 138 mm	6 x 3 = 18	9.7 / 4.42
UFDMP-64	21 <sup>3</sup> / <sub>4</sub> x 9 <sup>3</sup> / <sub>4</sub> x 5 <sup>7</sup> / <sub>16</sub> inch 552 x 247 x 138 mm	6 x 4 = 24	12.6 / 5.73
UFDMP-65	21 <sup>3</sup> / <sub>4</sub> x 12 <sup>1</sup> / <sub>8</sub> x 5 <sup>7</sup> / <sub>16</sub> inch 552 x 308 x 138 mm	6 x 5 = 30	15.5 / 7.05
UFDMP-66	21 <sup>3</sup> / <sub>4</sub> x 14 <sup>1</sup> / <sub>2</sub> x 5 <sup>7</sup> / <sub>16</sub> inch 552 x 369 x 138 mm	6 x 6 = 36	17.9 / 8.14
UFDMP-73	25 <sup>3</sup> / <sub>16</sub> x 7 <sup>5</sup> / <sub>16</sub> x 5 <sup>7</sup> / <sub>16</sub> inch 642 x 186 x 138 mm	7 x 3 = 21	11.0 / 4.97
UFDMP-74	25 <sup>3</sup> / <sub>16</sub> x 9 <sup>3</sup> / <sub>4</sub> x 5 <sup>7</sup> / <sub>16</sub> inch 642 x 247 x 138 mm	7 x 4 = 28	14.2 / 6.43
UFDMP-75	25 <sup>3</sup> / <sub>16</sub> x 12 <sup>1</sup> / <sub>8</sub> x 5 <sup>7</sup> / <sub>16</sub> inch 642 x 308 x 138 mm	7 x 5 = 35	17.4 / 7.91
UFDMP-76	25 <sup>3</sup> / <sub>16</sub> x 14 <sup>1</sup> / <sub>2</sub> x 5 <sup>7</sup> / <sub>16</sub> inch 642 x 369 x 138 mm	7 x 6 = 42	20.7 / 9.38

# Upright Freezer Drawer Rack

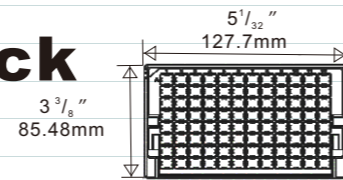

### For Matrix

1.0ml Screw-Top Latch Rack (H=2 1/8 inch / 54.8mm)

### For Micronic

Roborack-96 with High Cover (H=2 1/4 inch / 56.1mm)

### For Fluidx

96-Format Rack for Tube with Protective Jacket with Tall Profile Lid (H=2 3/16 inch / 55mm)

24-Format Rack (H=2 1/4 inch / 56mm)

96-Format Rack for 1.0ml and 1.4ml Tube with Tall Profile Lid (H=2 7/16 inch / 61.8mm)

### For Abgene

1.2ml 2D Barcoded Tube in Stackable Rack (H=2 1/4 inch / 56.13mm)

1.2ml 2D Barcoded Storage Tube Rack (H=2 1/4 inch / 56.13mm)

H: 2 1/8" - 2 7/16" (54.8-61.8mm)

- ◆ Made of corrosion resistant stainless steel.
- ◆ Drawer racks allow easy access to and storage of samples without having to remove the whole rack from the freezer.

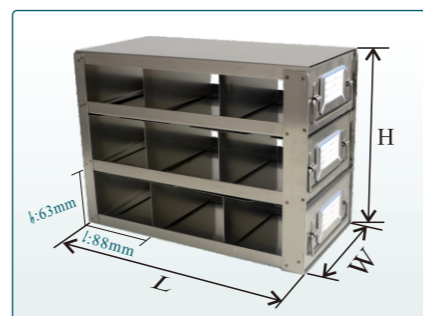

Part Number	Dimension L x H x W	Capacity	Shipping Weight(lb/Kg)
UFDMX-332	10 <sup>7</sup> / <sub>8</sub> x 7 <sup>15</sup> / <sub>16</sub> x 5 <sup>7</sup> / <sub>16</sub> inch 276.5 x 202 x 138 mm	3 x 3 = 9	5.4 / 2.45
UFDMX-342	10 <sup>7</sup> / <sub>8</sub> x 10 <sup>9</sup> / <sub>16</sub> x 5 <sup>7</sup> / <sub>16</sub> inch 276.5 x 268.5 x 138 mm	3 x 4 = 12	7.0 / 3.17
UFDMX-352	10 <sup>7</sup> / <sub>8</sub> x 13 <sup>3</sup> / <sub>16</sub> x 5 <sup>7</sup> / <sub>16</sub> inch 276.5 x 335 x 138 mm	3 x 5 = 15	8.6 / 3.90
UFDMX-432	14 <sup>3</sup> / <sub>8</sub> x 7 <sup>15</sup> / <sub>16</sub> x 5 <sup>7</sup> / <sub>16</sub> inch 365 x 202 x 138 mm	4 x 3 = 12	6.7 / 3.05
UFDMX-442	14 <sup>3</sup> / <sub>8</sub> x 10 <sup>9</sup> / <sub>16</sub> x 5 <sup>7</sup> / <sub>16</sub> inch 365 x 268.5 x 138 mm	4 x 4 = 16	8.7 / 3.95
UFDMX-452	14 <sup>3</sup> / <sub>8</sub> x 13 <sup>3</sup> / <sub>16</sub> x 5 <sup>7</sup> / <sub>16</sub> inch 365 x 335 x 138 mm	4 x 5 = 20	10.7 / 4.86
UFDMX-532	17 <sup>7</sup> / <sub>8</sub> x 7 <sup>15</sup> / <sub>16</sub> x 5 <sup>7</sup> / <sub>16</sub> inch 454 x 202 x 138 mm	5 x 3 = 15	8.1 / 3.68
UFDMX-542	17 <sup>7</sup> / <sub>8</sub> x 10 <sup>9</sup> / <sub>16</sub> x 5 <sup>7</sup> / <sub>16</sub> inch 454 x 268.5 x 138 mm	5 x 4 = 20	10.5 / 4.78
UFDMX-552	17 <sup>7</sup> / <sub>8</sub> x 13 <sup>3</sup> / <sub>16</sub> x 5 <sup>7</sup> / <sub>16</sub> inch 454 x 335 x 138 mm	5 x 5 = 25	12.7 / 5.78
UFDMX-632	21 <sup>3</sup> / <sub>8</sub> x 7 <sup>15</sup> / <sub>16</sub> x 5 <sup>7</sup> / <sub>16</sub> inch 538.5x202x138 mm	6 x 3 = 18	9.6 / 4.34
UFDMX-642	21 <sup>3</sup> / <sub>8</sub> x 10 <sup>9</sup> / <sub>16</sub> x 5 <sup>7</sup> / <sub>16</sub> inch 542.5x268.5x138 mm	6 x 4 = 24	12.4 / 5.62
UFDMX-652	21 <sup>3</sup> / <sub>8</sub> x 13 <sup>3</sup> / <sub>16</sub> x 5 <sup>7</sup> / <sub>16</sub> inch 542.5x335x138 mm	6 x 5 = 30	15.2 / 6.91

# Vertical Rack

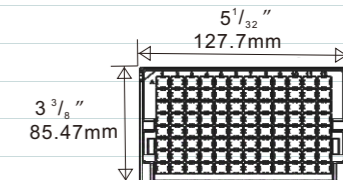

H: 1<sup>5</sup>/<sub>16</sub>" - 1<sup>1</sup>/<sub>8</sub>" (23.8-28.45mm)

### For Matrix

500µl (0.5ml) Latch Rack (H=1<sup>1</sup>/<sub>16</sub> inch / 27.48mm)

### For Micronic

Loborack-96 with Low Cover (H=1<sup>5</sup>/<sub>16</sub> inch / 23.8mm)

### For Fluidx

Low Profile 96-Format Rack for all 0.5ml and 0.75ml Tube with Low Profile Lid (H=1 inch / 26.0mm)

### For Abgene

0.3ml 2D Barcoded Storage Rack (H=1<sup>1</sup>/<sub>8</sub> inch / 28.45mm)

- ◆ Made of corrosion resistant stainless steel.
- ◆ Locking rods are included.

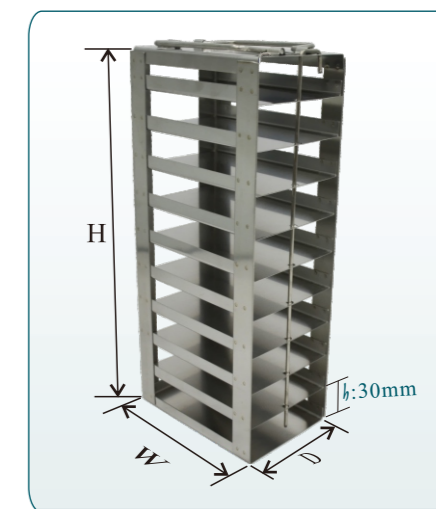

Part Number	Dimension H x D x W	Capacity	Shipping Weight(lb/Kg)
CFMM-10	12 <sup>3</sup> / <sub>8</sub> x 3 <sup>5</sup> / <sub>8</sub> x 5 <sup>1</sup> / <sub>2</sub> inch 315 x 92 x 140 mm	10	2.3 / 1.06
CFMM-11	13 <sup>3</sup> / <sub>8</sub> x 3 <sup>5</sup> / <sub>8</sub> x 5 <sup>1</sup> / <sub>2</sub> inch 345.6 x 92 x 140 mm	11	2.5 / 1.15
CFMM-12	14 <sup>13</sup> / <sub>16</sub> x 3 <sup>5</sup> / <sub>8</sub> x 5 <sup>1</sup> / <sub>2</sub> inch 376.3 x 92 x 140 mm	12	2.7 / 1.24
CFMM-13	16 x 3 <sup>5</sup> / <sub>8</sub> x 5 <sup>1</sup> / <sub>2</sub> inch 407 x 92 x 140 mm	13	2.9 / 1.33
CFMM-14	17 <sup>1</sup> / <sub>4</sub> x 3 <sup>5</sup> / <sub>8</sub> x 5 <sup>1</sup> / <sub>2</sub> inch 437.7 x 92 x 140 mm	14	3.1 / 1.42
CFMM-15	18 <sup>7</sup> / <sub>16</sub> x 3 <sup>5</sup> / <sub>8</sub> x 5 <sup>1</sup> / <sub>2</sub> inch 468.4 x 92 x 140 mm	15	3.3 / 1.51
CFMM-16	19 <sup>5</sup> / <sub>8</sub> x 3 <sup>5</sup> / <sub>8</sub> x 5 <sup>1</sup> / <sub>2</sub> inch 499 x 92 x 140 mm	16	3.5 / 1.61
CFMM-17	20 <sup>7</sup> / <sub>8</sub> x 3 <sup>5</sup> / <sub>8</sub> x 5 <sup>1</sup> / <sub>2</sub> inch 529.8 x 92 x 140 mm	17	3.7 / 1.70
CFMM-18	22 <sup>1</sup> / <sub>16</sub> x 3 <sup>5</sup> / <sub>8</sub> x 5 <sup>1</sup> / <sub>2</sub> inch 560.5 x 92 x 140 mm	18	3.9 / 1.79
CFMM-19	23 <sup>1</sup> / <sub>4</sub> x 3 <sup>5</sup> / <sub>8</sub> x 5 <sup>1</sup> / <sub>2</sub> inch 591.2 x 92 x 140 mm	19	4.1 / 1.88
CFMM-20	24 <sup>1</sup> / <sub>2</sub> x 3 <sup>5</sup> / <sub>8</sub> x 5 <sup>1</sup> / <sub>2</sub> inch 622 x 92 x 140 mm	20	4.3 / 1.97

## Vertical Rack

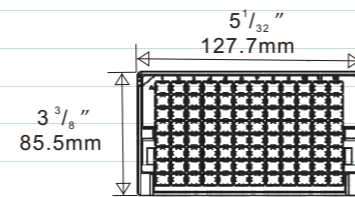

H: 1 1/4" - 1 1/2" (31.7-38.7mm)

### For Micronic

- Loborack-96 with Standard Cover (H=1 1/4 inch / 31.7mm)
- Loborack-96 with High Cover (H=1 1/2 inch / 38.7mm)

### For Fluidx

- Low Profile 96-Format Rack for all 0.5ml and 0.75ml Tube with Standard Profile Lid (H=1 5/16 inch / 32.9mm)
- 96-Format Rack for Tube with Protective Jacket with Low Cover (H=1 1/2 inch / 38mm)

### For Abgene

- 0.5ml 2D Barcoded Lock Storage Tube Rack (H=1 1/2 inch / 38.5mm)
- 0.6ml 2D Barcoded Storage Tube Rack (H=1 1/2 inch / 38.5mm)

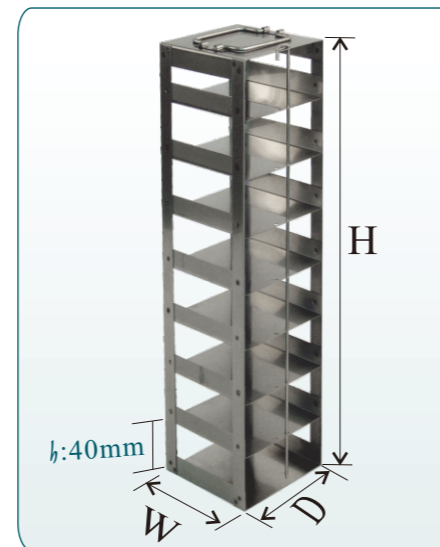

- ◆ Made of corrosion resistant stainless steel.
- ◆ Locking rods are included.

Part Number	Dimension H x D x W	Capacity	Shipping Weight(lb/Kg)
CFML-9	15 1/4 x 3 5/8 x 5 1/2 inch 388 x 92 x 140 mm	9	2.4 / 1.07
CFML-10	16 15/16 x 3 5/8 x 5 1/2 inch 430 x 92 x 140 mm	10	2.6 / 1.17
CFML-11	18 9/16 x 3 5/8 x 5 1/2 inch 472 x 92 x 140 mm	11	2.8 / 1.27
CFML-12	20 1/4 x 3 5/8 x 5 1/2 inch 514.3 x 92 x 140 mm	12	3.0 / 1.37
CFML-13	21 15/16 x 3 5/8 x 5 1/2 inch 557 x 92 x 140 mm	13	3.2 / 1.47
CFML-14	23 9/16 x 3 5/8 x 5 1/2 inch 598.7 x 92 x 140 mm	14	3.4 / 1.56
CFML-15	25 1/4 x 3 5/8 x 5 1/2 inch 641 x 92 x 140 mm	15	3.7 / 1.68
CFML-16	26 7/8 x 3 5/8 x 5 1/2 inch 683 x 92 x 140 mm	16	3.9 / 1.78

## Vertical Rack

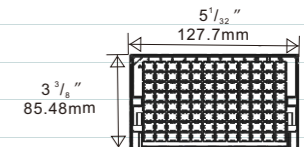

H: 9/16" - 1 3/4" (14.4-44.32mm)

### For Matrix

- 500µl Screw-Top Latch Rack (H=1 3/4 inch / 44.32mm)
- 0.75ml Latch Rack (H=1 1/2 inch / 39.37mm)

### For Micronic

- Roborack-96 with Low Cover (H=1 5/8 inch / 41.2mm)

### For Fluidx

- 384-Format Rack for Square Tube (H=9/16 inch / 14.4mm, each compartment holds 3 racks.)
- Low Profile 96-Format Rack for all 0.5ml and 0.75ml Tube with Tall Profile Lid (H=1 3/4 inch / 43.87mm)
- 96-Format Rack for 1.0ml Tube with Low Profile Lid (H=1 3/4 inch / 43.9mm)
- 96-Format Rack for Tube with Protective Jacket with Standard Profile Lid (H=1 3/4 inch / 44mm)

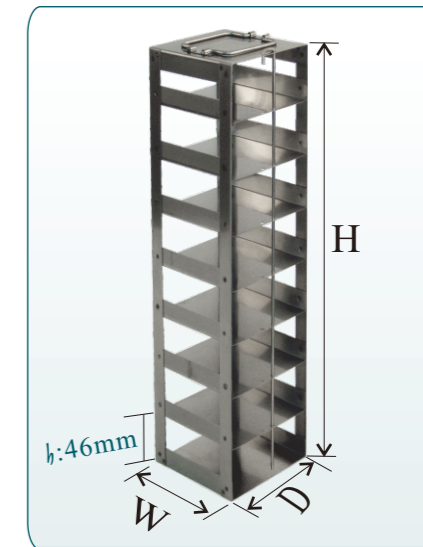

- ◆ Made of corrosion resistant stainless steel.
- ◆ Locking rods are included.

Part Number	Dimension H x D x W	Capacity	Lock Device Option*	Shipping Weight(lb/Kg)
CFDP-9	16 5/8 x 3 5/8 x 5 1/2 inch 423 x 92 x 140 mm	9	DR-15	3.1 / 1.39
CFDP-10	18 7/16 x 3 5/8 x 5 1/2 inch 469 x 92 x 140 mm	10	DR-17	3.3 / 1.48
CFDP-11	20 1/4 x 3 5/8 x 5 1/2 inch 515 x 92 x 140 mm	11	DR-19	3.5 / 1.61
CFDP-12	22 1/8 x 3 5/8 x 5 1/2 inch 562 x 92 x 140 mm	12	DR-22	3.8 / 1.73
CFDP-13	23 15/16 x 3 5/8 x 5 1/2 inch 608 x 92 x 140 mm	13	DR-23	4.1 / 1.86
CFDP-14	25 3/4 x 3 5/8 x 5 1/2 inch 654 x 92 x 140 mm	14	DR-25	4.4 / 1.99
CFDP-15	27 9/16 x 3 5/8 x 5 1/2 inch 700 x 92 x 140 mm	15	DR-27	4.7 / 2.12
CFDP-16	29 7/16 x 3 5/8 x 5 1/2 inch 747 x 92 x 140 mm	16	DR-29	5.0 / 2.25

## Vertical Rack

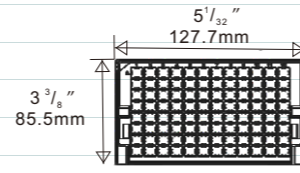

### For Matrix

1.4ml Latch Rack (H=1<sup>15</sup>/<sub>16</sub> inch / 49.84mm)

H: 1<sup>1</sup>/<sub>16</sub> inch - 2<sup>1</sup>/<sub>82</sub> inch (17.3-53.5mm)

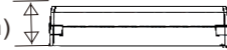

### For Micronic

Roborack-96 with Standard Cover (H=1<sup>15</sup>/<sub>16</sub> inch / 49.1mm)

Comorack-96 (H=2 inch / 52mm)

Comorack-24 (H=2 inch / 52mm)

### For Fluidx

384-Format Rack for Round Tube (H=1<sup>1</sup>/<sub>16</sub> inch / 17.1mm, each compartment holds 3 racks.)

96-Format Rack for 1.0ml and 1.4ml Tube with Standard Profile Lid (H=2 inch / 50.8mm)

48-Format Rack for Cryo Tube with Standard Profile Lid (H=2<sup>1</sup>/<sub>16</sub> inch / 52.8mm)

48-Format Rack for Glass Tube (H=2 inch / 51.6mm)

### For Abgene

2.0ml 2D Barcoded Screw Cap Storage Tube Rack (H=2 inch / 52.5mm)

1.0ml 2D Barcoded Twist Lock Storage Tube Rack (H=2<sup>1</sup>/<sub>8</sub> inch / 53.5mm)

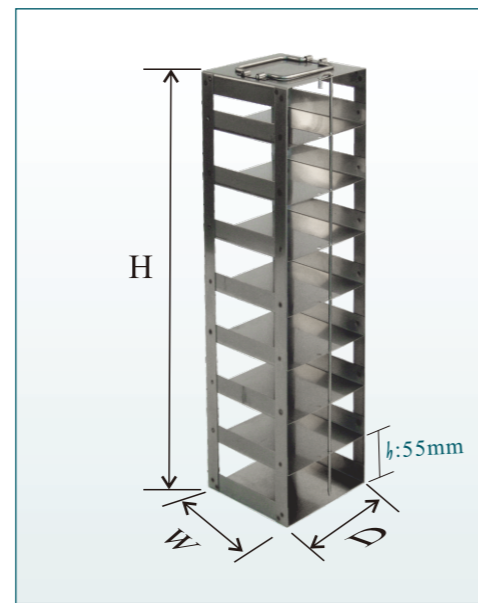

- ◆ Made of corrosion resistant stainless steel.
- ◆ Locking rods are included.

Part Number	Dimension H x D x W	Capacity	Shipping Weight(lb/Kg)
CFTB-8	17 <sup>15</sup> / <sub>16</sub> x 3 <sup>5</sup> / <sub>8</sub> x 5 <sup>1</sup> / <sub>2</sub> inch	455 x 92 x 140 mm	8 2.8 / 1.27
CFTB-9	20 <sup>3</sup> / <sub>16</sub> x 3 <sup>5</sup> / <sub>8</sub> x 5 <sup>1</sup> / <sub>2</sub> inch	512 x 92 x 140 mm	9 3.1 / 1.41
CFTB-10	22 <sup>7</sup> / <sub>8</sub> x 3 <sup>5</sup> / <sub>8</sub> x 5 <sup>1</sup> / <sub>2</sub> inch	568 x 92 x 140 mm	10 3.4 / 1.55
CFTB-11	24 <sup>9</sup> / <sub>16</sub> x 3 <sup>5</sup> / <sub>8</sub> x 5 <sup>1</sup> / <sub>2</sub> inch	624 x 92 x 140 mm	11 3.7 / 1.68
CFTB-12	26 <sup>3</sup> / <sub>4</sub> x 3 <sup>5</sup> / <sub>8</sub> x 5 <sup>1</sup> / <sub>2</sub> inch	680 x 92 x 140 mm	12 4.0 / 1.82
CFTB-13	29 x 3 <sup>5</sup> / <sub>8</sub> x 5 <sup>1</sup> / <sub>2</sub> inch	736 x 92 x 140 mm	13 4.3 / 1.96

## Vertical Rack

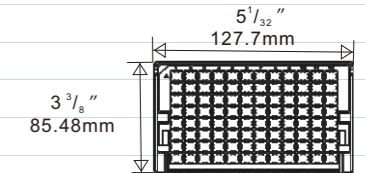

### For Matrix

1.0ml Screw-Top Latch Rack (H=2<sup>3</sup>/<sub>16</sub> inch / 54.8mm)

H: 2<sup>3</sup>/<sub>16</sub> inch - 2<sup>7</sup>/<sub>16</sub> inch (54.8-61.8mm)

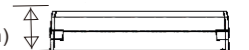

### For Micronic

Roborack-96 with High Cover (H=2<sup>1</sup>/<sub>4</sub> inch / 56.1mm)

### For Fluidx

96-Format Rack for Tube with Protective Jacket with Tall Profile Lid (H=2<sup>3</sup>/<sub>16</sub> inch / 55mm)

24-Format Rack (H=2<sup>1</sup>/<sub>4</sub> inch / 56mm)

96-Format Tube Rack for 1.0ml and 1.4ml Tube with Tall Profile Lid (H=2<sup>7</sup>/<sub>16</sub> inch / 61.8mm)

### For Abgene

1.2ml 2D Barcoded Tube in Stackable Rack (H=2<sup>1</sup>/<sub>4</sub> inch / 56.13mm)

1.2ml 2D Barcoded Storage Tube Rack (H=2<sup>1</sup>/<sub>4</sub> inch / 56.13mm)

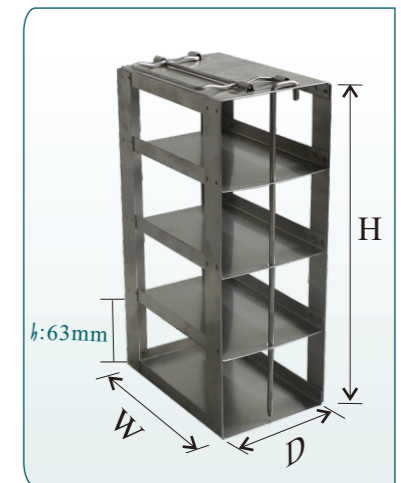

- ◆ Made of corrosion resistant stainless steel.
- ◆ Locking rods are included.

Part Number	Dimension H x D x W	Capacity	Shipping Weight(lb/Kg)
CFMX-4-2	10 <sup>1</sup> / <sub>4</sub> x 3 <sup>5</sup> / <sub>8</sub> x 5 <sup>1</sup> / <sub>2</sub> inch	260 x 92 x 140 mm	4 1.4 / 0.62
CFMX-5-2	12 <sup>1</sup> / <sub>16</sub> x 3 <sup>5</sup> / <sub>8</sub> x 5 <sup>1</sup> / <sub>2</sub> inch	323 x 92 x 140 mm	5 1.6 / 0.74
CFMX-6-2	15 <sup>3</sup> / <sub>16</sub> x 3 <sup>5</sup> / <sub>8</sub> x 5 <sup>1</sup> / <sub>2</sub> inch	386 x 92 x 140 mm	6 1.9 / 0.86
CFMX-7-2	17 <sup>1</sup> / <sub>16</sub> x 3 <sup>5</sup> / <sub>8</sub> x 5 <sup>1</sup> / <sub>2</sub> inch	449 x 92 x 140 mm	7 2.2 / 0.98
CFMX-8-2	20 <sup>3</sup> / <sub>16</sub> x 3 <sup>5</sup> / <sub>8</sub> x 5 <sup>1</sup> / <sub>2</sub> inch	512 x 92 x 140 mm	8 2.4 / 1.10
CFMX-9-2	22 <sup>5</sup> / <sub>8</sub> x 3 <sup>5</sup> / <sub>8</sub> x 5 <sup>1</sup> / <sub>2</sub> inch	575 x 92 x 140 mm	9 2.7 / 1.22
CFMX-10-2	25 <sup>1</sup> / <sub>8</sub> x 3 <sup>5</sup> / <sub>8</sub> x 5 <sup>1</sup> / <sub>2</sub> inch	638 x 92 x 140 mm	10 3.0 / 1.34
CFMX-11-2	27 <sup>3</sup> / <sub>8</sub> x 3 <sup>5</sup> / <sub>8</sub> x 5 <sup>1</sup> / <sub>2</sub> inch	701 x 92 x 140 mm	11 3.2 / 1.46
CFMX-12-2	30 <sup>1</sup> / <sub>16</sub> x 3 <sup>5</sup> / <sub>8</sub> x 5 <sup>1</sup> / <sub>2</sub> inch	764 x 92 x 140 mm	12 3.5 / 1.58
CFMX-13-2	32 <sup>7</sup> / <sub>16</sub> x 3 <sup>5</sup> / <sub>8</sub> x 5 <sup>1</sup> / <sub>2</sub> inch	827 x 92 x 140mm	13 3.7 / 1.70

## Vertical Rack

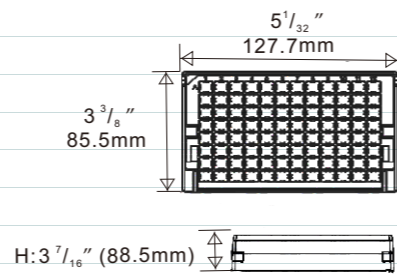

### For Micronic

Roborack-96 with Extra High Cover (H=3 7/16 inch / 88.5mm)

### For Fluidx

48-Format Rack for Cryo Tube with Tall Profile Lid (H=3 7/16 inch / 88.5mm)

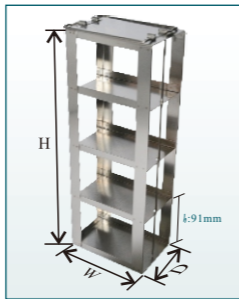

- ◆ Made of corrosion resistant stainless steel.
- ◆ Locking rods are included.

Part Number	Dimension H x D x W	Capacity	Shipping Weight(lb/Kg)
CFMH-4	14 3/4 x 3 3/8 x 5 1/2 inch 374 x 92 x 140 mm	4	1.7 / 0.75
CFMH-5	18 5/16 x 3 3/8 x 5 1/2 inch 465 x 92 x 140 mm	5	2.0 / 0.89
CFMH-6	21 15/16 x 3 3/8 x 5 1/2 inch 557 x 92 x 140 mm	6	2.3 / 1.04
CFMH-7	25 1/2 x 3 3/8 x 5 1/2 inch 648 x 92 x 140 mm	7	2.6 / 1.18
CFMH-8	29 1/8 x 3 3/8 x 5 1/2 inch 740 x 92 x 140 mm	8	2.9 / 1.33
CFMH-9	32 11/16 x 3 3/8 x 5 1/2 inch 831 x 92 x 140 mm	9	3.3 / 1.48

### For Matrix

12ml Screw-Top Latch Rack Boxes (H=4 1/4 inch / 107.82mm)

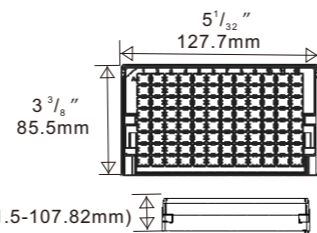

### For Abgene

5.0ml 2D Barcoded Screw Cap Storage Tube Rack (H=4 inch / 101.5mm)

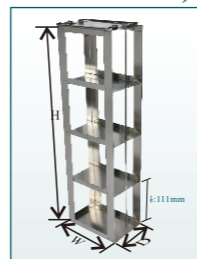

- ◆ Made of corrosion resistant stainless steel.
- ◆ Locking rods are included.

Part Number	Dimension H x D x W	Capacity	Shipping Weight(lb/Kg)
CFMR-4	17 13/16 x 3 3/8 x 5 1/2 inch 453 x 92 x 140 mm	4	1.8 / 0.80
CFMR-5	22 7/16 x 3 3/8 x 5 1/2 inch 564 x 92 x 140 mm	5	2.1 / 0.96
CFMR-6	26 5/8 x 3 3/8 x 5 1/2 inch 676 x 92 x 140 mm	6	2.5 / 1.13
CFMR-7	31 x 3 3/8 x 5 1/2 inch 787 x 92 x 140 mm	7	2.8 / 1.29

## Upright Freezer Rack

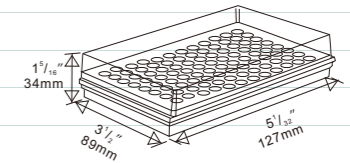

### For 0.2ml Tube 96-Well PCR Boxes

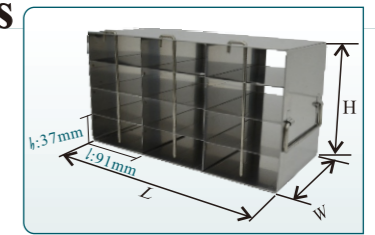

- ◆ Made of corrosion resistant stainless steel.
- ◆ Locking rods are included.

Part Number	Dimension L x H x W	Capacity (Box)	Shipping Weight(lb/Kg)
UFPCR-34L	11 7/16 x 6 1/8 x 5 1/2 inch 293 x 156 x 140 mm	3 x 4 = 12	3.9 / 1.77
UFPCR-35L	11 7/16 x 7 7/8 x 5 1/2 inch 293 x 194 x 140 mm	3 x 5 = 15	4.6 / 2.10
UFPCR-36L	11 7/16 x 9 1/4 x 5 1/2 inch 293 x 231 x 140 mm	3 x 6 = 18	5.4 / 2.43
UFPCR-37L	11 7/16 x 10 9/16 x 5 1/2 inch 293 x 269 x 140 mm	3 x 7 = 21	6.1 / 2.76
UFPCR-38L	11 7/16 x 12 1/16 x 5 1/2 inch 293 x 306 x 140 mm	3 x 8 = 24	6.8 / 3.10
UFPCR-44L	15 5/16 x 6 1/8 x 5 1/2 inch 385 x 156 x 140 mm	4 x 4 = 16	5.0 / 2.29
UFPCR-45L	14 11/16 x 7 7/8 x 5 1/2 inch 385 x 194 x 140 mm	4 x 5 = 20	6.0 / 2.72
UFPCR-46L	14 11/16 x 9 1/8 x 5 1/2 inch 385 x 231 x 140 mm	4 x 6 = 24	7.0 / 3.16
UFPCR-47L	14 11/16 x 10 9/16 x 5 1/2 inch 385 x 269 x 140 mm	4 x 7 = 28	7.9 / 3.59
UFPCR-48L	14 11/16 x 12 1/16 x 5 1/2 inch 385 x 306 x 140 mm	4 x 9 = 32	8.9 / 4.02
UFPCR-54L	18 13/16 x 6 1/8 x 5 1/2 inch 478 x 156 x 140 mm	5 x 4 = 20	6.2 / 2.81
UFPCR-55L	18 13/16 x 7 7/8 x 5 1/2 inch 478 x 194 x 140 mm	5 x 5 = 25	7.4 / 3.35
UFPCR-56L	18 7/8 x 9 1/8 x 5 1/2 inch 478 x 231 x 140 mm	5 x 6 = 30	8.6 / 3.88
UFPCR-57L	18 3/8 x 10 9/16 x 5 1/2 inch 478 x 269 x 140 mm	5 x 7 = 35	9.7 / 4.41
UFPCR-58L	18 3/8 x 12 1/16 x 5 1/2 inch 478 x 306 x 140 mm	5 x 8 = 40	10.9 / 4.95
UFPCR-64L	22 7/2 x 6 6 1/8 x 5 1/2 inch 571 x 156 x 140 mm	6 x 4 = 24	7.4 / 3.34
UFPCR-65L	22 7/2 x 7 7/8 x 5 1/2 inch 571 x 194 x 140 mm	6 x 5 = 30	8.8 / 3.97
UFPCR-66L	22 7/2 x 9 1/8 x 5 1/2 inch 571 x 231 x 140 mm	6 x 6 = 36	10.2 / 4.61
UFPCR-67L	22 7/2 x 10 9/16 x 5 1/2 inch 571 x 269 x 140 mm	6 x 7 = 42	11.6 / 5.24
UFPCR-68L	22 7/2 x 12 1/16 x 5 1/2 inch 571 x 306 x 140 mm	6 x 8 = 48	12.9 / 5.87
UFPCR-74L	26 1/8 x 6 1/8 x 5 1/2 inch 664 x 156 x 140 mm	7 x 4 = 28	8.5 / 3.86
UFPCR-75L	26 1/8 x 7 7/8 x 5 1/2 inch 664 x 194 x 140 mm	7 x 5 = 35	10.1 / 4.60
UFPCR-76L	26 1/8 x 9 1/8 x 5 1/2 inch 664 x 231 x 140 mm	7 x 6 = 42	11.8 / 5.33
UFPCR-77L	26 1/8 x 10 9/16 x 5 1/2 inch 664 x 269 x 140mm	7 x 7 = 49	13.4 / 6.07
UFPCR-78L	26 1/8 x 12 1/16 x 5 1/2 inch 664 x 306 x 140mm	7 x 8 = 56	15.0 / 6.80

## Upright Freezer Drawer Rack

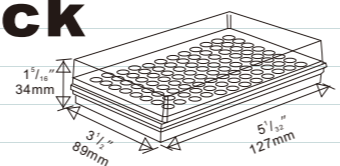

### For 0.2ml Tube 96-Well PCR Boxes

- ◆ Made of corrosion resistant stainless steel.
- ◆ Drawer racks allow easy access to and storage of samples without having to remove the whole rack from the freezer.
- ◆ Each compartment holds two boxes.

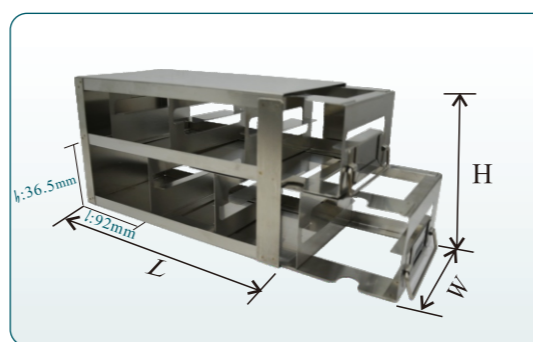

Part Number	Dimension L x H x W	Capacity (Box)	Shipping Weight(lb/Kg)
UFDPCR-32	11 <sup>3</sup> / <sub>8</sub> x 6 <sup>1</sup> / <sub>4</sub> x 5 <sup>7</sup> / <sub>16</sub> inch 289 x 159 x 138 mm	3 x 2 x 2 = 12	4.5 / 2.05
UFDPCR-33	11 <sup>3</sup> / <sub>8</sub> x 9 <sup>3</sup> / <sub>8</sub> x 5 <sup>7</sup> / <sub>16</sub> inch 289 x 238 x 138 mm	3 x 3 x 2 = 18	6.5 / 2.93
UFDPCR-34	11 <sup>3</sup> / <sub>8</sub> x 12 <sup>7</sup> / <sub>16</sub> x 5 <sup>7</sup> / <sub>16</sub> inch 289 x 316 x 138 mm	3 x 4 x 2 = 24	8.4 / 3.82
UFDPCR-42	15 <sup>5</sup> / <sub>16</sub> x 6 <sup>1</sup> / <sub>4</sub> x 5 <sup>7</sup> / <sub>16</sub> inch 382 x 159 x 138 mm	4 x 2 x 2 = 16	5.6 / 2.52
UFDPCR-43	15 <sup>5</sup> / <sub>16</sub> x 9 <sup>3</sup> / <sub>8</sub> x 5 <sup>7</sup> / <sub>16</sub> inch 382 x 238 x 138 mm	4 x 3 x 2 = 24	7.9 / 3.59
UFDPCR-44	15 <sup>5</sup> / <sub>16</sub> x 12 <sup>7</sup> / <sub>16</sub> x 5 <sup>7</sup> / <sub>16</sub> inch 382 x 316 x 138 mm	4 x 4 x 2 = 32	10.3 / 4.68
UFDPCR-52	18 <sup>11</sup> / <sub>16</sub> x 6 <sup>1</sup> / <sub>4</sub> x 5 <sup>7</sup> / <sub>16</sub> inch 474 x 159 x 138 mm	5 x 2 x 2 = 20	6.6 / 2.98
UFDPCR-53	18 <sup>11</sup> / <sub>16</sub> x 9 <sup>3</sup> / <sub>8</sub> x 5 <sup>7</sup> / <sub>16</sub> inch 474 x 238 x 138 mm	5 x 3 x 2 = 30	9.4 / 4.25
UFDPCR-54	18 <sup>11</sup> / <sub>16</sub> x 12 <sup>7</sup> / <sub>16</sub> x 5 <sup>7</sup> / <sub>16</sub> inch 474 x 316 x 138 mm	5 x 4 x 2 = 40	12.2 / 5.54
UFDPCR-62	22 <sup>7</sup> / <sub>16</sub> x 6 <sup>1</sup> / <sub>4</sub> x 5 <sup>7</sup> / <sub>16</sub> inch 561 x 159 x 138 mm	6 x 2 x 2 = 24	7.6 / 3.45
UFDPCR-63	22 <sup>7</sup> / <sub>16</sub> x 9 <sup>3</sup> / <sub>8</sub> x 5 <sup>7</sup> / <sub>16</sub> inch 561 x 238 x 138 mm	6 x 3 x 2 = 36	10.8 / 4.91
UFDPCR-64	22 <sup>7</sup> / <sub>16</sub> x 12 <sup>7</sup> / <sub>16</sub> x 5 <sup>7</sup> / <sub>16</sub> inch 561 x 316 x 138 mm	6 x 4 x 2 = 48	14.1 / 6.39
UFDPCR-72	25 <sup>3</sup> / <sub>4</sub> x 6 <sup>1</sup> / <sub>4</sub> x 5 <sup>7</sup> / <sub>16</sub> inch 654 x 159 x 138 mm	7 x 2 x 2 = 28	8.6 / 3.92
UFDPCR-73	25 <sup>3</sup> / <sub>4</sub> x 9 <sup>3</sup> / <sub>8</sub> x 5 <sup>7</sup> / <sub>16</sub> inch 654 x 238 x 138 mm	7 x 3 x 2 = 42	12.3 / 5.59
UFDPCR-74	25 <sup>3</sup> / <sub>4</sub> x 12 <sup>7</sup> / <sub>16</sub> x 5 <sup>7</sup> / <sub>16</sub> inch 654 x 316 x 138 mm	7 x 4 x 2 = 56	12.5 / 5.67

## Upright Freezer Racks

### For 50-Cell 0.5ml Storage Boxes

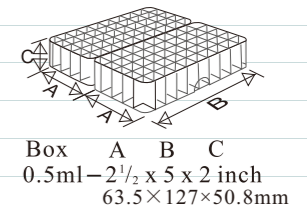

- ◆ Made of corrosion resistant stainless steel.
- ◆ Each rack compartment holds two 50-cell 0.5ml Microtube Storage Boxes.
- ◆ Security lock devices are available for each rack.



w/DP Lock Device Option

\*UFM-1605 / UFM-3605 / UFM-4605 ( h:52.6mm )

Part Number	Dimension L x H x W	Capacity (Box)	Lock Device Option*	Shipping Weight(lb/Kg)
UFM-1305	6 x 6 <sup>3</sup> / <sub>8</sub> x 5 <sup>1</sup> / <sub>2</sub> inch 153 x 169 x 140 mm	1 x 3 x 2 =6	DP-0507	1.8 / 0.83
UFM-1405	6 x 8 <sup>13</sup> / <sub>16</sub> x 5 <sup>1</sup> / <sub>2</sub> inch 153 x 224 x 140 mm	1 x 4 x 2 =8	DP-0509	2.3 / 1.05
UFM-1505	6 x 11 x 5 <sup>1</sup> / <sub>2</sub> inch 153 x 280 x 140 mm	1 x 5 x 2 =10	DP-0511	2.6 / 1.20
UFM-1605	6 x 12 <sup>5</sup> / <sub>8</sub> x 5 <sup>1</sup> / <sub>2</sub> inch 153 x 321 x 140 mm	1 x 6 x 2 =12	DP-0512	3.1 / 1.40
UFM-2305	11 <sup>1</sup> / <sub>2</sub> x 6 <sup>5</sup> / <sub>8</sub> x 5 <sup>1</sup> / <sub>2</sub> inch 292 x 169 x 140 mm	2 x 3 x 2 =12	DP-1107	3.1 / 1.42
UFM-2405	11 <sup>1</sup> / <sub>2</sub> x 8 <sup>13</sup> / <sub>16</sub> x 5 <sup>1</sup> / <sub>2</sub> inch 292 x 224 x 140 mm	2 x 4 x 2 =16	DP-1109	4.0 / 1.80
UFM-2505	11 <sup>1</sup> / <sub>2</sub> x 11 x 5 <sup>1</sup> / <sub>2</sub> inch 292 x 280 x 140 mm	2 x 5 x 2 =20	DP-1111	4.6 / 2.10
UFM-2605	11 <sup>1</sup> / <sub>2</sub> x 12 <sup>5</sup> / <sub>8</sub> x 5 <sup>1</sup> / <sub>2</sub> inch 292 x 321 x 140 mm	2 x 6 x 2 =24	DP-1112	5.5 / 2.48
UFM-3305	16 <sup>15</sup> / <sub>16</sub> x 6 <sup>3</sup> / <sub>8</sub> x 5 <sup>1</sup> / <sub>2</sub> inch 430 x 169 x 140 mm	3 x 3 x 2 =18	DP-1707	4.5 / 2.03
UFM-3405	16 <sup>15</sup> / <sub>16</sub> x 8 <sup>13</sup> / <sub>16</sub> x 5 <sup>1</sup> / <sub>2</sub> inch 430 x 224 x 140 mm	3 x 4 x 2 =24	DP-1709	5.6 / 2.55
UFM-3505	16 <sup>15</sup> / <sub>16</sub> x 11 x 5 <sup>1</sup> / <sub>2</sub> inch 430 x 280 x 140 mm	3 x 5 x 2 =30	DP-1711	6.6 / 2.98
UFM-3605	16 <sup>15</sup> / <sub>16</sub> x 12 <sup>5</sup> / <sub>8</sub> x 5 <sup>1</sup> / <sub>2</sub> inch 430 x 321 x 140 mm	3 x 6 x 2 =36	DP-1712	7.5 / 3.40
UFM-4305	22 <sup>3</sup> / <sub>8</sub> x 6 <sup>5</sup> / <sub>8</sub> x 5 <sup>1</sup> / <sub>2</sub> inch 569 x 169 x 140 mm	4 x 3 x 2 =24	DP-2207	5.8 / 2.64
UFM-4405	22 <sup>3</sup> / <sub>8</sub> x 8 <sup>13</sup> / <sub>16</sub> x 5 <sup>1</sup> / <sub>2</sub> inch 569 x 224 x 140 mm	4 x 4 x 2 =32	DP-2209	7.3 / 3.29
UFM-4505	22 <sup>3</sup> / <sub>8</sub> x 11 x 5 <sup>1</sup> / <sub>2</sub> inch 569 x 280 x 140 mm	4 x 5 x 2 =40	DP-2211	8.6 / 3.88
UFM-4605	22 <sup>3</sup> / <sub>8</sub> x 12 <sup>5</sup> / <sub>8</sub> x 5 <sup>1</sup> / <sub>2</sub> inch 569 x 321 x 140 mm	4 x 6 x 2 =48	DP-2212	9.9 / 4.50

\*Security lock device is ordered separately.



## Chest Freezer Racks

**For 50-Cell 0.5ml Storage Boxes**  
(Locking Rod Included)

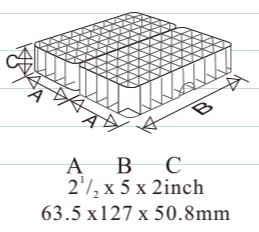

- ◆ Made of corrosion resistant stainless steel.
- ◆ Each rack compartment holds two 50-cell 0.5ml Microtube Storage Boxes.
- ◆ Security lock devices are available for each rack.

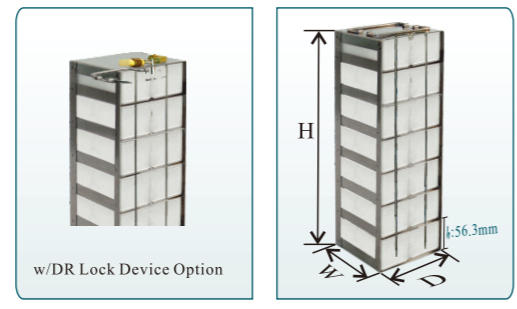

Part Number	Dimension H x D x W	Capacity (Box)	Lock Device Option*	Shipping Weight (lb/Kg)
CFM-305	6 <sup>15</sup> / <sub>16</sub> x 5 <sup>1</sup> / <sub>2</sub> x 5 <sup>1</sup> / <sub>2</sub> inch 176 x 140 x 140 mm	6	DR-06S	1.6 / 0.74
CFM-405	9 <sup>3</sup> / <sub>16</sub> x 5 <sup>1</sup> / <sub>2</sub> x 5 <sup>1</sup> / <sub>2</sub> inch 233 x 140 x 140 mm	8	DR-09S	2.0 / 0.90
CFM-505	11 <sup>7</sup> / <sub>16</sub> x 5 <sup>1</sup> / <sub>2</sub> x 5 <sup>1</sup> / <sub>2</sub> inch 290 x 140 x 140 mm	10	DR-11S	2.4 / 1.07
CFM-605	13 <sup>3</sup> / <sub>8</sub> x 5 <sup>1</sup> / <sub>2</sub> x 5 <sup>1</sup> / <sub>2</sub> inch 346 x 140 x 140 mm	12	DR-12S	2.7 / 1.24
CFM-705	15 <sup>7</sup> / <sub>8</sub> x 5 <sup>1</sup> / <sub>2</sub> x 5 <sup>1</sup> / <sub>2</sub> inch 403 x 140 x 140 mm	14	DR-15S	3.1 / 1.41
CFM-805	18 <sup>1</sup> / <sub>8</sub> x 5 <sup>1</sup> / <sub>2</sub> x 5 <sup>1</sup> / <sub>2</sub> inch 460 x 140 x 140 mm	16	DR-17S	3.5 / 1.58
CFM-905	20 <sup>3</sup> / <sub>8</sub> x 5 <sup>1</sup> / <sub>2</sub> x 5 <sup>1</sup> / <sub>2</sub> inch 517 x 140 x 140 mm	18	DR-19S	3.9 / 1.75
CFM-1005	22 <sup>7</sup> / <sub>8</sub> x 5 <sup>1</sup> / <sub>2</sub> x 5 <sup>1</sup> / <sub>2</sub> inch 574 x 140 x 140 mm	20	DR-22S	4.2 / 1.92
CFM-1105	24 <sup>13</sup> / <sub>16</sub> x 5 <sup>1</sup> / <sub>2</sub> x 5 <sup>1</sup> / <sub>2</sub> inch 630 x 140 x 140 mm	22	DR-23S	4.6 / 2.09
CFM-1205	27 <sup>1</sup> / <sub>16</sub> x 5 <sup>1</sup> / <sub>2</sub> x 5 <sup>1</sup> / <sub>2</sub> inch 687 x 140 x 140 mm	24	DR-26S	4.9 / 2.24
CFM-1305	29 <sup>3</sup> / <sub>16</sub> x 5 <sup>1</sup> / <sub>2</sub> x 5 <sup>1</sup> / <sub>2</sub> inch 744 x 140 x 140 mm	26	DR-29S	5.4 / 2.43

\*Security lock device is ordered separately.

## Upright Freezer Racks

**For 50-Cell 1.5ml Microtube Storage Boxes**

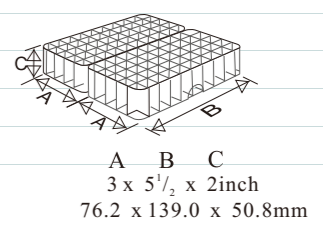

- ◆ Made of corrosion resistant stainless steel.
- ◆ Each rack compartment holds two 50-cell 0.5ml Microtube Storage Boxes.
- ◆ Security lock devices are available for each rack.

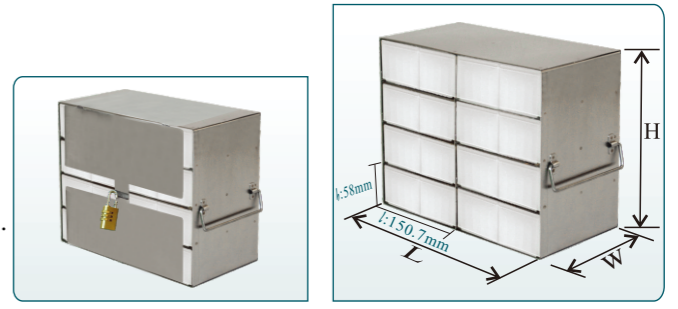

w/DP Lock Device Option

Part Number	Dimension L x H x W	Capacity (Box)	Lock Device Option*	Shipping Weight (lb/Kg)
UFM-1315	6 <sup>3</sup> / <sub>4</sub> x 6 <sup>15</sup> / <sub>16</sub> x 5 <sup>7</sup> / <sub>8</sub> inch 172 x 176 x 149 mm	1 x 3 x 2 =6	DP-0607	2.1 / 0.93
UFM-1415	6 <sup>3</sup> / <sub>4</sub> x 9 <sup>1</sup> / <sub>4</sub> x 5 <sup>7</sup> / <sub>8</sub> inch 172 x 235 x 149 mm	1 x 4 x 2 =8	DP-0609	2.5 / 1.14
UFM-1515	6 <sup>3</sup> / <sub>4</sub> x 11 <sup>9</sup> / <sub>16</sub> x 5 <sup>7</sup> / <sub>8</sub> inch 172 x 293 x 149 mm	1 x 5 x 2 =10	DP-0612	3.0 / 1.36
UFM-2315	13 x 6 <sup>15</sup> / <sub>16</sub> x 5 <sup>7</sup> / <sub>8</sub> inch 330 x 176 x 149 mm	2 x 3 x 2 =12	DP-1307	3.6 / 1.64
UFM-2415	13 x 9 <sup>1</sup> / <sub>4</sub> x 5 <sup>7</sup> / <sub>8</sub> inch 330 x 235 x 149 mm	2 x 4 x 2 =16	DP-1309	4.4 / 2.01
UFM-2515	13 x 11 <sup>9</sup> / <sub>16</sub> x 5 <sup>7</sup> / <sub>8</sub> inch 330 x 293 x 149 mm	2 x 5 x 2 =20	DP-1312	5.3 / 2.39
UFM-2615	13 x 12 <sup>3</sup> / <sub>8</sub> x 5 <sup>7</sup> / <sub>8</sub> inch 330 x 321 x 149 mm	2 x 6 x 2 =24	DP-1313	5.9 / 2.69
UFM-2715	13 x 14 <sup>1</sup> / <sub>4</sub> x 5 <sup>7</sup> / <sub>8</sub> inch 330 x 375 x 149 mm	2 x 7 x 2 =28	DP-1314	6.7 / 3.05
UFM-3315	19 <sup>3</sup> / <sub>16</sub> x 6 <sup>15</sup> / <sub>16</sub> x 5 <sup>7</sup> / <sub>8</sub> inch 488 x 176 x 149 mm	3 x 3 x 2 =18	DP-1907	5.2 / 2.34
UFM-3415	19 <sup>3</sup> / <sub>16</sub> x 9 <sup>1</sup> / <sub>4</sub> x 5 <sup>7</sup> / <sub>8</sub> inch 488 x 235 x 149 mm	3 x 4 x 2 =24	DP-1909	6.3 / 2.88
UFM-3515	19 <sup>3</sup> / <sub>16</sub> x 11 <sup>9</sup> / <sub>16</sub> x 5 <sup>7</sup> / <sub>8</sub> inch 488 x 293 x 149 mm	3 x 5 x 2 =30	DP-1912	7.6 / 3.43
UFM-3615	19 <sup>3</sup> / <sub>16</sub> x 12 <sup>3</sup> / <sub>8</sub> x 5 <sup>7</sup> / <sub>8</sub> inch 488 x 321 x 149 mm	3 x 6 x 2 =36	DP-1913	8.5 / 3.85
UFM-3715	19 <sup>3</sup> / <sub>16</sub> x 14 <sup>1</sup> / <sub>4</sub> x 5 <sup>7</sup> / <sub>8</sub> inch 488 x 375 x 149 mm	3 x 7 x 2 =42	DP-1914	9.7 / 4.38

\*Security lock device is ordered separately.

## Chest Freezer Racks

For 50-Cell 1.5ml Microtube

Storage Boxes

(Locking Rod Included)

- ◆ Made of corrosion resistant stainless steel.
- ◆ Each rack compartment holds two 50-cell 0.5ml Microtube Storage Boxes.
- ◆ Security lock devices are available for each rack.

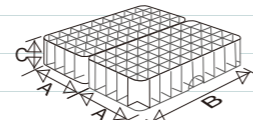

Box A B C

1.5ml – 3 x 5 1/2 x 2 inch  
76.2 x 139 x 50.8mm



w/DR Lock Device Option

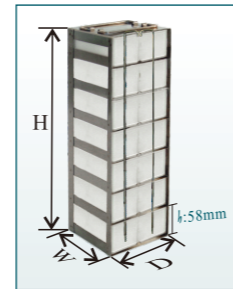

Part Number	Dimension H x D x W	Capacity (Box)	Lock Device Option*	Shipping Weight (lb/Kg)
CFM-315	7 1/8 x 5 7/8 x 6 1/4 inch 181 x 149 x 159 mm	6	DR-06S	2.0 / 0.89
CFM-415	9 7/16 x 5 7/8 x 6 1/4 inch 240 x 149 x 159 mm	8	DR-09S	2.2 / 1.02
CFM-515	11 3/4 x 5 7/8 x 6 1/4 inch 298 x 149 x 159 mm	10	DR-11S	2.6 / 1.19
CFM-615	14 1/16 x 5 7/8 x 6 1/4 inch 357 x 149 x 159 mm	12	DR-12S	3.1 / 1.40
CFM-715	16 5/16 x 5 7/8 x 6 1/4 inch 415 x 149 x 159 mm	14	DR-15S	3.5 / 1.59
CFM-815	18 11/16 x 5 7/8 x 6 1/4 inch 474 x 149 x 159 mm	16	DR-17S	3.9 / 1.78
CFM-915	20 15/16 x 5 7/8 x 6 1/4 inch 532 x 149 x 159 mm	18	DR-19S	4.3 / 1.96
CFM-1015	23 1/4 x 5 7/8 x 6 1/4 inch 591 x 149 x 159 mm	20	DR-22S	4.8 / 2.16
CFM-1115	25 9/16 x 5 7/8 x 6 1/4 inch 649 x 149 x 159 mm	22	DR-25S	5.2 / 2.34
CFM-1215	27 7/8 x 5 7/8 x 6 1/4 inch 708 x 149 x 159 mm	24	DR-27S	5.6 / 2.54
CFM-1315	30 3/16 x 5 7/8 x 6 1/4 inch 766 x 149 x 159 mm	26	DR-29S	6.0 / 2.72

\* Security lock device is ordered separately.

## Upright Freezer Racks

For 96-Well Flipper Reversible Boxes

- ◆ Made of corrosion resistant stainless steel.

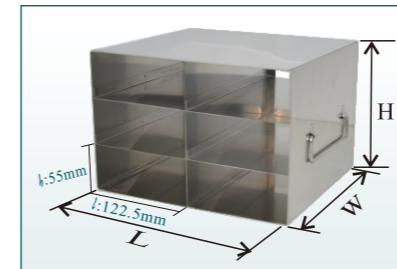
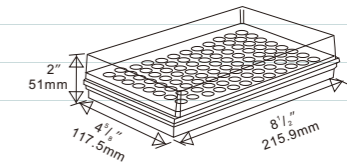

\*UFR-26 / UFR-36 / UFR-46 / UFR-56 (h:52.6mm)

Part Number	Dimension L x H x W	Capacity (Box)	Shipping Weight (lb/Kg)
UFR-22	9 13/16 x 4 7/16 x 8 3/4 inch 261 x 113 x 222 mm	2x2=4	3.3 / 1.51
UFR-23	10 1/4 x 6 5/8 x 8 3/4 inch 261 x 169 x 222 mm	2x3=6	4.4 / 2.00
UFR-24	10 1/4 x 9 3/16 x 8 3/4 inch 261 x 233 x 222 mm	2x4=8	5.6 / 2.52
UFR-25	10 1/4 x 11 x 8 3/4 inch 261 x 280 x 222 mm	2x5=10	6.5 / 2.96
UFR-26	10 1/4 x 12 5/8 x 8 3/4 inch 261 x 321 x 222 mm	2x6=12	7.5 / 3.39
UFR-32	15 5/8 x 4 7/16 x 8 3/4 inch 384 x 113 x 222 mm	3x2=6	4.7 / 2.15
UFR-33	15 5/8 x 6 5/8 x 8 3/4 inch 384 x 169 x 222 mm	3x3=9	6.3 / 2.85
UFR-34	15 5/8 x 9 3/16 x 8 3/4 inch 384 x 233 x 222 mm	3x4=12	7.9 / 3.58
UFR-35	15 5/8 x 11 x 8 3/4 inch 384 x 280 x 222 mm	3x5=15	9.3 / 4.22
UFR-36	15 5/8 x 12 5/8 x 8 3/4 inch 384 x 321 x 222 mm	3x6=18	10.6 / 4.83
UFR-42	19 15/16 x 4 7/16 x 8 3/4 inch 507 x 113 x 222 mm	4x2=8	6.2 / 2.80
UFR-43	19 15/16 x 6 5/8 x 8 3/4 inch 507 x 169 x 222 mm	4x3=12	8.2 / 3.70
UFR-44	19 15/16 x 9 3/16 x 8 3/4 inch 507 x 233 x 222 mm	4x4=16	10.3 / 4.65
UFR-45	19 15/16 x 11 x 8 3/4 inch 507 x 280 x 222 mm	4x5=20	12.1 / 5.49
UFR-46	19 15/16 x 12 5/8 x 8 3/4 inch 507 x 321 x 222 mm	4x6=24	13.8 / 6.28
UFR-52	24 13/16 x 4 7/16 x 8 3/4 inch 630 x 113 x 222 mm	5x2=10	7.6 / 3.45
UFR-53	24 13/16 x 6 5/8 x 8 3/4 inch 630 x 169 x 222 mm	5x3=15	10.0 / 4.55
UFR-54	24 13/16 x 9 3/16 x 8 3/4 inch 630 x 233 x 222 mm	5x4=20	12.6 / 5.72
UFR-55	24 13/16 x 11 x 8 3/4 inch 630 x 280 x 222 mm	5x5=25	14.9 / 6.75
UFR-56	24 13/16 x 12 5/8 x 8 3/4 inch 630 x 321 x 222 mm	5x6=30	17.0 / 7.73

## Upright Freezer Racks

For 32/8 Flipper JR Reversible Multi-Boxes

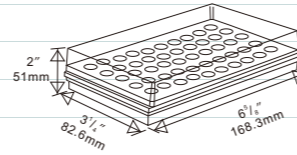

- ◆ Made of corrosion resistant stainless steel.

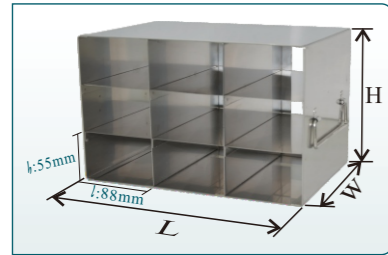

\*\*UFF-36 / UFF-46 / UFF-56 / UFR-66 / UFR-76 ( h:52.5mm )

Part Number	Dimension L x H x W	Capacity (Box)	Shipping Weight(lb/Kg)
UFF-33	11 x 6 <sup>5</sup> / <sub>8</sub> x 6 <sup>15</sup> / <sub>16</sub> inch 280 x 169 x 177 mm	3x3=9	4.3 / 1.94
UFF-34	11 x 9 <sup>3</sup> / <sub>16</sub> x 6 <sup>15</sup> / <sub>16</sub> inch 280 x 233 x 177 mm	3x4=12	5.4 / 2.47
UFF-35	11 x 11 x 6 <sup>15</sup> / <sub>16</sub> inch 280 x 280 x 177 mm	3x5=15	6.4 / 2.91
UFF-36	11 x 12 <sup>5</sup> / <sub>8</sub> x 6 <sup>15</sup> / <sub>16</sub> inch 280 x 321 x 177 mm	3x6=18	7.3 / 3.33
UFF-43	14 <sup>1</sup> / <sub>2</sub> x 6 <sup>5</sup> / <sub>8</sub> x 6 <sup>15</sup> / <sub>16</sub> inch 369 x 169 x 177 mm	4x3=12	5.5 / 2.51
UFF-44	14 <sup>1</sup> / <sub>2</sub> x 9 <sup>3</sup> / <sub>16</sub> x 6 <sup>15</sup> / <sub>16</sub> inch 369 x 233 x 177 mm	4x4=16	7.0 / 3.19
UFF-45	14 <sup>1</sup> / <sub>2</sub> x 11 x 6 <sup>15</sup> / <sub>16</sub> inch 369 x 280 x 177 mm	4x5=20	8.3 / 3.76
UFF-46	14 <sup>1</sup> / <sub>2</sub> x 12 <sup>5</sup> / <sub>8</sub> x 6 <sup>15</sup> / <sub>16</sub> inch 369 x 321 x 177 mm	4x6=24	9.5 / 4.31
UFF-53	18 <sup>1</sup> / <sub>16</sub> x 6 <sup>5</sup> / <sub>8</sub> x 6 <sup>15</sup> / <sub>16</sub> inch 458 x 169 x 177 mm	5x3=15	6.8 / 3.07
UFF-54	18 <sup>1</sup> / <sub>16</sub> x 9 <sup>3</sup> / <sub>16</sub> x 6 <sup>15</sup> / <sub>16</sub> inch 458 x 233 x 177 mm	5x4=20	8.6 / 3.90
UFF-55	18 <sup>1</sup> / <sub>16</sub> x 11 x 6 <sup>15</sup> / <sub>16</sub> inch 458 x 280 x 177 mm	5x5=25	10.2 / 4.61
UFF-56	18 <sup>1</sup> / <sub>16</sub> x 12 <sup>5</sup> / <sub>8</sub> x 6 <sup>15</sup> / <sub>16</sub> inch 458 x 321 x 177 mm	5x6=30	11.6 / 5.28
UFF-63	21 <sup>1</sup> / <sub>2</sub> x 6 <sup>5</sup> / <sub>8</sub> x 6 <sup>15</sup> / <sub>16</sub> inch 546 x 169 x 177 mm	6x3=18	8.0 / 3.64
UFF-64	21 <sup>1</sup> / <sub>2</sub> x 9 <sup>3</sup> / <sub>16</sub> x 6 <sup>15</sup> / <sub>16</sub> inch 546 x 233 x 177 mm	6x4=24	10.2 / 4.62
UFF-65	21 <sup>1</sup> / <sub>2</sub> x 11 x 6 <sup>15</sup> / <sub>16</sub> inch 546 x 280 x 177 mm	6x5=30	12.0 / 5.46
UFF-66	21 <sup>1</sup> / <sub>2</sub> x 12 <sup>5</sup> / <sub>8</sub> x 6 <sup>15</sup> / <sub>16</sub> inch 546 x 321 x 177 mm	6x6=36	13.8 / 6.26
UFF-73	25 x 6 <sup>5</sup> / <sub>8</sub> x 6 <sup>15</sup> / <sub>16</sub> inch 635 x 169 x 177 mm	7x3=21	9.3 / 4.21
UFF-74	25 x 9 <sup>3</sup> / <sub>16</sub> x 6 <sup>15</sup> / <sub>16</sub> inch 635 x 233 x 177 mm	7x4=28	11.8 / 5.34
UFF-75	25 x 11 x 6 <sup>15</sup> / <sub>16</sub> inch 635 x 280 x 177 mm	7x5=35	13.9 / 6.31
UFF-76	25 x 12 <sup>5</sup> / <sub>8</sub> x 6 <sup>15</sup> / <sub>16</sub> inch 635 x 321 x 177 mm	7x6=42	15.9 / 7.23

## Upright Freezer Racks

For 80 - Place Tube Boxes

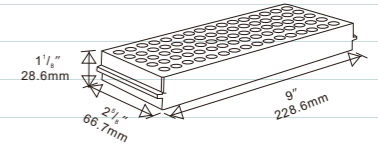

- ◆ Made of corrosion resistant stainless steel.

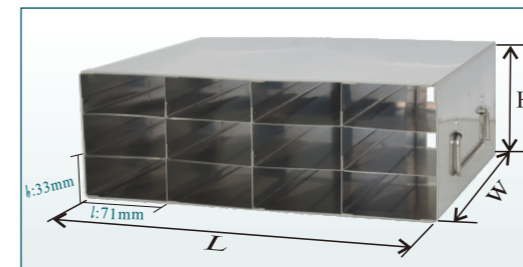

Part Number	Dimension L x H x W	Capacity (Box)	Shipping Weight(lb/Kg)
UT80-43	11 <sup>7</sup> / <sub>8</sub> x 4 <sup>1</sup> / <sub>16</sub> x 9 <sup>3</sup> / <sub>16</sub> inch 301 x 103 x 234 mm	4x3=12	5.4 / 2.43
UT80-44	11 <sup>7</sup> / <sub>8</sub> x 5 <sup>3</sup> / <sub>8</sub> x 9 <sup>3</sup> / <sub>16</sub> inch 301 x 136 x 234 mm	4x4=16	6.7 / 3.02
UT80-45	11 <sup>7</sup> / <sub>8</sub> x 6 <sup>11</sup> / <sub>16</sub> x 9 <sup>3</sup> / <sub>16</sub> inch 301 x 170 x 234 mm	4x5=20	8.0 / 3.62
UT80-46	11 <sup>7</sup> / <sub>8</sub> x 8 x 9 <sup>3</sup> / <sub>16</sub> inch 301 x 203 x 234 mm	4x6=24	9.3 / 4.21
UT80-53	14 <sup>11</sup> / <sub>16</sub> x 4 <sup>1</sup> / <sub>16</sub> x 9 <sup>3</sup> / <sub>16</sub> inch 373 x 103 x 234 mm	5x3=15	6.6 / 2.99
UT80-54	14 <sup>11</sup> / <sub>16</sub> x 5 <sup>3</sup> / <sub>8</sub> x 9 <sup>3</sup> / <sub>16</sub> inch 373 x 136 x 234 mm	5x4=20	8.2 / 3.72
UT80-55	14 <sup>11</sup> / <sub>16</sub> x 6 <sup>11</sup> / <sub>16</sub> x 9 <sup>3</sup> / <sub>16</sub> inch 373 x 170 x 234 mm	5x5=25	9.8 / 4.45
UT80-56	14 <sup>11</sup> / <sub>16</sub> x 8 x 9 <sup>3</sup> / <sub>16</sub> inch 373 x 203 x 234 mm	5x6=30	11.4 / 5.17
UT80-63	17 <sup>1</sup> / <sub>2</sub> x 4 <sup>1</sup> / <sub>16</sub> x 9 <sup>3</sup> / <sub>16</sub> inch 444 x 103 x 234 mm	6x3=18	7.8 / 3.54
UT80-64	17 <sup>1</sup> / <sub>2</sub> x 5 <sup>3</sup> / <sub>8</sub> x 9 <sup>3</sup> / <sub>16</sub> inch 444 x 136 x 234 mm	6x4=24	9.7 / 4.41
UT80-65	17 <sup>1</sup> / <sub>2</sub> x 6 <sup>11</sup> / <sub>16</sub> x 9 <sup>3</sup> / <sub>16</sub> inch 444 x 170 x 234 mm	6x5=30	11.6 / 5.27
UT80-66	17 <sup>1</sup> / <sub>2</sub> x 8 x 9 <sup>3</sup> / <sub>16</sub> inch 444 x 203 x 234 mm	6x6=36	13.5 / 6.14
UT80-73	20 <sup>5</sup> / <sub>16</sub> x 4 <sup>1</sup> / <sub>16</sub> x 9 <sup>3</sup> / <sub>16</sub> inch 516 x 104 x 234 mm	7x3=21	9.0 / 4.10
UT80-74	20 <sup>5</sup> / <sub>16</sub> x 5 <sup>3</sup> / <sub>8</sub> x 9 <sup>3</sup> / <sub>16</sub> inch 516 x 136 x 234 mm	7x4=28	11.2 / 5.10
UT80-75	20 <sup>5</sup> / <sub>16</sub> x 6 <sup>11</sup> / <sub>16</sub> x 9 <sup>3</sup> / <sub>16</sub> inch 516 x 170 x 234 mm	7x5=35	13.4 / 6.10
UT80-76	20 <sup>5</sup> / <sub>16</sub> x 8 x 9 <sup>3</sup> / <sub>16</sub> inch 516 x 203 x 234 mm	7x6=42	15.7 / 7.10
UT80-83	23 <sup>1</sup> / <sub>8</sub> x 4 <sup>1</sup> / <sub>16</sub> x 9 <sup>3</sup> / <sub>16</sub> inch 588 x 103 x 234 mm	8x3=24	10.3 / 4.65
UT80-84	23 <sup>1</sup> / <sub>8</sub> x 5 <sup>3</sup> / <sub>8</sub> x 9 <sup>3</sup> / <sub>16</sub> inch 588 x 136 x 234 mm	8x4=32	12.8 / 5.79
UT80-85	23 <sup>1</sup> / <sub>8</sub> x 6 <sup>11</sup> / <sub>16</sub> x 9 <sup>3</sup> / <sub>16</sub> inch 588 x 170 x 234 mm	8x5=40	15.3 / 6.93
UT80-86	23 <sup>1</sup> / <sub>8</sub> x 8 x 9 <sup>3</sup> / <sub>16</sub> inch 588 x 203 x 234 mm	8x6=48	17.8 / 8.07

## Upright Freezer Racks

### For Plasma Boxes

- ◆ Made of corrosion resistant stainless steel.

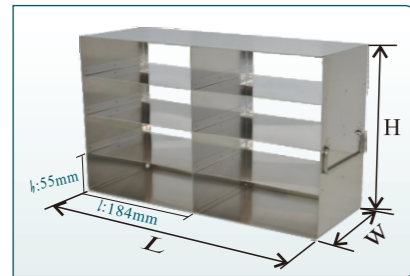

\*UFP-16 / UFP-26 / UFP-36 ( h:52.5 )

Part Number	Dimension L x H x W	Capacity (Box)	Shipping Weight(lb/Kg)
UFP-13	7 <sup>13</sup> / <sub>16</sub> x 6 <sup>5</sup> / <sub>8</sub> x 5 <sup>1</sup> / <sub>2</sub> inch 199 x 168 x 140 mm	1x3=3	2.1 / 0.94
UFP-14	7 <sup>13</sup> / <sub>16</sub> x 8 <sup>13</sup> / <sub>16</sub> x 5 <sup>1</sup> / <sub>2</sub> inch 199 x 224 x 140 mm	1x4=4	2.6 / 1.17
UFP-15	7 <sup>13</sup> / <sub>16</sub> x 11 x 5 <sup>1</sup> / <sub>2</sub> inch 199 x 280 x 140 mm	1x5=5	3.0 / 1.37
UFP-16	7 <sup>13</sup> / <sub>16</sub> x 12 <sup>5</sup> / <sub>8</sub> x 5 <sup>1</sup> / <sub>2</sub> inch 199 x 321 x 140 mm	1x6=6	3.4 / 1.55
UFP-23	15 <sup>1</sup> / <sub>8</sub> x 6 <sup>5</sup> / <sub>8</sub> x 5 <sup>1</sup> / <sub>2</sub> inch 384 x 168 x 140 mm	2x3=6	3.7 / 1.68
UFP-24	15 <sup>1</sup> / <sub>8</sub> x 8 <sup>13</sup> / <sub>16</sub> x 5 <sup>1</sup> / <sub>2</sub> inch 384 x 224 x 140 mm	2x4=8	4.6 / 2.08
UFP-25	15 <sup>1</sup> / <sub>8</sub> x 11 x 5 <sup>1</sup> / <sub>2</sub> inch 384 x 280 x 140 mm	2x5=10	5.4 / 2.43
UFP-26	15 <sup>1</sup> / <sub>8</sub> x 12 <sup>5</sup> / <sub>8</sub> x 5 <sup>1</sup> / <sub>2</sub> inch 384 x 321 x 140 mm	2x6=12	6.1 / 2.77
UFP-33	22 <sup>3</sup> / <sub>8</sub> x 6 <sup>5</sup> / <sub>8</sub> x 5 <sup>1</sup> / <sub>2</sub> inch 568 x 168 x 140 mm	3x3=9	5.3 / 2.41
UFP-34	22 <sup>3</sup> / <sub>8</sub> x 8 <sup>13</sup> / <sub>16</sub> x 5 <sup>1</sup> / <sub>2</sub> inch 568 x 224 x 140 mm	3x4=12	6.8 / 3.08
UFP-35	22 <sup>3</sup> / <sub>8</sub> x 11 x 5 <sup>1</sup> / <sub>2</sub> inch 568 x 280 x 140 mm	3x5=15	8.0 / 3.65
UFP-36	22 <sup>3</sup> / <sub>8</sub> x 12 <sup>5</sup> / <sub>8</sub> x 5 <sup>1</sup> / <sub>2</sub> inch 568 x 321 x 140 mm	3x6=18	9.2 / 4.18

## Upright Freezer Racks

### For 25-Place Slide Boxes

- ◆ Made of corrosion resistant stainless steel.
- ◆ Security lock devices are available for each rack.

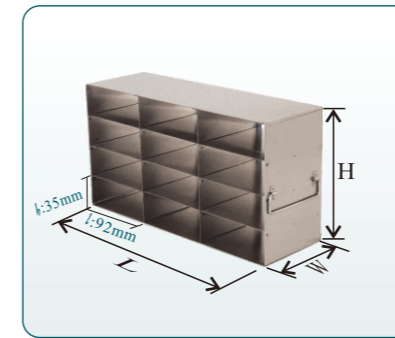

Part Number	Dimension L x H x W	Capacity	Lock Device Option*	Shipping Weight(lb/Kg)
UFS-25-34	295.5 x 156.5 x 145 mm 11 <sup>5</sup> / <sub>8</sub> x 6 <sup>3</sup> / <sub>16</sub> x 5 <sup>11</sup> / <sub>16</sub> inch	12	DP25-1006	4.0 / 1.83
UFS-25-44	389 x 156.5 x 145 mm 15 <sup>5</sup> / <sub>16</sub> x 6 <sup>3</sup> / <sub>16</sub> x 5 <sup>11</sup> / <sub>16</sub> inch	16	DP25-1406	5.2 / 2.35
UFS-25-54	483 x 156.5 x 145 mm 19 x 6 <sup>3</sup> / <sub>16</sub> x 5 <sup>11</sup> / <sub>16</sub> inch	20	DP25-1806	6.4 / 2.92
UFS-25-64	576.5 x 156.5 x 145 mm 22 <sup>11</sup> / <sub>16</sub> x 6 <sup>3</sup> / <sub>16</sub> x 5 <sup>11</sup> / <sub>16</sub> inch	24	DP25-2106	7.7 / 3.47
UFS-25-74	670 x 156.5 x 145 mm 26 <sup>3</sup> / <sub>8</sub> x 6 <sup>3</sup> / <sub>16</sub> x 5 <sup>11</sup> / <sub>16</sub> inch	28	DP25-2506	8.8 / 4.00
UFS-25-35	295.5 x 195 x 145 mm 11 <sup>5</sup> / <sub>8</sub> x 7 <sup>11</sup> / <sub>16</sub> x 5 <sup>11</sup> / <sub>16</sub> inch	15	DP25-1008	4.8 / 2.16
UFS-25-45	389 x 195 x 145 mm 15 <sup>5</sup> / <sub>16</sub> x 7 <sup>11</sup> / <sub>16</sub> x 5 <sup>11</sup> / <sub>16</sub> inch	20	DP25-1408	6.2 / 2.82
UFS-25-55	483 x 195 x 145 mm 19 x 7 <sup>11</sup> / <sub>16</sub> x 5 <sup>11</sup> / <sub>16</sub> inch	25	DP25-1808	7.7 / 3.50
UFS-25-65	576.5 x 195 x 145 mm 22 <sup>11</sup> / <sub>16</sub> x 7 <sup>11</sup> / <sub>16</sub> x 5 <sup>11</sup> / <sub>16</sub> inch	30	DP25-2108	9.1 / 4.12
UFS-25-75	670 x 195 x 145 mm 26 <sup>3</sup> / <sub>8</sub> x 7 <sup>11</sup> / <sub>16</sub> x 5 <sup>11</sup> / <sub>16</sub> inch	35	DP25-2508	10.4 / 4.74
UFS-25-36	295.5 x 233.5 x 145 mm 11 <sup>5</sup> / <sub>8</sub> x 9 <sup>3</sup> / <sub>16</sub> x 5 <sup>11</sup> / <sub>16</sub> inch	18	DP25-1009	5.6 / 2.52
UFS-25-46	389 x 233.5 x 145 mm 15 <sup>5</sup> / <sub>16</sub> x 9 <sup>3</sup> / <sub>16</sub> x 5 <sup>11</sup> / <sub>16</sub> inch	24	DP25-1409	7.2 / 3.28
UFS-25-56	483 x 233.5 x 145 mm 19 x 9 <sup>3</sup> / <sub>16</sub> x 5 <sup>11</sup> / <sub>16</sub> inch	30	DP25-1809	8.9 / 4.03
UFS-25-66	576.5 x 233.5 x 145 mm 22 <sup>11</sup> / <sub>16</sub> x 9 <sup>3</sup> / <sub>16</sub> x 5 <sup>11</sup> / <sub>16</sub> inch	36	DP25-2109	10.6 / 4.80
UFS-25-76	670 x 233.5 x 145 mm 26 <sup>3</sup> / <sub>8</sub> x 9 <sup>3</sup> / <sub>16</sub> x 5 <sup>11</sup> / <sub>16</sub> inch	42	DP25-2509	12.2 / 5.53
UFS-25-37	295.5 x 272 x 145 mm 11 <sup>5</sup> / <sub>8</sub> x 10 <sup>11</sup> / <sub>16</sub> x 5 <sup>11</sup> / <sub>16</sub> inch	21	DP25-1011	6.3 / 2.87
UFS-25-47	389 x 272 x 145 mm 15 <sup>5</sup> / <sub>16</sub> x 10 <sup>11</sup> / <sub>16</sub> x 5 <sup>11</sup> / <sub>16</sub> inch	28	DP25-1411	8.2 / 3.72
UFS-25-57	483 x 272 x 145 mm 19 x 10 <sup>11</sup> / <sub>16</sub> x 5 <sup>11</sup> / <sub>16</sub> inch	35	DP25-1811	10.1 / 4.57
UFS-25-67	576.5 x 272 x 145 mm 22 <sup>11</sup> / <sub>16</sub> x 10 <sup>11</sup> / <sub>16</sub> x 5 <sup>11</sup> / <sub>16</sub> inch	42	DP25-2111	12.0 / 5.43
UFS-25-77	670 x 272 x 145 mm 26 <sup>3</sup> / <sub>8</sub> x 10 <sup>11</sup> / <sub>16</sub> x 5 <sup>11</sup> / <sub>16</sub> inch	49	DP25-2511	13.9 / 6.29
UFS-25-38	295.5 x 310.5 x 145 mm 11 <sup>5</sup> / <sub>8</sub> x 12 <sup>1</sup> / <sub>4</sub> x 5 <sup>11</sup> / <sub>16</sub> inch	24	DP25-1012	7.1 / 3.24
UFS-25-48	389 x 310.5 x 145 mm 15 <sup>5</sup> / <sub>16</sub> x 12 <sup>1</sup> / <sub>5</sub> x 5 <sup>7</sup> / <sub>10</sub> inch	32	DP25-1412	9.3 / 4.20
UFS-25-58	483 x 310.5 x 145 mm 19 x 12 <sup>1</sup> / <sub>5</sub> x 5 <sup>7</sup> / <sub>10</sub> inch	40	DP25-1812	11.4 / 5.17
UFS-25-68	576.5 x 310.5 x 145 mm 22 <sup>11</sup> / <sub>16</sub> x 12 <sup>1</sup> / <sub>5</sub> x 5 <sup>7</sup> / <sub>10</sub> inch	48	DP25-2112	13.5 / 6.14
UFS-25-78	670 x 310.5 x 145 mm 26 <sup>3</sup> / <sub>8</sub> x 12 <sup>1</sup> / <sub>5</sub> x 5 <sup>7</sup> / <sub>10</sub> inch	56	DP25-2512	15.7 / 7.12

\*Security lock device is ordered separately.

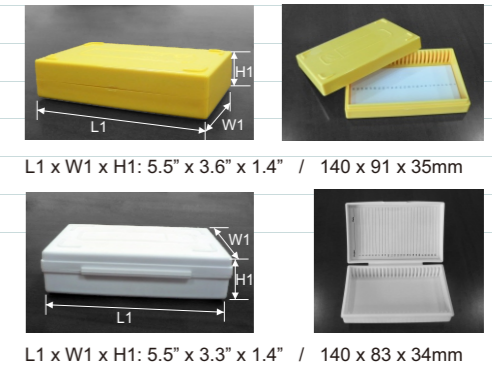

## Upright Freezer Drawer Rack

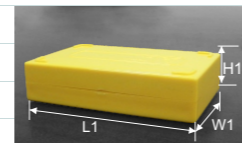

L1 x W1 x H1: 5.5" x 3.6" x 1.4"  
140 x 91 x 35mm

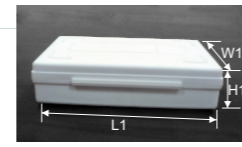

L1 x W1 x H1: 5.5" x 3.3" x 1.4"  
140 x 83 x 34mm

### For 25-Place Slide Boxes

- ◆ Made of corrosion resistant stainless steel.
- ◆ Drawer racks allow easy access to and storage of samples without having to remove the whole rack from the freezer.
- ◆ Security lock devices are available for each rack.

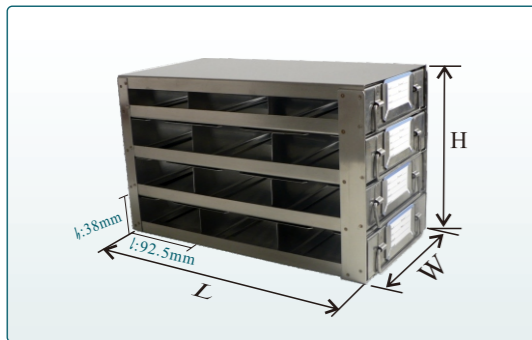

Part Number	Dimension L x H x W	Capacity	Lock Device Option*	Shipping Weight(lb/Kg)	
UFDS-25-34	11 <sup>1</sup> / <sub>2</sub> x 6 <sup>7</sup> / <sub>8</sub> x 6 inch	291.5 x 175 x 152 mm	12	DD25-06	6.6 / 3.00
UFDS-25-44	15 <sup>5</sup> / <sub>16</sub> x 6 <sup>7</sup> / <sub>8</sub> x 6 inch	385 x 175 x 152 mm	16	DD25-06	8.4 / 3.81
UFDS-25-54	18 <sup>7</sup> / <sub>8</sub> x 6 <sup>7</sup> / <sub>8</sub> x 6 inch	479 x 175 x 152 mm	20	DD25-06	10.2 / 4.61
UFDS-25-64	22 <sup>9</sup> / <sub>16</sub> x 6 <sup>7</sup> / <sub>8</sub> x 6 inch	572.5 x 175 x 152 mm	24	DD25-06	12.1 / 5.51
UFDS-25-74	26 <sup>1</sup> / <sub>4</sub> x 6 <sup>7</sup> / <sub>8</sub> x 6 inch	666 x 175 x 152 mm	28	DD25-06	13.9 / 6.30
UFDS-25-35	11 <sup>1</sup> / <sub>2</sub> x 8 <sup>9</sup> / <sub>16</sub> x 6 inch	291.5 x 218 x 152 mm	15	DD25-08	7.9 / 3.60
UFDS-25-45	15 <sup>5</sup> / <sub>16</sub> x 8 <sup>9</sup> / <sub>16</sub> x 6 inch	385 x 218 x 152 mm	20	DD25-08	10.4 / 4.70
UFDS-25-55	18 <sup>7</sup> / <sub>8</sub> x 8 <sup>9</sup> / <sub>16</sub> x 6 inch	479 x 218 x 152 mm	25	DD25-08	12.6 / 5.70
UFDS-25-65	22 <sup>9</sup> / <sub>16</sub> x 8 <sup>9</sup> / <sub>16</sub> x 6 inch	572.5 x 218 x 152 mm	30	DD25-08	14.9 / 6.76
UFDS-25-75	26 <sup>1</sup> / <sub>4</sub> x 8 <sup>9</sup> / <sub>16</sub> x 6 inch	666 x 218 x 152 mm	35	DD25-08	17.1 / 7.74
UFDS-25-36	11 <sup>1</sup> / <sub>2</sub> x 10 <sup>3</sup> / <sub>16</sub> x 6 inch	291.5 x 259 x 152 mm	18	DD25-09	9.4 / 4.27
UFDS-25-46	15 <sup>5</sup> / <sub>16</sub> x 10 <sup>3</sup> / <sub>16</sub> x 6 inch	385 x 259 x 152 mm	24	DD25-09	12.2 / 5.54
UFDS-25-56	18 <sup>7</sup> / <sub>8</sub> x 10 <sup>3</sup> / <sub>16</sub> x 6 inch	479 x 259 x 152 mm	30	DD25-09	14.9 / 6.74
UFDS-25-66	22 <sup>9</sup> / <sub>16</sub> x 10 <sup>3</sup> / <sub>16</sub> x 6 inch	572.5 x 259 x 152 mm	36	DD25-09	17.6 / 8.00
UFDS-25-76	26 <sup>1</sup> / <sub>4</sub> x 10 <sup>3</sup> / <sub>16</sub> x 6 inch	666 x 259 x 152 mm	42	DD25-09	20.2 / 9.16
UFDS-25-37	11 <sup>1</sup> / <sub>2</sub> x 12 x 6 inch	291.5 x 304.5 x 152 mm	21	DD25-11	11.2 / 5.06
UFDS-25-47	15 <sup>5</sup> / <sub>16</sub> x 12 x 6 inch	385 x 304.5 x 152 mm	28	DD25-11	14.1 / 6.40
UFDS-25-57	18 <sup>7</sup> / <sub>8</sub> x 12 x 6 inch	479 x 304.5 x 152 mm	35	DD25-11	17.2 / 7.80
UFDS-25-67	22 <sup>9</sup> / <sub>16</sub> x 12 x 6 inch	572.5 x 304.5 x 152 mm	42	DD25-11	20.4 / 9.24
UFDS-25-77	26 <sup>1</sup> / <sub>4</sub> x 12 x 6 inch	666 x 304.5 x 152 mm	49	DD25-11	23.4 / 10.60
UFDS-25-38	11 <sup>1</sup> / <sub>2</sub> x 13 <sup>11</sup> / <sub>16</sub> x 6 inch	291.5 x 347.5 x 152 mm	24	DD25-13	12.7 / 5.74
UFDS-25-48	15 <sup>5</sup> / <sub>16</sub> x 13 <sup>11</sup> / <sub>16</sub> x 6 inch	385 x 347.5 x 152 mm	32	DD25-13	16.0 / 7.24
UFDS-25-58	18 <sup>7</sup> / <sub>8</sub> x 13 <sup>11</sup> / <sub>16</sub> x 6 inch	479 x 347.5 x 152 mm	40	DD25-13	19.5 / 8.83
UFDS-25-68	22 <sup>9</sup> / <sub>16</sub> x 13 <sup>11</sup> / <sub>16</sub> x 6 inch	572.5 x 347.5 x 152 mm	48	DD25-13	23.1 / 10.50
UFDS-25-78	26 <sup>1</sup> / <sub>4</sub> x 13 <sup>11</sup> / <sub>16</sub> x 6 inch	666 x 347.5 x 152 mm	56	DD25-13	26.5 / 12.00

\*Security lock device is ordered separately.

## Chest Freezer Racks

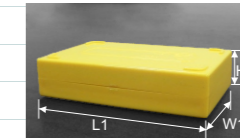

L1 x W1 x H1: 5.5" x 3.6" x 1.4" / 140 x 91 x 35mm

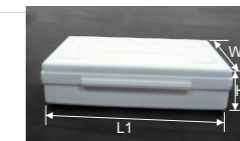

L1 x W1 x H1: 5.5" x 3.3" x 1.4" / 140 x 83 x 34mm



### For 25-Place Slide Boxes

- ◆ Made of corrosion resistant stainless steel.
- ◆ Locking rods are included.
- ◆ Security lock devices are available for each rack.

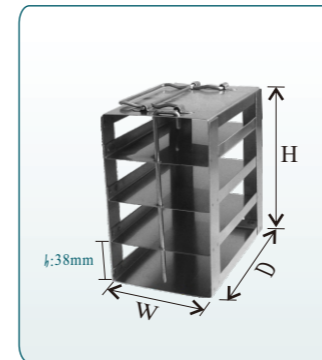

Part Number	Dimension H x D x W	Capacity	Lock Device Option*	Shipping Weight(lb/Kg)	
CFS-25-4	6 <sup>3</sup> / <sub>8</sub> x 6 x 3 <sup>13</sup> / <sub>16</sub> inch	162 x 152 x 97 mm	4	DR25-06	1.4 / 0.62
CFS-25-6	9 <sup>7</sup> / <sub>16</sub> x 6 x 3 <sup>13</sup> / <sub>16</sub> inch	239 x 152 x 97 mm	6	DR25-09	1.8 / 0.82
CFS-25-8	12 <sup>7</sup> / <sub>16</sub> x 6 x 3 <sup>13</sup> / <sub>16</sub> inch	316 x 152 x 97 mm	8	DR25-12	2.3 / 1.03
CFS-25-10	15 <sup>1</sup> / <sub>2</sub> x 6 x 3 <sup>13</sup> / <sub>16</sub> inch	393 x 152 x 97 mm	10	DR25-15	2.7 / 1.23
CFS-25-12	18 <sup>1</sup> / <sub>2</sub> x 6 x 3 <sup>13</sup> / <sub>16</sub> inch	470 x 152 x 97 mm	12	DR25-18	3.2 / 1.45
CFS-25-14	21 <sup>3</sup> / <sub>16</sub> x 6 x 3 <sup>13</sup> / <sub>16</sub> inch	547 x 152 x 97 mm	14	DR25-21	3.7 / 1.66
CFS-25-16	24 <sup>9</sup> / <sub>16</sub> x 6 x 3 <sup>13</sup> / <sub>16</sub> inch	624 x 152 x 97 mm	16	DR25-24	4.1 / 1.87
CFS-25-18	27 <sup>5</sup> / <sub>8</sub> x 6 x 3 <sup>13</sup> / <sub>16</sub> inch	701 x 152 x 97 mm	18	DR25-27	4.6 / 2.07
CFS-25-20	30 <sup>5</sup> / <sub>8</sub> x 6 x 3 <sup>13</sup> / <sub>16</sub> inch	778 x 152 x 97 mm	20	DR25-30	5.0 / 2.28

\*Security lock device is ordered separately.

# Upright Freezer Racks

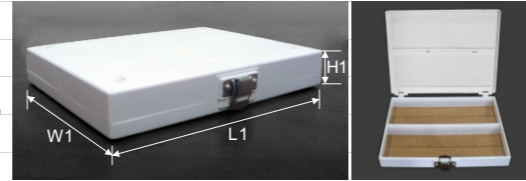

L1 x W1 x H1: 8.25" x 7.0" x 1.34"  
210 x 178 x 34mm

## For 100-Place Slide Boxes

- ◆ Made of corrosion resistant stainless steel.
- ◆ Security lock devices are available for each rack.



Part Number	Dimension L x H x W		Capacity	Lock Device Option*	Shipping Weight(lb/Kg)
UFS-100-24	377.5 x 159 x 213 mm	14 <sup>7</sup> / <sub>8</sub> x 6 <sup>1</sup> / <sub>4</sub> x 8 <sup>3</sup> / <sub>8</sub> inch	8	DP100-1306	5.5 / 2.50
UFS-100-34	559.5 x 159 x 213 mm	22 <sup>1</sup> / <sub>16</sub> x 6 <sup>1</sup> / <sub>4</sub> x 8 <sup>3</sup> / <sub>8</sub> inch	12	DP100-2106	7.9 / 3.60
UFS-100-44	741 x 159 x 213 mm	29 <sup>13</sup> / <sub>16</sub> x 6 <sup>1</sup> / <sub>4</sub> x 8 <sup>3</sup> / <sub>8</sub> inch	16	DP100-2806	8.8 / 4.00
UFS-100-25	377.5 x 198 x 213 mm	14 <sup>7</sup> / <sub>8</sub> x 7 <sup>13</sup> / <sub>16</sub> x 8 <sup>3</sup> / <sub>8</sub> inch	10	DP100-1308	6.7 / 3.04
UFS-100-35	559.5 x 198 x 213 mm	22 <sup>1</sup> / <sub>16</sub> x 7 <sup>13</sup> / <sub>16</sub> x 8 <sup>3</sup> / <sub>8</sub> inch	15	DP100-2108	9.5 / 4.32
UFS-100-45	741 x 198 x 213 mm	29 <sup>13</sup> / <sub>16</sub> x 7 <sup>13</sup> / <sub>16</sub> x 8 <sup>3</sup> / <sub>8</sub> inch	20	DP100-2808	12.6 / 5.70
UFS-100-26	377.5 x 237 x 213 mm	14 <sup>7</sup> / <sub>8</sub> x 9 <sup>5</sup> / <sub>16</sub> x 8 <sup>3</sup> / <sub>8</sub> inch	12	DP100-1309	7.4 / 3.34
UFS-100-36	559.5 x 237 x 213mm	22 <sup>1</sup> / <sub>16</sub> x 9 <sup>5</sup> / <sub>16</sub> x 8 <sup>3</sup> / <sub>8</sub> inch	18	DP100-2109	10.6 / 4.83
UFS-100-46	741 x 237 x 213 mm	29 <sup>13</sup> / <sub>16</sub> x 9 <sup>5</sup> / <sub>16</sub> x 8 <sup>3</sup> / <sub>8</sub> inch	24	DP100-2809	13.9 / 6.30
UFS-100-27	377.5 x 276 x 213 mm	14 <sup>7</sup> / <sub>8</sub> x 10 <sup>7</sup> / <sub>8</sub> x 8 <sup>3</sup> / <sub>8</sub> inch	14	DP100-1311	8.2 / 3.72
UFS-100-37	559.5 x 276 x 213 mm	22 <sup>1</sup> / <sub>16</sub> x 10 <sup>7</sup> / <sub>8</sub> x 8 <sup>3</sup> / <sub>8</sub> inch	21	DP100-2111	11.8 / 5.35
UFS-100-47	741 x 276 x 213 mm	29 <sup>13</sup> / <sub>16</sub> x 10 <sup>7</sup> / <sub>8</sub> x 8 <sup>3</sup> / <sub>8</sub> inch	28	DP100-2811	15.5 / 7.02
UFS-100-28	377.5 x 315 x 213 mm	14 <sup>7</sup> / <sub>8</sub> x 12 <sup>3</sup> / <sub>8</sub> x 8 <sup>3</sup> / <sub>8</sub> inch	16	DP100-1312	9.2 / 4.19
UFS-100-38	559.5 x 315 x 213 mm	22 <sup>1</sup> / <sub>16</sub> x 12 <sup>3</sup> / <sub>8</sub> x 8 <sup>3</sup> / <sub>8</sub> inch	24	DP100-2112	13.5 / 6.13
UFS-100-48	741 x 315 x 213 mm	29 <sup>13</sup> / <sub>16</sub> x 12 <sup>3</sup> / <sub>8</sub> x 8 <sup>3</sup> / <sub>8</sub> inch	32	DP100-2812	17.5 / 7.94

\*Security lock device is ordered separately.

# Upright Freezer Drawer Racks

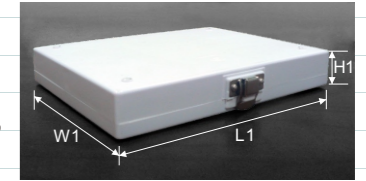

L1 x W1 x H1: 8.25" x 7.0" x 1.34"  
210 x 178 x 34mm

## For 100-Place Slide Boxes

- ◆ Made of corrosion resistant stainless steel.
- ◆ Drawer racks allow easy access to and storage of samples without having to remove the whole rack from the freezer.
- ◆ Security lock devices are available for each rack.

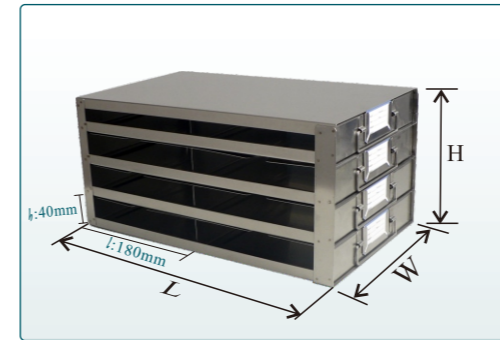

Part Number	Dimension L x H x W		Capacity	Lock Device Option*	Shipping Weight(lb/Kg)
UFDS-100-24	378 x 176.5 x 219 mm	14 <sup>7</sup> / <sub>8</sub> x 6 <sup>15</sup> / <sub>16</sub> x 8 <sup>5</sup> / <sub>8</sub> inch	8	DD100-06	9.1 / 4.12
UFDS-100-34	563.5 x 176.5 x 219 mm	22 <sup>1</sup> / <sub>16</sub> x 6 <sup>15</sup> / <sub>16</sub> x 8 <sup>5</sup> / <sub>8</sub> inch	12	DD100-06	12.8 / 5.80
UFDS-100-44	745 x 176.5 x 219 mm	29 <sup>5</sup> / <sub>16</sub> x 6 <sup>15</sup> / <sub>16</sub> x 8 <sup>5</sup> / <sub>8</sub> inch	16	DD100-06	16.2 / 7.35
UFDS-100-25	382 x 220 x 219 mm	15 <sup>1</sup> / <sub>16</sub> x 8 <sup>11</sup> / <sub>16</sub> x 8 <sup>5</sup> / <sub>8</sub> inch	10	DD100-08	11.4 / 5.18
UFDS-100-35	563.5 x 220 x 219 mm	22 <sup>3</sup> / <sub>16</sub> x 8 <sup>11</sup> / <sub>16</sub> x 8 <sup>5</sup> / <sub>8</sub> inch	15	DD100-08	16.1 / 7.30
UFDS-100-45	745 x 220 x 219 mm	29 <sup>5</sup> / <sub>16</sub> x 8 <sup>11</sup> / <sub>16</sub> x 8 <sup>5</sup> / <sub>8</sub> inch	20	DD100-08	20.5 / 9.20
UFDS-100-26	382 x 263.5 x 219 mm	15 <sup>1</sup> / <sub>16</sub> x 10 <sup>3</sup> / <sub>8</sub> x 8 <sup>5</sup> / <sub>8</sub> inch	12	DD100-09	13.1 / 5.92
UFDS-100-36	563.5 x 263.5 x 219 mm	22 <sup>3</sup> / <sub>16</sub> x 10 <sup>3</sup> / <sub>8</sub> x 8 <sup>5</sup> / <sub>8</sub> inch	18	DD100-09	18.4 / 8.34
UFDS-100-46	745 x 263.5 x 219 mm	29 <sup>5</sup> / <sub>16</sub> x 10 <sup>3</sup> / <sub>8</sub> x 8 <sup>5</sup> / <sub>8</sub> inch	24	DD100-09	23.6 / 10.55
UFDS-100-27	382 x 307 x 219 mm	15 <sup>1</sup> / <sub>16</sub> x 12 <sup>1</sup> / <sub>16</sub> x 8 <sup>5</sup> / <sub>8</sub> inch	14	DD100-11	14.7 / 6.65
UFDS-100-37	563.5 x 307 x 219 mm	22 <sup>3</sup> / <sub>16</sub> x 12 <sup>1</sup> / <sub>16</sub> x 8 <sup>5</sup> / <sub>8</sub> inch	21	DD100-11	20.7 / 9.40
UFDS-100-47	745 x 307 x 219 mm	29 <sup>5</sup> / <sub>16</sub> x 12 <sup>1</sup> / <sub>16</sub> x 8 <sup>5</sup> / <sub>8</sub> inch	28	DD100-11	26.1 / 11.85
UFDS-100-28	382 x 351 x 219 mm	15 <sup>1</sup> / <sub>16</sub> x 13 <sup>13</sup> / <sub>16</sub> x 8 <sup>5</sup> / <sub>8</sub> inch	16	DD100-13	17.1 / 7.74
UFDS-100-38	563.5 x 351 x 219 mm	22 <sup>3</sup> / <sub>16</sub> x 13 <sup>13</sup> / <sub>16</sub> x 8 <sup>5</sup> / <sub>8</sub> inch	24	DD100-13	24.0 / 10.90
UFDS-100-48	745 x 351 x 219 mm	29 <sup>5</sup> / <sub>16</sub> x 13 <sup>13</sup> / <sub>16</sub> x 8 <sup>5</sup> / <sub>8</sub> inch	32	DD100-13	30.4 / 13.80

\*Security lock device is ordered separately.

## Chest Freezer Racks

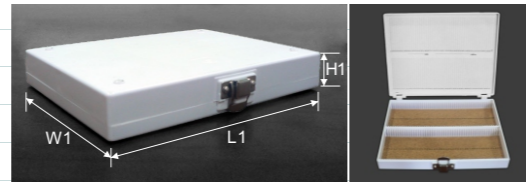

L1 x W1 x H1: 8.25" x 7.0" x 1.34"  
210 x 178 x 34mm

### For 100-Place Slide Boxes

- ◆ Made of corrosion resistant stainless steel.
- ◆ Locking rods are included.
- ◆ Security lock devices are available for each rack.

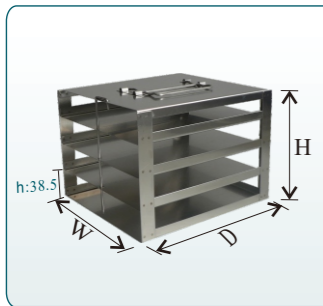

Part Number	Dimension H x D x W		Capacity	Lock Device Option*	Shipping Weight(lb/kg)
CFS-100-4	164 x 220 x 185 mm	6 <sup>7</sup> / <sub>16</sub> x 8 <sup>11</sup> / <sub>16</sub> x 7 <sup>5</sup> / <sub>16</sub> inch	4	DR25-06	2.7 / 1.21
CFS-100-6	242 x 220 x 185 mm	9 <sup>1</sup> / <sub>2</sub> x 8 <sup>11</sup> / <sub>16</sub> x 7 <sup>5</sup> / <sub>16</sub> inch	6	DR25-09	3.7 / 1.68
CFS-100-8	320 x 220 x 185 mm	12 <sup>7</sup> / <sub>8</sub> x 8 <sup>11</sup> / <sub>16</sub> x 7 <sup>5</sup> / <sub>16</sub> inch	8	DR25-12	4.6 / 2.10
CFS-100-10	398 x 220 x 185 mm	15 <sup>11</sup> / <sub>16</sub> x 8 <sup>11</sup> / <sub>16</sub> x 7 <sup>5</sup> / <sub>16</sub> inch	10	DR25-15	5.5 / 2.50
CFS-100-12	476 x 220 x 185 mm	18 <sup>3</sup> / <sub>4</sub> x 8 <sup>11</sup> / <sub>16</sub> x 7 <sup>5</sup> / <sub>16</sub> inch	12	DR25-18	6.5 / 2.96
CFS-100-14	554 x 220 x 185 mm	21 <sup>13</sup> / <sub>16</sub> x 8 <sup>11</sup> / <sub>16</sub> x 7 <sup>5</sup> / <sub>16</sub> inch	14	DR25-21	7.5 / 3.40
CFS-100-16	632 x 220 x 185 mm	24 <sup>7</sup> / <sub>8</sub> x 8 <sup>11</sup> / <sub>16</sub> x 7 <sup>5</sup> / <sub>16</sub> inch	16	DR25-24	8.4 / 3.80
CFS-100-18	710 x 220 x 185 mm	27 <sup>5</sup> / <sub>16</sub> x 8 <sup>11</sup> / <sub>16</sub> x 7 <sup>5</sup> / <sub>16</sub> inch	18	DR25-27	9.3 / 4.20
CFS-100-20	788 x 220 x 185 mm	31 x 8 <sup>11</sup> / <sub>16</sub> x 7 <sup>5</sup> / <sub>16</sub> inch	20	DR25-30	10.4 / 4.70

\*Security lock device is ordered separately.

(Continued from last page)

## Boxes, Cell Dividers, Label Cards

### Cardboard Boxes



Part Number	Description	Color	Dimension L x W x H
SB2CC	White or yellow water repellant cardboard boxes for storage of samples or tubes are supplied with or without cell dividers. Standard boxes have 4 drain holes in each corner.	White	5 <sup>1</sup> / <sub>4</sub> x 5 <sup>1</sup> / <sub>4</sub> x 2 inch 133 x 133 x 51 mm
SB2CC-XX*			5 <sup>5</sup> / <sub>16</sub> x 5 <sup>5</sup> / <sub>16</sub> x 1 <sup>15</sup> / <sub>16</sub> inch 134.8 x 134.8 x 48.8 mm
SB2CC-LP		Yellow	5 <sup>1</sup> / <sub>4</sub> x 5 <sup>1</sup> / <sub>4</sub> x 2 inch 133 x 133 x 51 mm
SB2CC-XX-LP			5 <sup>1</sup> / <sub>4</sub> x 5 <sup>1</sup> / <sub>4</sub> x 2 inch 133 x 133 x 51 mm
SB2C	Hold up to repeated freezing & thawing. Water proof fiberboard. Hinged lid. With 81-place. 3 colors optional.	White	5 <sup>1</sup> / <sub>4</sub> x 5 <sup>1</sup> / <sub>4</sub> x 2 inch 133 x 133 x 51 mm
SB2C-XX*		Purple	
SB2CC-H-81		Green	
SB2CC-H-81-P-W	Large 3" yellow water repellant freezer boxes.	White	5 <sup>3</sup> / <sub>4</sub> x 5 <sup>3</sup> / <sub>4</sub> x 3 inch 133 x 133 x 75 mm
SB2CC-H-81-G-W			
SB3C	White or yellow water repellant cardboard boxes for storage of samples or tubes are supplied with or without cell dividers. Standard boxes have 4 drain holes in each corner.	White	5 <sup>1</sup> / <sub>4</sub> x 5 <sup>1</sup> / <sub>4</sub> x 3 <sup>7</sup> / <sub>8</sub> inch 133 x 133 x 98mm
SB3-75C			
SB3.75C-XX**	White water repellant cardboard boxes for 15ml or 50ml centrifuge tubes are supplied with or without cell dividers. Boxes have 4 drain holes in each corner.	White	5 <sup>13</sup> / <sub>16</sub> x 5 <sup>13</sup> / <sub>16</sub> x 4 <sup>15</sup> / <sub>16</sub> inch 148 x 148 x 125 mm
SB4C			
SB4C-XXX**			
SB10C	Extra large yellow water repellant freezer boxes.	Yellow	10 <sup>11</sup> / <sub>16</sub> x 5 <sup>3</sup> / <sub>16</sub> x 8 <sup>5</sup> / <sub>16</sub> inch 271.5 x 132.5 x 211.5 mm
BB3C	Yellow water repellant cardboard boxes for storage of samples or tubes are supplied with or without of samples or tubes are supplied with or without cell dividers. Standard boxes have 4 drain holes in each corner.	Yellow	5 <sup>3</sup> / <sub>4</sub> x 5 <sup>3</sup> / <sub>4</sub> x 3 inch 146 x 146 x 76 mm
BB3C-100	Large 3" yellow water repellant freezer boxes with 100 cell divider include.		
MB2C	White water repellant mini-cardboard boxes for storage of samples or tubes are supplied with or without 25-cell dividers. Mini Boxes have drain slots.	White	3 x 3 x 2 inch 75 x 75 x 51 mm
MB2C-25			
MB3C		White	3 x 3 x 3 inch 75 x 75 x 76 mm
MB3C-25			

\* To order, replace XX with 100, 81, 64, 49, 36, 25 or 16 for cell dividers.

\*\*To order, replace XXX with 16 or 36 for cell dividers.

\*\*\*w<sup>†</sup>=0.22lb(0.1kg) for cardboard box, 0.37lb(0.17kg) for plastic box, 0.84lb(0.38kg) for stainless steel box, 0.53lb(0.24kg) for aluminum box.

# Boxes, Cell Dividers, Label Cards

## Standard Box Dividers

Standard cardboard cell dividers (CD-XX) fit all 2" and 3" standard cardboard and metal boxes. Dividers for 4" centrifuge tube boxes (CD4-XX) and mini box (MCD-25) are also available.

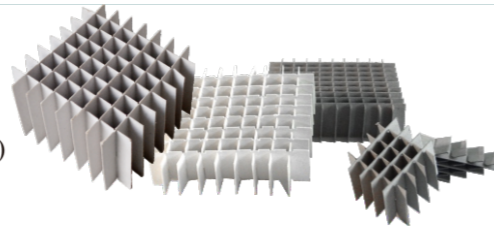

Part Number	Cell Number	Dimension L x D x H	Cell Opening
CD-169	169	4 <sup>7</sup> / <sub>8</sub> x 4 <sup>7</sup> / <sub>8</sub> x 1 <sup>5</sup> / <sub>16</sub> inch 123.4 x 123.4 x 33 mm	<sup>3</sup> / <sub>8</sub> inch (8.74mm)
CD-144	144		<sup>3</sup> / <sub>8</sub> inch (9.52mm)
CD-100	100		<sup>7</sup> / <sub>16</sub> inch (11.5mm)
CD-96	96	7 x 4 <sup>11</sup> / <sub>16</sub> x 1 <sup>1</sup> / <sub>2</sub> inch 178 x 118.4 x 38 mm	<sup>9</sup> / <sub>16</sub> inch (14mm)
CD-81	81	4 <sup>7</sup> / <sub>8</sub> x 4 <sup>7</sup> / <sub>8</sub> x 1 <sup>5</sup> / <sub>16</sub> inch 123.4 x 123.4 x 33 mm	<sup>1</sup> / <sub>2</sub> inch (12.7mm)
CD-64	64		<sup>9</sup> / <sub>16</sub> inch (14.6mm)
CD-49	49		<sup>11</sup> / <sub>16</sub> inch (16.7mm)
CD-36	36		<sup>13</sup> / <sub>16</sub> inch (20mm)
CD-25	25		<sup>15</sup> / <sub>16</sub> inch (24.5mm)
CD-16	16		1 <sup>3</sup> / <sub>16</sub> inch (30.2mm)
CD4-16	16		5 <sup>7</sup> / <sub>16</sub> x 5 <sup>7</sup> / <sub>16</sub> x 2 <sup>3</sup> / <sub>4</sub> inch 138 x 138 x 70 mm
CD4-36	36	<sup>7</sup> / <sub>8</sub> inch (22.25mm)	
CD4-64	64	<sup>5</sup> / <sub>8</sub> inch (16.45mm)	
CD-49-W	49	4 <sup>7</sup> / <sub>8</sub> x 4 <sup>7</sup> / <sub>8</sub> x 1 <sup>1</sup> / <sub>2</sub> inch 124.3 x 124.3 x 31.5 mm	<sup>11</sup> / <sub>16</sub> inch (17mm)
CD-81-W	81	4 <sup>7</sup> / <sub>8</sub> x 4 <sup>7</sup> / <sub>8</sub> x 1 <sup>5</sup> / <sub>16</sub> inch 124.5 x 124.5 x 33 mm	<sup>7</sup> / <sub>16</sub> inch (11.5mm)
CD-100-W	100		<sup>1</sup> / <sub>2</sub> inch (12.7mm)
MCD-25	25	2 <sup>11</sup> / <sub>16</sub> x 2 <sup>11</sup> / <sub>16</sub> x 1 <sup>5</sup> / <sub>16</sub> inch 67.6 x 67.6 x 33 mm	<sup>1</sup> / <sub>2</sub> inch (12.8mm)

(Continued on next page)

# Boxes, Cell Dividers, Label Cards

## Polycarbonate Boxes

Polycarbonate 81 or 100 cell 2" boxes hold most popular cryo and cold storage vials and fit into standard freezer racks. Boxes have clear lids with locator grids to facilitate sample identification. Polycarbonate boxes are designed to withstand temperature extremes of -196°C to 121°C. Boxes have drain holes for venting and safety. Keyed lid prevents misalignment of grid.

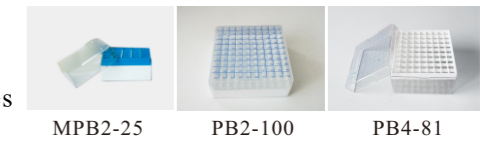

Part Number	Description	Dimension L x D x H	Cell Opening
PB2-100	100	5 <sup>1</sup> / <sub>4</sub> x 5 <sup>1</sup> / <sub>4</sub> x 2 <sup>1</sup> / <sub>16</sub> inch 133 x 133 x 52 mm	<sup>1</sup> / <sub>2</sub> inch (12.5 mm)
PB2-81	81	5 <sup>1</sup> / <sub>4</sub> x 5 <sup>1</sup> / <sub>4</sub> x 2 <sup>1</sup> / <sub>16</sub> inch 133 x 133 x 52 mm	<sup>1</sup> / <sub>2</sub> inch (13 mm)
PB4-81	81	5 <sup>1</sup> / <sub>4</sub> x 5 <sup>1</sup> / <sub>4</sub> x 3 <sup>11</sup> / <sub>16</sub> inch 133 x 133 x 94 mm	<sup>1</sup> / <sub>2</sub> inch (13 mm)
MPB2-25	25	3 x 3 x 2 <sup>1</sup> / <sub>16</sub> inch 76 x 76 x 53 mm	<sup>3</sup> / <sub>8</sub> inch (12.8 mm)

## Polypropylene Boxes

Polypropylene 81 or 100 cell 2" boxes hold most popular cryo and cold storage vials and fit into standard freezer racks. These boxes offer a convenient and cost effective alternative to polycarbonate boxes for storage of samples. Boxes have clear lids with locator grids to facilitate sample identification. Polypropylene boxes are designed to withstand temperature down to -80°C. Storage of polypropylene boxes in liquid nitrogen is not recommended. Boxes have drain holes for venting and safety. Keyed lid prevents misalignment of grid.

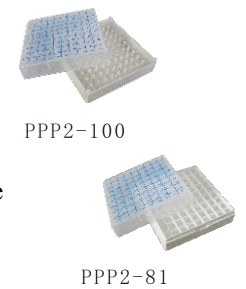

Part Number	Cell Number	Dimension L x D x H	Cell Opening
PPP2-100	100	5 <sup>1</sup> / <sub>4</sub> x 5 <sup>1</sup> / <sub>4</sub> x 2 inch 133 x 133 x 51 mm	<sup>7</sup> / <sub>16</sub> inch (10.5 mm)
PPP2-81	81	5 <sup>1</sup> / <sub>4</sub> x 5 <sup>1</sup> / <sub>4</sub> x 2 inch 133 x 133 x 51 mm	<sup>1</sup> / <sub>2</sub> inch (12.5 mm)

## 100-Cell Hinged Plastic Boxes

100-cell hinged top plastic boxes made of polypropylene offer an alternative storage system for all microtubes up to 2.0 ml and standard 1.2 ml cryovials. The grid is alpha-numerically matrixed with 1-10 and A-J characters hot stamped directly onto the grid for fast, easy sample identification. Boxes fit into standard freezer racks and are available in natural and five different colors.



Part Number	Cell Number	Dimension L x D x H	Cell Opening
PP2-100	100	5 <sup>9</sup> / <sub>16</sub> x 6 x 2 <sup>1</sup> / <sub>8</sub> inch 141 x 152 x 54mm	<sup>1</sup> / <sub>2</sub> inch (12.5 mm)
PP2-100-A			
PP2-100X*			

\* Specify Color: B (Blue), G (Green), O (Orange), P (Pink), or Y (Yellow).

\*\* ω=0.221lb(0.1kg) for cardboard box, 0.371lb(0.17kg) for plastic box, 0.841lb(0.38kg) for stainless steel box, 0.531lb(0.24kg) for aluminum box.

(Continued on next page)



## Boxes, Cell Dividers, Label Cards

### Metal Boxes - Stainless steel

Stainless steel boxes come with or without cardboard dividers and fit into standard freezer racks.

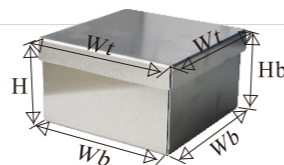

Part Number	Description	Dimension Wt x Wt x H	Dimension Wb x Wb x Hb
SB2S	Standard 2" Box with Drain Hole	5 1/4 x 5 1/4 x 2 inch 133 x 133 x 51 mm	5 x 5 x 1 15/16 inch 127.7 x 127.7 x 49 mm
SB2S-XX*	Standard 2" Box w/Cell Divider & Drain Hole		
SB3S	Standard 3" Box with Drain Hole	5 1/4 x 5 1/4 x 3 inch 133 x 133 x 75 mm	5 x 5 x 2 15/16 inch 127.7 x 127.7 x 74 mm
SB3S-XX*	Standard 3" Box w/Cell Divider & Drain Hole		

\* To order, replace XX with 144,100,81,64,49,36,25 or 16 for cell dividers.

ω<sup>1</sup>=0.221b(0.1kg) for cardboard box, 0.371b(0.17kg) for plastic box, 0.841b(0.38kg) for stainless steel box, 0.531b(0.24kg) for aluminum box.

### Metal Boxes - Aluminum

Aluminum boxes come with or without cardboard dividers and fit into standard freezer racks.

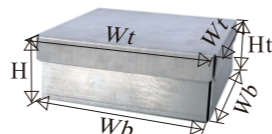

Part Number	Description	Dimension Wt x Wt x H	Dimension Wb x Wb x Hb
SB2A	Standard 2" Box with Drain Hole	5 1/4 x 5 1/4 x 2 inch 133 x 133 x 51 mm	5 x 5 x 1 15/16 inch 127.7 x 127.7 x 49 mm
SB2A-XX*	Standard 2" Box w/Cell Divider & Drain Hole		
SB3A	Standard 3" Box with Drain Hole	5 1/4 x 5 1/4 x 3 inch 133 x 133 x 75 mm	5 x 5 x 2 15/16 inch 127.7 x 127.7 x 74 mm
SB3A-XX*	Standard 3" Box w/Cell Divider & Drain Hole		

\* To order, replace XX with 144,100,81,64,49,36,25 or 16 for cell dividers.

\*\* ω<sup>1</sup>=0.221b(0.1kg) for cardboard box, 0.371b(0.17kg) for plastic box, 0.841b(0.38kg) for stainless steel box, 0.531b(0.24kg) for aluminum box.

### Freezer Rack Labeling and Identification Tags

Specifically identify your racks using our label cards or metal tags. Plastic label cards are used for upright freezer drawer racks and are placed into the card holders. Brass metal tags with either numbers or letters may be used for upright freezer, chest freezer and liquid nitrogen tank racks. Brass tags are available in several colors: natural, blue, red, yellow or green.

### Label Cards for Drawer Racks

Pack of 50

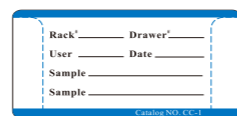

Part Number	Description	Dimension
DL-P	Plastic Cards	2 11/16 x 1 3/8 inch 68 x 35 mm

(Continued on next page)

## Cryo-Canes, Dewar Flasks, Identification Tags

### Metal Tags for Freezer Racks



Part Number	Description
Brass Tags	TAG-N* TAG-L*
Coloured Aluminum Tags	TAG-N-X*** TAG-L-X****

\* Specify number(s) required on each TAG when ordering.

\*\* Specify letter(s) required on each TAG when ordering.

\*\*\* Specify number(s) required on each TAG and desired color X: B-blue, R-red, Y-yellow or G-green when ordering.

\*\*\*\* Specify letter(s) required on each TAG and desired color X: B-blue, R-red, Y-yellow or G-green when ordering.

### Aluminum Cryo-Canes

Aluminum cryo-canes are available in two styles, with and without vial platforms. Each cryo-cane holds either five 1.0, 1.2, 1.5, 1.8, 2.0ml cryogenic vials (with vial platform) or 1.0, 1.2, 1.5, 1.8, 2.0, 5.0ml cryogenic vials (no vial platform).



Part Number	Description	Dimension Wt x Wt x H	Package
LFC-6T	Cryo-canes w/o platform	289 x 12.8 x 8.4 mm	Pk of 12
LFC-5L	Cryo-canes with platform	289 x 12.8 x 8.4 mm	Pk of 12
PC-511	Clear Plastic Sleeve	276 x 16 x 0.5 mm	100 pcs / case

### Metal Tags for Aluminum Cryo-Canes

Metal tags for aluminum cryo-canes are sold in packs of 12 come in 5 different colors. Tags are clipped onto the ends of the cryo-canes to allow easy identification of samples.

Part Number	Color	Package	Appearance
PC-501	Red	Pk of 12	
PC-502	Yellow		
PC-503	Blue		
PC-504	Green		
PC-505	White		

### Stainless Steel Dewar Flasks

Store and transport low-temperature liquid gases or high temperature liquids. Dewars are available in two sizes 1000ml or 500ml and come complete with vented stainless steel lids. Model SDF-1000 comes with removable stainless steel handle.

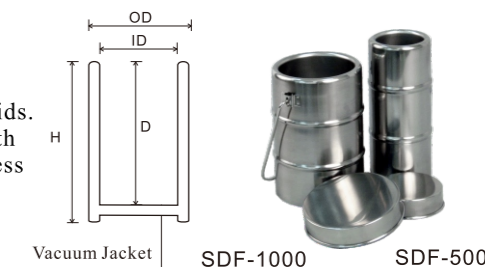

Item	Capacity	OD	ID	H	D
SDF-500	500 ml	86 mm 3.4 inch	65 mm 2.56 inch	203 mm 7.99 inch	182 mm 7.17 inch
SDF-1000	1000 ml	122 mm 4.8 inch	100 mm 3.93 inch	177 mm 6.97 inch	157 mm 6.18 inch

# Security Lock Devices for Chest Freezer & Liquid Nitrogen Tank Racks

Security lock devices for chest freezer and liquid nitrogen tank racks are made of high quality stainless steel and secured with a lock included with each system. Select your lock device by identifying your specific chest freezer or liquid nitrogen tank rack and then the security lock device for your particular freezer rack.

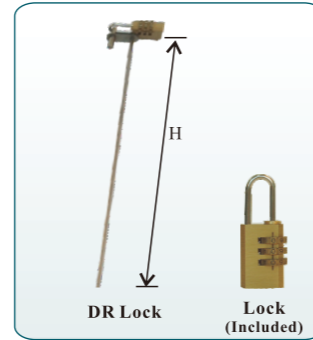

Lock Device	Lock Dimension	Applicable to Rack	Rack Height
	H		
DR-06	6 <sup>5</sup> / <sub>16</sub> inch 160 mm	CF-3-2 CFA-3-2 MCF-3-2	6 <sup>5</sup> / <sub>8</sub> inch 168 mm
DR-06S	6 <sup>5</sup> / <sub>16</sub> inch 160 mm	CFM-305	6 <sup>3</sup> / <sub>4</sub> inch 171 mm
		CFM-315	6 <sup>1</sup> / <sub>16</sub> inch 176 mm
DR-09	8 <sup>1</sup> / <sub>16</sub> inch 220 mm	CF-4-2 CFA-4-2 MCF-4-2	8 <sup>1</sup> / <sub>16</sub> inch 224 mm
DR-09S	8 <sup>1</sup> / <sub>16</sub> inch 220 mm	CFM-405	9 inch 228 mm
		CFM-415	9 <sup>1</sup> / <sub>4</sub> inch 235 mm
DR-11	10 <sup>1</sup> / <sub>16</sub> inch 275 mm	CF-5-2 CFA-5-2 MCF-5-2	11 inch 280 mm
DR-11S	10 <sup>1</sup> / <sub>16</sub> inch 275 mm	CFM-505	11 <sup>1</sup> / <sub>4</sub> inch 285 mm
		CFM-515	11 <sup>1</sup> / <sub>16</sub> inch 293 mm
DR-12	12 <sup>3</sup> / <sub>8</sub> inch 320 mm	CF-6-2 CFA-6-2 MCF-6-2	13 <sup>3</sup> / <sub>4</sub> inch 336 mm
		CF-4-3 CFA-4-3 MCF-4-3	12 <sup>1</sup> / <sub>16</sub> inch 323 mm
DR-12S	12 <sup>3</sup> / <sub>8</sub> inch 320 mm	CFM-605	13 <sup>3</sup> / <sub>16</sub> inch 341 mm
		CFM-615	13 <sup>3</sup> / <sub>8</sub> inch 352 mm
		CF-7-2 CFA-7-2 MCF-7-2	15 <sup>1</sup> / <sub>16</sub> inch 392 mm
DR-15	15 <sup>3</sup> / <sub>8</sub> inch 390 mm	CF-5-3 CFA-5-3 MCF-5-3	15 <sup>3</sup> / <sub>8</sub> inch 404 mm
		CFDP-9	16 <sup>7</sup> / <sub>16</sub> inch 417 mm
		CFMP-5	16 <sup>7</sup> / <sub>16</sub> inch 421 mm
DR-15S	15 <sup>3</sup> / <sub>8</sub> inch 390 mm	CFM-705	15 <sup>5</sup> / <sub>16</sub> inch 398 mm
		CFM-715	16 <sup>1</sup> / <sub>8</sub> inch 410 mm
		CF-8-2 CFA-8-2 MCF-8-2	17 <sup>3</sup> / <sub>8</sub> inch 447 mm
DR-17	17 <sup>1</sup> / <sub>2</sub> inch 445 mm	CF-6-3 CFA-6-3 MCF-6-3	19 <sup>1</sup> / <sub>8</sub> inch 485 mm
		MCF-6-3	19 <sup>1</sup> / <sub>8</sub> inch 485 mm
		CFHT-8	18 <sup>7</sup> / <sub>16</sub> inch 469 mm
		CFTB-8	17 <sup>1</sup> / <sub>16</sub> inch 449 mm
		CFDP-10	18 <sup>1</sup> / <sub>4</sub> inch 463 mm
DR-17S	17 <sup>1</sup> / <sub>2</sub> inch 445 mm	CFM-805	17 <sup>1</sup> / <sub>16</sub> inch 455 mm
		CFM-815	18 <sup>7</sup> / <sub>16</sub> inch 469 mm
		CF-9-2 CFA-9-2	19 <sup>1</sup> / <sub>16</sub> inch 503 mm
DR-19	19 <sup>1</sup> / <sub>2</sub> inch 496 mm	MCF-9-2 MCF-9-2-S MCFA-9-2	19 <sup>1</sup> / <sub>16</sub> inch 503 mm
		CFHT-9	20 <sup>3</sup> / <sub>4</sub> inch 527 mm
		CFLB-4	20 <sup>1</sup> / <sub>16</sub> inch 510 mm
		CFTB-9	19 <sup>1</sup> / <sub>16</sub> inch 506 mm
		CFDP-11	20 <sup>1</sup> / <sub>16</sub> inch 509 mm
		CFMP-6	19 <sup>3</sup> / <sub>8</sub> inch 505 mm
DR-19S	19 <sup>1</sup> / <sub>2</sub> inch 496 mm	CFM-905	20 <sup>3</sup> / <sub>16</sub> inch 512 mm
		CFM-915	20 <sup>3</sup> / <sub>4</sub> inch 527 mm

- \*Protect your samples from unauthorized access using these security lock devices.
- \*No tools are required for installing lock devices.
- \*Locking devices are made of durable stainless steel.

(Continued on next page)

# Security Lock Devices for Chest Freezer & Liquid Nitrogen Tank Racks

Lock device	Lock Dimension	Applicable to Rack	Rack Height
	H		
DR-22	21 <sup>1</sup> / <sub>16</sub> inch 550 mm	CF-10-2 CF-10-2-S CFA-10-2	22 inch 559 mm
		MCF-10-2 MCF-10-2-S MCFA-10-2	22 inch 559 mm
		CF-7-3 CF-7-3-S CFA-7-3	22 <sup>1</sup> / <sub>4</sub> inch 565 mm
		MCF-7-3 MCFA-7-3	22 <sup>1</sup> / <sub>4</sub> inch 565 mm
		CFHT-10	23 <sup>3</sup> / <sub>16</sub> inch 586 mm
		CFTB-10	22 <sup>3</sup> / <sub>8</sub> inch 562 mm
		CFDP-12	21 <sup>7</sup> / <sub>8</sub> inch 556 mm
		CFMP-7	23 <sup>3</sup> / <sub>16</sub> inch 589 mm
DR-22S	21 <sup>1</sup> / <sub>16</sub> inch 550 mm	CFM-1005	22 <sup>3</sup> / <sub>8</sub> inch 569 mm
		CFM-1015	23 <sup>3</sup> / <sub>16</sub> inch 586 mm
DR-23	23 <sup>3</sup> / <sub>8</sub> inch 595 mm	CF-11-2 CF-11-2-S CFA-11-2	24 <sup>3</sup> / <sub>16</sub> inch 615 mm
		MCF-11-2 MCF-11-2-S MCFA-11-2	24 <sup>3</sup> / <sub>16</sub> inch 615 mm
		CFTB-11	24 <sup>3</sup> / <sub>16</sub> inch 618 mm
		CFDP-13	23 <sup>1</sup> / <sub>16</sub> inch 602 mm
		CFLB-5	25 <sup>1</sup> / <sub>16</sub> inch 637 mm
DR-23S	23 <sup>3</sup> / <sub>8</sub> inch 595 mm	CFM-1105	24 <sup>3</sup> / <sub>8</sub> inch 625 mm
DR-25	25 <sup>1</sup> / <sub>8</sub> inch 638 mm	CF-8-3 CF-8-3-S CFA-8-3	25 <sup>1</sup> / <sub>16</sub> inch 646 mm
		MCF-8-3 MCFA-8-3	25 <sup>1</sup> / <sub>16</sub> inch 646 mm
		CFHT-11	25 <sup>3</sup> / <sub>8</sub> inch 644 mm
		CFDP-14	25 <sup>1</sup> / <sub>2</sub> inch 648 mm
DR-25S	25 <sup>1</sup> / <sub>8</sub> inch 638 mm	CFMP-8	26 <sup>1</sup> / <sub>2</sub> inch 673 mm
		CFM-1115	25 <sup>3</sup> / <sub>8</sub> inch 644 mm
DR-26	26 inch 660 mm	CF-12-2 CF-12-2-S CFA-12-2	26 <sup>3</sup> / <sub>8</sub> inch 670 mm
		MCF-12-2 MCF-12-2-S MCFA-12-2	26 <sup>3</sup> / <sub>8</sub> inch 670 mm
		CFTB-12	26 <sup>3</sup> / <sub>16</sub> inch 674mm
DR-26S	26 inch 660 mm	CFM-1205	26 <sup>3</sup> / <sub>8</sub> inch 682 mm
DR-27	27 <sup>1</sup> / <sub>16</sub> inch 690 mm	CF-13-2 CF-13-2-S CFA-13-2	28 <sup>3</sup> / <sub>16</sub> inch 726 mm
		MCF-13-2 MCF-13-2-S MCFA-13-2	28 <sup>3</sup> / <sub>16</sub> inch 726 mm
		CF-9-3 CF-9-3-S CFA-9-3	28 <sup>3</sup> / <sub>16</sub> inch 726 mm
		MCF-9-3 MCFA-9-3	28 <sup>3</sup> / <sub>16</sub> inch 726 mm
		CFHT-12	27 <sup>1</sup> / <sub>16</sub> inch 703 mm
		CFDP-15	27 <sup>3</sup> / <sub>16</sub> inch 694 mm
		DR-27S	27 <sup>1</sup> / <sub>16</sub> inch 690 mm
DR-29	28 <sup>3</sup> / <sub>8</sub> inch 726 mm	CFHT-13	29 <sup>1</sup> / <sub>16</sub> inch 761 mm
		CFLB-6	30 <sup>1</sup> / <sub>16</sub> inch 764 mm
		CFDP-16	29 <sup>3</sup> / <sub>16</sub> inch 741 mm
		CFMP-9	29 <sup>1</sup> / <sub>16</sub> inch 757 mm
		CFTB-13	28 <sup>3</sup> / <sub>4</sub> inch 730 mm
DR-29S	28 <sup>3</sup> / <sub>8</sub> inch 726 mm	CFM-1305	29 <sup>3</sup> / <sub>8</sub> inch 739 mm
		CFM-1315	29 <sup>3</sup> / <sub>16</sub> inch 761 mm
DR-31	31 inch 776 mm	CF-14-2 CF-14-2-S CFA-14-2	30 <sup>1</sup> / <sub>16</sub> inch 782 mm
		MCF-14-2 MCF-14-2-S MCFA-14-2	30 <sup>1</sup> / <sub>16</sub> inch 782 mm
		CF-10-3 CF-10-3-S CAF-10-3	31 <sup>3</sup> / <sub>4</sub> inch 807 mm
		MCF-10-3 MCFA-10-3	31 <sup>3</sup> / <sub>4</sub> inch 807 mm
DR-32	32 <sup>1</sup> / <sub>16</sub> inch 820 mm	CF-15-2 CF-15-2-S CFA-15-2	33 inch 838 mm
		MCF-15-2 MCF-15-2-S MCFA-15-2	33 inch 838 mm

- \*Protect your samples from unauthorized access using these security lock devices.
- \*No tools are required for installing lock devices.
- \*Locking devices are made of durable stainless steel.

(Continued on next page)

# Security Lock Devices for Upright Freezer Racks

Security lock devices for upright freezer racks are made of high quality stainless steel and secured with a lock included with each system. Select your lock device by identifying your specific upright freezer rack and then the security lock device for your particular freezer rack.

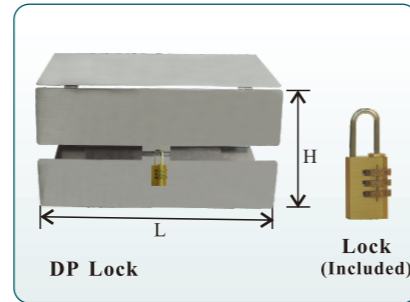

Lock Device	Lock Dimension		Applicable to Rack	Rack Height
	L	H		
DP-0507	4 <sup>1</sup> / <sub>4</sub> inch 120 mm	6 <sup>3</sup> / <sub>8</sub> -7 <sup>1</sup> / <sub>8</sub> inch 171-181 mm	UFM-1305	6 <sup>5</sup> / <sub>8</sub> inch 169 mm
DP-0509	4 <sup>3</sup> / <sub>4</sub> inch 120 mm	8 <sup>7</sup> / <sub>8</sub> -9 <sup>5</sup> / <sub>16</sub> inch 226-236 mm	UFM-1405	8 <sup>13</sup> / <sub>16</sub> inch 224 mm
DP-0511	4 <sup>3</sup> / <sub>4</sub> inch 120 mm	11 <sup>1</sup> / <sub>8</sub> -11 <sup>1</sup> / <sub>2</sub> inch 282-292 mm	UFM-1505	11 inch 280 mm
DP-0607	5 <sup>1</sup> / <sub>2</sub> inch 140 mm	7 - 7 <sup>7</sup> / <sub>16</sub> inch 178-188 mm	UFM-1315	6 <sup>15</sup> / <sub>16</sub> inch 176 mm
DP-0609	5 <sup>1</sup> / <sub>2</sub> inch 140 mm	9 <sup>9</sup> / <sub>16</sub> -9 <sup>3</sup> / <sub>4</sub> inch 237-247 mm	UFM-1415	9 <sup>1</sup> / <sub>4</sub> inch 235 mm
DP-0612	5 <sup>1</sup> / <sub>2</sub> inch 140 mm	11 <sup>3</sup> / <sub>8</sub> -12 inch 295-305 mm	UFM-1515	11 <sup>9</sup> / <sub>16</sub> inch 293 mm
DP-1107	10 <sup>7</sup> / <sub>16</sub> inch 259 mm	6 <sup>11</sup> / <sub>16</sub> -7 <sup>1</sup> / <sub>8</sub> inch 171-181 mm	UFM-2305	6 <sup>5</sup> / <sub>8</sub> inch 169 mm
DP-1109	10 <sup>7</sup> / <sub>16</sub> inch 259 mm	8 <sup>7</sup> / <sub>8</sub> -9 <sup>5</sup> / <sub>16</sub> inch 226-236 mm	UFM-2405	8 <sup>13</sup> / <sub>16</sub> inch 224 mm
DP-1111	10 <sup>7</sup> / <sub>16</sub> inch 259 mm	11 <sup>1</sup> / <sub>8</sub> -11 <sup>1</sup> / <sub>2</sub> inch 282-292 mm	UFM-2505	11 inch 280 mm
DP-1210	11 <sup>7</sup> / <sub>16</sub> inch 290 mm	9 <sup>15</sup> / <sub>16</sub> -10 <sup>3</sup> / <sub>8</sub> inch 253-263 mm	UFLB-22	10 <sup>9</sup> / <sub>16</sub> inch 259 mm
DP-1307	11 <sup>3</sup> / <sub>4</sub> inch 298 mm	7 - 7 <sup>7</sup> / <sub>16</sub> inch 178-188 mm	UFHT-23	6 <sup>15</sup> / <sub>16</sub> inch 176 mm
			UFM-2315	6 <sup>15</sup> / <sub>16</sub> inch 176 mm
DP-1309	11 <sup>3</sup> / <sub>4</sub> inch 298 mm	9 <sup>9</sup> / <sub>16</sub> -9 <sup>3</sup> / <sub>4</sub> inch 237-247 mm	UFHT-24	9 <sup>1</sup> / <sub>4</sub> inch 235 mm
			UFM-2415	9 <sup>1</sup> / <sub>4</sub> inch 235 mm
DP-1312	11 <sup>3</sup> / <sub>4</sub> inch 298 mm	11 <sup>5</sup> / <sub>8</sub> -12 inch 295-305 mm	UFHT-25	11 <sup>9</sup> / <sub>16</sub> inch 293 mm
			UFM-2515	11 <sup>9</sup> / <sub>16</sub> inch 293 mm
DP-1607	15 <sup>9</sup> / <sub>16</sub> inch 395 mm	6 <sup>11</sup> / <sub>16</sub> -7 <sup>1</sup> / <sub>8</sub> inch 170-180 mm	UF-332	6 <sup>5</sup> / <sub>8</sub> inch 168 mm
			UF-323	6 <sup>5</sup> / <sub>8</sub> inch 168 mm
DP-1609	15 <sup>9</sup> / <sub>16</sub> inch 395 mm	8 <sup>15</sup> / <sub>16</sub> -9 <sup>5</sup> / <sub>16</sub> inch 227-237 mm	UF-342	8 <sup>7</sup> / <sub>8</sub> inch 225 mm
DP-1610	15 <sup>9</sup> / <sub>16</sub> inch 395 mm	9 <sup>7</sup> / <sub>16</sub> -9 <sup>13</sup> / <sub>16</sub> inch 239-249 mm	UF-333	9 <sup>3</sup> / <sub>8</sub> inch 238 mm
DP-1611	15 <sup>9</sup> / <sub>16</sub> inch 395 mm	11 <sup>1</sup> / <sub>8</sub> -11 <sup>1</sup> / <sub>2</sub> inch 282-292 mm	UF-352	11 inch 280 mm
DP-1613	15 <sup>9</sup> / <sub>16</sub> inch 395 mm	12 <sup>3</sup> / <sub>4</sub> -13 <sup>1</sup> / <sub>8</sub> inch 323-333 mm	UF-362	12 <sup>3</sup> / <sub>8</sub> inch 321 mm
DP-1707	15 <sup>11</sup> / <sub>16</sub> inch 398 mm	6 <sup>3</sup> / <sub>4</sub> -7 <sup>1</sup> / <sub>8</sub> inch 171-181 mm	UFM-3305	6 <sup>5</sup> / <sub>8</sub> inch 169 mm
DP-1709	15 <sup>11</sup> / <sub>16</sub> inch 398 mm	8 <sup>7</sup> / <sub>8</sub> -9 <sup>5</sup> / <sub>16</sub> inch 226-236 mm	UFM-3405	8 <sup>13</sup> / <sub>16</sub> inch 224 mm
DP-1711	15 <sup>11</sup> / <sub>16</sub> inch 398 mm	11 <sup>1</sup> / <sub>8</sub> -11 <sup>1</sup> / <sub>2</sub> inch 282-292 mm	UFM-3505	11 inch 280 mm

\*Protect your samples from unauthorized access using these security lock devices.

\*No tools are required for installing lock devices.

\*Locking devices are made of durable stainless steel.

(Continued on next page)

# Security Lock Devices for Upright Freezer Racks

Lock Device	Lock Dimension		Applicable to Rack	Rack Height
	L	H		
DP-1809	17 <sup>7</sup> / <sub>16</sub> inch 446 mm	8 <sup>7</sup> / <sub>8</sub> -9 <sup>5</sup> / <sub>16</sub> inch 226-236 mm	UFTB-54	8 <sup>13</sup> / <sub>16</sub> inch 224 mm
		9 <sup>1</sup> / <sub>4</sub> -10 <sup>1</sup> / <sub>16</sub> inch 235-255 mm	UFDP-55	9 <sup>3</sup> / <sub>16</sub> inch 233 mm
			UFMP-509	9 <sup>9</sup> / <sub>16</sub> inch 233 mm
DP-1810	17 <sup>7</sup> / <sub>16</sub> inch 443 mm	9 <sup>15</sup> / <sub>16</sub> -10 <sup>9</sup> / <sub>16</sub> inch 252-262 mm	UFLB-32	10 <sup>9</sup> / <sub>16</sub> inch 259 mm
DP-1907	17 <sup>15</sup> / <sub>16</sub> inch 456 mm	7 - 7 <sup>7</sup> / <sub>16</sub> inch 178-188 mm	UFHT-33	6 <sup>15</sup> / <sub>16</sub> inch 176 mm
			UFM-3315	6 <sup>15</sup> / <sub>16</sub> inch 176 mm
DP-1909	17 <sup>15</sup> / <sub>16</sub> inch 456 mm	9 <sup>9</sup> / <sub>16</sub> -9 <sup>3</sup> / <sub>4</sub> inch 237-247 mm	UFHT-34	9 <sup>1</sup> / <sub>4</sub> inch 235 mm
			UFM-3415	9 <sup>1</sup> / <sub>4</sub> inch 235 mm
DP-1911	17 <sup>7</sup> / <sub>16</sub> inch 446 mm	11 <sup>1</sup> / <sub>8</sub> -11 <sup>1</sup> / <sub>2</sub> inch 282-292 mm	UFDP-56	11 inch 280 mm
			UFTB-55	11 inch 280 mm
			UFMP-511	11 inch 280 mm
DP-1912	17 <sup>15</sup> / <sub>16</sub> inch 456 mm	11 <sup>5</sup> / <sub>8</sub> -12 inch 295-305 mm	UFHT-35	11 <sup>9</sup> / <sub>16</sub> inch 293 mm
			UFM-3515	11 <sup>9</sup> / <sub>16</sub> inch 293 mm
DP-2107	20 <sup>7</sup> / <sub>8</sub> inch 530 mm	6 <sup>11</sup> / <sub>16</sub> -7 <sup>1</sup> / <sub>8</sub> inch 170-180 mm	UF-432	6 <sup>5</sup> / <sub>8</sub> inch 168 mm
			UF-423	6 <sup>5</sup> / <sub>8</sub> inch 168 mm
DP-2109	20 <sup>7</sup> / <sub>8</sub> inch 530 mm	8 <sup>15</sup> / <sub>16</sub> -9 <sup>5</sup> / <sub>16</sub> inch 227-237 mm	UF-442	8 <sup>7</sup> / <sub>8</sub> inch 225 mm
DP-2110	20 <sup>7</sup> / <sub>8</sub> inch 530 mm	9 <sup>7</sup> / <sub>16</sub> -9 <sup>13</sup> / <sub>16</sub> inch 239-249 mm	UF-433	9 <sup>3</sup> / <sub>8</sub> inch 238 mm
DP-2111	20 <sup>7</sup> / <sub>8</sub> inch 530 mm	11 <sup>1</sup> / <sub>8</sub> -11 <sup>1</sup> / <sub>2</sub> inch 282-292 mm	UF-452	11 inch 280 mm
DP-2112	21 <sup>1</sup> / <sub>8</sub> inch 542 mm	12 <sup>3</sup> / <sub>4</sub> -13 <sup>1</sup> / <sub>8</sub> inch 323-333 mm	UF-443	12 <sup>3</sup> / <sub>8</sub> inch 321 mm
DP-2113	20 <sup>7</sup> / <sub>8</sub> inch 530 mm	12 <sup>3</sup> / <sub>4</sub> -13 <sup>1</sup> / <sub>8</sub> inch 323-333 mm	UF-462	12 <sup>3</sup> / <sub>8</sub> inch 321 mm
DP-2207	21 <sup>1</sup> / <sub>8</sub> inch 536 mm	6 <sup>3</sup> / <sub>4</sub> -7 <sup>1</sup> / <sub>8</sub> inch 171-181 mm	UFM-4305	6 <sup>5</sup> / <sub>8</sub> inch 169 mm
DP-2209	21 <sup>3</sup> / <sub>16</sub> inch 538 mm	9 <sup>1</sup> / <sub>4</sub> -10 <sup>1</sup> / <sub>16</sub> inch 235-255 mm	UFDP-65	9 <sup>3</sup> / <sub>16</sub> inch 233 mm
			UFMP-609	9 <sup>3</sup> / <sub>16</sub> inch 233 mm
			UFTB-64	8 <sup>13</sup> / <sub>16</sub> inch 224 mm
DP-2211	21 <sup>3</sup> / <sub>16</sub> inch 538 mm	8 <sup>7</sup> / <sub>8</sub> -9 <sup>5</sup> / <sub>16</sub> inch 226-236 mm	UFM-4405	8 <sup>13</sup> / <sub>16</sub> inch 224 mm
			UFDP-66	11 inch 280 mm
DP-2211	21 <sup>3</sup> / <sub>16</sub> inch 538 mm	11 <sup>1</sup> / <sub>8</sub> -11 <sup>1</sup> / <sub>2</sub> inch 282-292 mm	UFTB-65	11 inch 280 mm
			UFMP-611	11 inch 280 mm
			UFM-4505	11 inch 280 mm
DP-2410	23 <sup>3</sup> / <sub>8</sub> inch 600 mm	9 <sup>15</sup> / <sub>16</sub> -10 <sup>3</sup> / <sub>8</sub> inch 253-263 mm	UFLB-42	10 <sup>9</sup> / <sub>16</sub> inch 259 mm
DP-2609	24 <sup>13</sup> / <sub>16</sub> inch 631 mm	9 <sup>1</sup> / <sub>4</sub> -9 <sup>3</sup> / <sub>4</sub> inch 235-245 mm	UFMP-709	9 <sup>9</sup> / <sub>16</sub> inch 233 mm
DP-2611	24 <sup>13</sup> / <sub>16</sub> inch 631 mm	11 <sup>1</sup> / <sub>8</sub> -11 <sup>1</sup> / <sub>2</sub> inch 282-292 mm	UFMP-711	11 inch 280 mm
DP-2707	25 <sup>13</sup> / <sub>16</sub> inch 659 mm	6 <sup>11</sup> / <sub>16</sub> -7 <sup>1</sup> / <sub>8</sub> inch 170-180 mm	UF-532	6 <sup>5</sup> / <sub>8</sub> inch 168 mm
DP-2709	25 <sup>13</sup> / <sub>16</sub> inch 659 mm	8 <sup>15</sup> / <sub>16</sub> -9 <sup>5</sup> / <sub>16</sub> inch 227-237 mm	UF-542	8 <sup>7</sup> / <sub>8</sub> inch 225 mm
DP-2710	25 <sup>13</sup> / <sub>16</sub> inch 659 mm	9 <sup>9</sup> / <sub>16</sub> -9 <sup>15</sup> / <sub>16</sub> inch 243-253 mm	UF-533	9 <sup>1</sup> / <sub>2</sub> inch 241 mm
DP-2711	25 <sup>13</sup> / <sub>16</sub> inch 659 mm	11 <sup>1</sup> / <sub>8</sub> -11 <sup>1</sup> / <sub>2</sub> inch 282-292 mm	UF-552	11 inch 280 mm
DP-2713	25 <sup>13</sup> / <sub>16</sub> inch 659 mm	12 <sup>3</sup> / <sub>4</sub> -13 <sup>1</sup> / <sub>8</sub> inch 323-333 mm	UF-543	12 <sup>3</sup> / <sub>8</sub> inch 321 mm

\*Protect your samples from unauthorized access using these security lock devices.

\*No tools are required for installing lock devices.

\*Locking devices are made of durable stainless steel.

(Continued on next page)

# Security Lock Devices for Upright Freezer Drawer Racks

Security lock devices for upright freezer drawer racks are made of high quality stainless steel and secured with a lock included with each system. Select your lock device by identifying your specific upright freezer drawer rack and then the security lock device for your particular freezer rack.

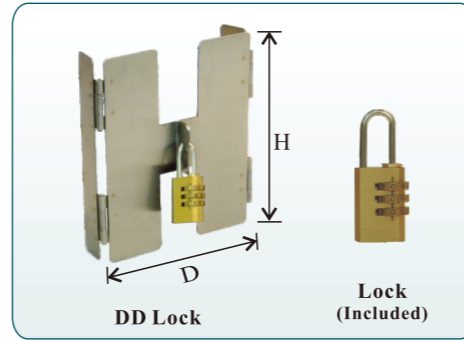

Lock Device	Lock Dimension		Applicable to Rack	Rack Height
	D	H		
DD-03	5 <sup>11</sup> / <sub>16</sub> inch 144 mm	3 <sup>11</sup> / <sub>16</sub> inch 94 mm	UFD-B03-2	6 <sup>1</sup> / <sub>16</sub> inch 154 mm
			UFD-T03-2	6 <sup>1</sup> / <sub>16</sub> inch 154 mm
			UFD-LB03-2	6 <sup>1</sup> / <sub>16</sub> inch 154 mm
			UFD-LT03-2	6 <sup>1</sup> / <sub>16</sub> inch 154 mm
			UFD-T01-2	6 <sup>1</sup> / <sub>16</sub> inch 154 mm
			UFD-LT01-2	6 <sup>1</sup> / <sub>16</sub> inch 154 mm
DD-04	5 <sup>11</sup> / <sub>16</sub> inch 144 mm	4 <sup>3</sup> / <sub>16</sub> inch 106 mm	UFD-B10-1	4 <sup>1</sup> / <sub>2</sub> inch 114 mm
			UFD-T10-1	4 <sup>1</sup> / <sub>2</sub> inch 114 mm
			UFD-LB10-1	4 <sup>1</sup> / <sub>2</sub> inch 114 mm
			UFD-LT10-1	4 <sup>1</sup> / <sub>2</sub> inch 114 mm
			UFD-T06-1	4 <sup>1</sup> / <sub>2</sub> inch 114 mm
			UFD-LT06-1	4 <sup>1</sup> / <sub>2</sub> inch 114 mm
			UFD-B-1	4 <sup>15</sup> / <sub>16</sub> inch 126 mm
			UFD-T15-1	4 <sup>15</sup> / <sub>16</sub> inch 126 mm
			UFD-T50-1	4 <sup>15</sup> / <sub>16</sub> inch 126 mm
			UFD-LB-1	4 <sup>15</sup> / <sub>16</sub> inch 126 mm
			UFD-LT15-1	4 <sup>15</sup> / <sub>16</sub> inch 126 mm
			UFD-LT50-1	4 <sup>15</sup> / <sub>16</sub> inch 126 mm
			UFD-XLB-1	4 <sup>15</sup> / <sub>16</sub> inch 126 mm
			UFD-XLT15-1	4 <sup>15</sup> / <sub>16</sub> inch 126 mm
			UFD-XLT50-1	4 <sup>15</sup> / <sub>16</sub> inch 126 mm
			DD-05	5 <sup>11</sup> / <sub>16</sub> inch 144 mm
UFDDP-43	6 <sup>1</sup> / <sub>8</sub> inch 154 mm			
UFDDP-53	6 <sup>1</sup> / <sub>8</sub> inch 154 mm			
UFDDP-63	6 <sup>1</sup> / <sub>8</sub> inch 154 mm			
UFDDP-73	6 <sup>1</sup> / <sub>8</sub> inch 154 mm			
DD-06	5 <sup>11</sup> / <sub>16</sub> inch 144 mm	6 <sup>3</sup> / <sub>8</sub> inch 161 mm	UFD-332	7 <sup>1</sup> / <sub>8</sub> inch 181 mm
			UFD-432	7 <sup>1</sup> / <sub>8</sub> inch 181 mm
			UFD-532	7 <sup>1</sup> / <sub>8</sub> inch 181 mm
			UFD-323	6 <sup>7</sup> / <sub>16</sub> inch 164 mm
			UFD-423	6 <sup>7</sup> / <sub>16</sub> inch 164 mm
			UFD-B10-2	9 inch 228 mm
			UFD-T10-2	9 inch 228 mm
			UFD-LB10-2	9 inch 228 mm
			UFD-LT10-2	9 inch 228 mm
			UFD-T06-2	9 inch 228 mm
			UFD-LT06-2	9 inch 228 mm
			UFD-B03-3	9 <sup>1</sup> / <sub>8</sub> inch 231 mm
			UFD-T03-3	9 <sup>1</sup> / <sub>8</sub> inch 231 mm
			UFD-LB03-3	9 <sup>1</sup> / <sub>8</sub> inch 231 mm
			UFD-LT03-3	9 <sup>1</sup> / <sub>8</sub> inch 231 mm
			UFD-T01-3	9 <sup>1</sup> / <sub>8</sub> inch 231 mm
			UFD-LT01-3	9 <sup>1</sup> / <sub>8</sub> inch 231 mm

\*Protect your samples from unauthorized access using these security lock device<sup>ES</sup>.

\*No tools are required for installing lock devices.

\*Locking devices are made of durable stainless steel.

(Continued on next page)

# Security Lock Devices for Upright Freezer Drawer Racks

Lock Device	Lock Dimension		Applicable to Rack	Rack Height
	D	H		
DD-06	5 <sup>11</sup> / <sub>16</sub> inch 144 mm	6 <sup>3</sup> / <sub>8</sub> inch 161 mm	UFDMP-33	7 <sup>1</sup> / <sub>16</sub> inch 186 mm
			UFDMP-43	7 <sup>1</sup> / <sub>16</sub> inch 186 mm
			UFDMP-53	7 <sup>1</sup> / <sub>16</sub> inch 186 mm
			UFDMP-63	7 <sup>1</sup> / <sub>16</sub> inch 186 mm
			UFDMP-73	7 <sup>1</sup> / <sub>16</sub> inch 186 mm
DD-07	5 <sup>11</sup> / <sub>16</sub> inch 144 mm	7 <sup>7</sup> / <sub>16</sub> inch 186 mm	UFDDP-34	8 <sup>1</sup> / <sub>16</sub> inch 205 mm
			UFDDP-44	8 <sup>1</sup> / <sub>16</sub> inch 205 mm
			UFDDP-54	8 <sup>1</sup> / <sub>16</sub> inch 205 mm
			UFDDP-64	8 <sup>1</sup> / <sub>16</sub> inch 205 mm
			UFDDP-74	8 <sup>1</sup> / <sub>16</sub> inch 205 mm
DD-09	5 <sup>11</sup> / <sub>16</sub> inch 144 mm	8 <sup>11</sup> / <sub>16</sub> inch 220 mm	UFD-342	9 <sup>7</sup> / <sub>16</sub> inch 240 mm
			UFD-442	9 <sup>7</sup> / <sub>16</sub> inch 240 mm
			UFD-542	9 <sup>7</sup> / <sub>16</sub> inch 240 mm
			UFD-333	10 <sup>1</sup> / <sub>16</sub> inch 256 mm
			UFD-433	10 <sup>1</sup> / <sub>16</sub> inch 256 mm
			UFD-533	10 <sup>1</sup> / <sub>16</sub> inch 256 mm
			UFD-B-2	9 <sup>15</sup> / <sub>16</sub> inch 252 mm
			UFD-T15-2	9 <sup>15</sup> / <sub>16</sub> inch 252 mm
			UFD-T50-2	9 <sup>15</sup> / <sub>16</sub> inch 252 mm
			UFD-LB-2	9 <sup>15</sup> / <sub>16</sub> inch 252 mm
			UFD-LT15-2	9 <sup>15</sup> / <sub>16</sub> inch 252 mm
			UFD-LT50-2	9 <sup>15</sup> / <sub>16</sub> inch 252 mm
			UFD-XLB-2	9 <sup>15</sup> / <sub>16</sub> inch 252 mm
			UFD-XLT15-2	9 <sup>15</sup> / <sub>16</sub> inch 252 mm
			UFD-XLT50-2	9 <sup>15</sup> / <sub>16</sub> inch 246 mm
			UFD-B-222	9 <sup>15</sup> / <sub>16</sub> inch 246 mm
			UFD-B-322	9 <sup>15</sup> / <sub>16</sub> inch 246 mm
			UFD-LB-422	9 <sup>15</sup> / <sub>16</sub> inch 246 mm
			UFD-T15-222	9 <sup>15</sup> / <sub>16</sub> inch 246 mm
			UFD-T15-322	9 <sup>15</sup> / <sub>16</sub> inch 246 mm
			UFD-LT15-422	9 <sup>15</sup> / <sub>16</sub> inch 246 mm
			UFD-T50-222	9 <sup>15</sup> / <sub>16</sub> inch 246 mm
			UFD-T50-322	9 <sup>15</sup> / <sub>16</sub> inch 246 mm
			UFD-LT50-422	9 <sup>15</sup> / <sub>16</sub> inch 246 mm
			UFDMP-34	9 <sup>3</sup> / <sub>4</sub> inch 247 mm
			UFDMP-44	9 <sup>3</sup> / <sub>4</sub> inch 247 mm
			UFDMP-54	9 <sup>3</sup> / <sub>4</sub> inch 247 mm
UFDMP-64	9 <sup>3</sup> / <sub>4</sub> inch 247 mm			
UFDMP-74	9 <sup>3</sup> / <sub>4</sub> inch 247 mm			
DD-10	5 <sup>11</sup> / <sub>16</sub> inch 144 mm	9 <sup>1</sup> / <sub>8</sub> inch 232 mm	UFDDP-35	10 <sup>1</sup> / <sub>16</sub> inch 256 mm
			UFDDP-45	10 <sup>1</sup> / <sub>16</sub> inch 256 mm
			UFDDP-55	10 <sup>1</sup> / <sub>16</sub> inch 256 mm
			UFDDP-65	10 <sup>1</sup> / <sub>16</sub> inch 256 mm
			UFDDP-75	10 <sup>1</sup> / <sub>16</sub> inch 256 mm
DD-11	5 <sup>11</sup> / <sub>16</sub> inch 144 mm	11 inch 279 mm	UFD-352	11 <sup>13</sup> / <sub>16</sub> inch 300mm
			UFD-452	11 <sup>13</sup> / <sub>16</sub> inch 300mm
			UFDMP-35	12 <sup>1</sup> / <sub>8</sub> inch 308mm
			UFDMP-45	12 <sup>1</sup> / <sub>8</sub> inch 308mm
			UFDMP-55	12 <sup>1</sup> / <sub>8</sub> inch 308mm
			UFDMP-65	12 <sup>1</sup> / <sub>8</sub> inch 308mm
			UFDMP-75	12 <sup>1</sup> / <sub>8</sub> inch 308mm
DDHT-06	6 <sup>3</sup> / <sub>8</sub> inch 168 mm	6 <sup>3</sup> / <sub>8</sub> inch 161 mm	UFDHT-23	7 <sup>1</sup> / <sub>16</sub> inch 186 mm
			UFDHT-33	7 <sup>1</sup> / <sub>16</sub> inch 186 mm
			UFDHT-43	7 <sup>1</sup> / <sub>16</sub> inch 186 mm
DDHT-09	6 <sup>3</sup> / <sub>8</sub> inch 168 mm	8 <sup>11</sup> / <sub>16</sub> inch 220 mm	UFDHT-24	9 <sup>3</sup> / <sub>4</sub> inch 247 mm
			UFDHT-34	9 <sup>3</sup> / <sub>4</sub> inch 247 mm
			UFDHT-44	9 <sup>3</sup> / <sub>4</sub> inch 247 mm
DDHT-11	6 <sup>3</sup> / <sub>8</sub> inch 168 mm	11 inch 279 mm	UFDHT-25	12 <sup>1</sup> / <sub>8</sub> inch 308mm
			UFDHT-35	12 <sup>1</sup> / <sub>8</sub> inch 308mm

\*Protect your samples from unauthorized access using these security lock devices.

\*No tools are required for installing lock devices.

\*Locking devices are made of durable stainless steel.

(Continued on next page)

## Aluminum Canisters

For Blood Bags, Bone Marrow, Stem Cell, Cord Blood & Plasma Bags

Canisters constructed of lightweight aluminum are made for most popular brands of bags including Baxter Fenwal, Chartered, Gambro and Stericon. Canisters have locking handle and thumb hole

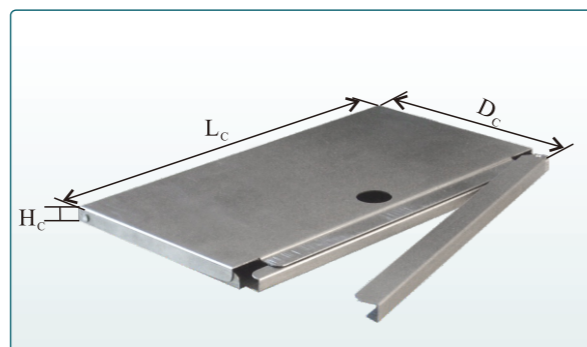

### For BAXTER/FENWAL BAGS

Canister Part Number	Blood Bag Number	Description	Dimension L <sub>c</sub> x D <sub>c</sub> x H <sub>c</sub>	Frames	Platform Dividers
C-4R9951	4R-9951	BAXTER/FENWAL Blood Bag Canister	6 <sup>7</sup> / <sub>16</sub> x 3 <sup>9</sup> / <sub>16</sub> x <sup>7</sup> / <sub>16</sub> inch 163 x 90 x 11 mm	F-C-4R9951-5 F-C-4R9951-7 F-C-4R9951-8	P20-4R9951 P24-4R9951 P31-4R9951 P39-4R9951
C-4R9953	4R-9953 4R-5461	BAXTER/FENWAL Blood Bag Canister	7 <sup>15</sup> / <sub>16</sub> x 5 <sup>1</sup> / <sub>2</sub> x <sup>1</sup> / <sub>2</sub> inch 201 x 140 x 12 mm	F-C-4R9953-3 F-C-4R9953-4 F-C-4R9953-5	P20-4R9953 P24-4R9953 P31-4R9953 P39-4R9953
C-4R9955	4R-9955 4R-5462	BAXTER/FENWAL Blood Bag Canister	9 <sup>7</sup> / <sub>8</sub> x 5 <sup>1</sup> / <sub>2</sub> x <sup>1</sup> / <sub>2</sub> inch 251 x 140 x 12 mm	F-C-4R9955-3 F-C-4R9955-4 F-C-4R9955-5	P20-4R9955 P24-4R9955 P31-4R9955 P39-4R9955
C-4R9957	4R-9957 4R-5463	BAXTER/FENWAL Blood Bag Canister	10 <sup>7</sup> / <sub>8</sub> x 5 <sup>1</sup> / <sub>2</sub> x <sup>1</sup> / <sub>2</sub> inch 277 x 140 x 12 mm	F-C-4R9957-3 F-C-4R9957-4 F-C-4R9957-5	P20-4R9957 P24-4R9957 P31-4R9957 P39-4R9957
C-4R9959	4R-9959 4R-5464	BAXTER/FENWAL Blood Bag Canister	13 <sup>3</sup> / <sub>8</sub> x 5 <sup>1</sup> / <sub>2</sub> x <sup>1</sup> / <sub>2</sub> inch 340 x 140 x 12 mm	F-C-4R9959-3 F-C-4R9959-4 F-C-4R9959-5	P20-4R9959 P24-4R9959 P31-4R9959 P39-4R9959
C-4R2111	4R-2111	BAXTER/FENWAL Blood Bag Canister	8 <sup>1</sup> / <sub>2</sub> x 6 <sup>1</sup> / <sub>4</sub> x <sup>13</sup> / <sub>16</sub> inch 216 x 159 x 20 mm	F-C-4R2111-3 F-C-4R2111-4	P20-4R2111 P24-4R2111 P31-4R2111 P39-4R2111
C-4R2110	4R-2110	BAXTER/FENWAL Blood Bag Canister	10 x 8 <sup>1</sup> / <sub>16</sub> x <sup>13</sup> / <sub>16</sub> inch 254 x 204 x 20 mm	F-C-4R2110-3 F-C-4R2110-4	P20-4R2110 P24-4R2110 P31-4R2110 P39-4R2110

### For STERICON BAGS

Part Number	Blood Bag Number	Description	Dimension L <sub>c</sub> x D <sub>c</sub> x H <sub>c</sub>	Frames	Platform Dividers
C-91D	RCM-91D	STERICON Blood Bag Canister	11 x 5 <sup>1</sup> / <sub>2</sub> x <sup>1</sup> / <sub>2</sub> inch 280 x 140 x 12 mm	F-C-91D-3 F-C-91D-4 F-C-91D-5	P20-91D P24-91D P31-91D P39-91D

## Aluminum Canisters

For Bone Marrow, Stem Cell, Cord Blood & Plasma Bags

### For CHARTERED BAGS

Part Number	Blood Bag Number	Description	Dimension L <sub>c</sub> x D <sub>c</sub> x H <sub>c</sub>	Frames	Platform Dividers
C-7120	7120-2	CHARTERED Blood Bag Canister	5 <sup>1</sup> / <sub>8</sub> x 4 <sup>3</sup> / <sub>16</sub> x <sup>7</sup> / <sub>16</sub> inch 130 x 107 x 11 mm	F-C-7120-4 F-C-7120-5 F-C-7120-6	P20-7120 P24-7120 P31-7120 P39-7120
C-7005	7005-2 7303-2 7039-2	CHARTERED Blood Bag Canister	9 <sup>1</sup> / <sub>8</sub> x 7 <sup>3</sup> / <sub>8</sub> x <sup>7</sup> / <sub>16</sub> inch 232 x 188 x 11 mm	F-C-7005-2 F-C-7005-3	P20-7005 P24-7005 P31-7005 P39-7005
C-7400	7400-2 7403-2 7410-2 7025-2	CHARTERED Blood Bag Canister	9 x 9 x <sup>7</sup> / <sub>16</sub> inch 229 x 229 x 11 mm	F-C-7400-2	P20-7400 P24-7400 P31-7400 P39-7400

### For GAMBRO BAGS

Part Number	Blood Bag Number	Description	Dimension L <sub>c</sub> x D <sub>c</sub> x H <sub>c</sub>	Frames	Platform Dividers
C-DF200	DF-200	GAMBRO Blood Bag Canister	6 <sup>7</sup> / <sub>16</sub> x 4 <sup>3</sup> / <sub>16</sub> x <sup>13</sup> / <sub>16</sub> inch 163 x 106 x 21 mm	F-C-DF200-4 F-C-DF200-6	P20-DF200 P24-DF200 P31-DF200 P39-DF200
C-DF700	DF-700	GAMBRO Blood Bag Canister	12 x 6 <sup>3</sup> / <sub>16</sub> x <sup>13</sup> / <sub>16</sub> inch 304.5 x 157 x 21 mm	F-C-DF700-4 F-C-DF700-6	P20-DF700 P24-DF700 P31-DF700 P39-DF700

### For MEDSEP BAGS

Part Number	Blood Bag Number	Description	Dimension L <sub>c</sub> x D <sub>c</sub> x H <sub>c</sub>	Frames/Rack	Platform Dividers
CBBC-V1	791-05 791-05U	Cord Blood Bag Canister	3 <sup>9</sup> / <sub>16</sub> x 3 <sup>3</sup> / <sub>8</sub> x <sup>7</sup> / <sub>16</sub> inch 99.5 x 92 x 11 mm	F-C-CBBC-V1-6 F-C-CBBC-V1-7 F-C-CBBC-V1-8	P20-CBBC-V1 P24-CBBC-V1 P31-CBBC-V1 P39-CBBC-V1
	8-0346-0		3 <sup>9</sup> / <sub>16</sub> x 3 <sup>3</sup> / <sub>8</sub> x <sup>7</sup> / <sub>16</sub> inch 99.5 x 92 x 11 mm	CF-8-3-TN CF-9-3-TN CF-10-3-TN	

(Continued on next page)

(Continued from last page)

## Stainless Steel Canister Frames

Cannister frames are constructed with corrosion resistant stainless steel and include handles.

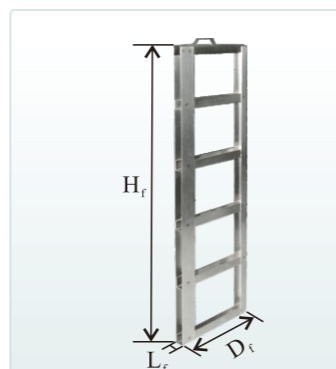

### For BAXTER/FENWAL BAGS

Frame Part Number	Blood Bag Number	Description	Dimensions (D x H x L)	Canister	Platform Dividers
F-C-4R9951-5	4R-9951	Stainless Steel Frame for 5 BAXTER/FENWALC-4R9951 Aluminum Canisters.	5 <sup>11</sup> / <sub>16</sub> x 18 <sup>3</sup> / <sub>4</sub> x <sup>9</sup> / <sub>16</sub> inch 145 x 476 x 15 mm	C-4R9951	P20-4R9951
F-C-4R9951-7		Stainless Steel Frame for 7 BAXTER/FENWALC-4R9951 Aluminum Canisters.	5 <sup>11</sup> / <sub>16</sub> x 26 <sup>1</sup> / <sub>16</sub> x <sup>9</sup> / <sub>16</sub> inch 145 x 662 x 15 mm		P24-4R9951
F-C-4R9951-8		Stainless Steel Frame for 8 BAXTER/FENWALC-4R9951 Aluminum Canisters.	5 <sup>11</sup> / <sub>16</sub> x 29 <sup>3</sup> / <sub>4</sub> x <sup>9</sup> / <sub>16</sub> inch 145 x 755 x 15 mm		P31-4R9951
F-C-4R9953-3	4R-9953 4R-5461	Stainless Steel Frame for 3 BAXTER/FENWALC-4R9953 Aluminum Canisters.	7 <sup>3</sup> / <sub>16</sub> x 17 <sup>3</sup> / <sub>16</sub> x <sup>9</sup> / <sub>16</sub> inch 186 x 440 x 15 mm	C-4R9953	P20-4R9953
F-C-4R9953-4		Stainless Steel Frame for 4 BAXTER/FENWALC-4R9953 Aluminum Canisters.	7 <sup>3</sup> / <sub>16</sub> x 22 <sup>15</sup> / <sub>16</sub> x <sup>9</sup> / <sub>16</sub> inch 186 x 583 x 15 mm		P24-4R9953
F-C-4R9953-5		Stainless Steel Frame for 5 BAXTER/FENWALC-4R9953 Aluminum Canisters.	7 <sup>3</sup> / <sub>16</sub> x 28 <sup>9</sup> / <sub>16</sub> x <sup>9</sup> / <sub>16</sub> inch 186 x 726 x 15 mm		P31-4R9953
F-C-4R9955-3	4R-9955 4R-5462	Stainless Steel Frame for 3 BAXTER/FENWALC-4R9955 Aluminum Canisters.	9 <sup>3</sup> / <sub>16</sub> x 17 <sup>3</sup> / <sub>16</sub> x <sup>9</sup> / <sub>16</sub> inch 234 x 440 x 15 mm	C-4R9955	P20-4R9955
F-C-4R9955-4		Stainless Steel Frame for 4 BAXTER/FENWALC-4R9955 Aluminum Canisters.	9 <sup>3</sup> / <sub>16</sub> x 22 <sup>15</sup> / <sub>16</sub> x <sup>9</sup> / <sub>16</sub> inch 234 x 583 x 15 mm		P24-4R9955
F-C-4R9955-5		Stainless Steel Frame for 5 BAXTER/FENWALC-4R9955 Aluminum Canisters.	9 <sup>3</sup> / <sub>16</sub> x 28 <sup>9</sup> / <sub>16</sub> x <sup>9</sup> / <sub>16</sub> inch 234 x 726 x 15 mm		P31-4R9955
F-C-4R9957-3	4R-9957 4R-5463	Stainless Steel Frame for 3 BAXTER/FENWALC-4R9957 Aluminum Canisters.	10 <sup>5</sup> / <sub>16</sub> x 17 <sup>5</sup> / <sub>16</sub> x <sup>9</sup> / <sub>16</sub> inch 262 x 440 x 15 mm	C-4R9957	P20-4R9957
F-C-4R9957-4		Stainless Steel Frame for 4 BAXTER/FENWALC-4R9957 Aluminum Canisters.	10 <sup>5</sup> / <sub>16</sub> x 22 <sup>15</sup> / <sub>16</sub> x <sup>9</sup> / <sub>16</sub> inch 262 x 583 x 15 mm		P24-4R9957
F-C-4R9957-5		Stainless Steel Frame for 5 BAXTER/FENWALC-4R9957 Aluminum Canisters.	10 <sup>5</sup> / <sub>16</sub> x 28 <sup>9</sup> / <sub>16</sub> x <sup>9</sup> / <sub>16</sub> inch 262 x 726 x 15 mm		P31-4R9957
F-C-4R9959-3	4R-9959 4R-5464	Stainless Steel Frame for 3 BAXTER/FENWALC-4R9959 Aluminum Canisters.	12 <sup>11</sup> / <sub>16</sub> x 17 <sup>3</sup> / <sub>16</sub> x <sup>9</sup> / <sub>16</sub> inch 322 x 440 x 15 mm	C-4R9959	P20-4R9959
F-C-4R9959-4		Stainless Steel Frame for 4 BAXTER/FENWALC-4R9959 Aluminum Canisters.	12 <sup>11</sup> / <sub>16</sub> x 22 <sup>15</sup> / <sub>16</sub> x <sup>9</sup> / <sub>16</sub> inch 322 x 583 x 15 mm		P24-4R9959
F-C-4R9959-5		Stainless Steel Frame for 5 BAXTER/FENWALC-4R9959 Aluminum Canisters.	12 <sup>11</sup> / <sub>16</sub> x 28 <sup>9</sup> / <sub>16</sub> x <sup>9</sup> / <sub>16</sub> inch 322 x 726 x 15 mm		P31-4R9959
F-C-4R2111-3	4R-2111	Stainless Steel Frame for 3 BAXTER/FENWALC-4R2111 Aluminum Canisters.	7 <sup>11</sup> / <sub>16</sub> x 20 x <sup>15</sup> / <sub>16</sub> inch 196 x 508 x 24 mm	C-4R2111	P20-4R2111
F-C-4R2111-4		Stainless Steel Frame for 4 BAXTER/FENWALC-4R2111 Aluminum Canisters.	7 <sup>11</sup> / <sub>16</sub> x 26 <sup>1</sup> / <sub>16</sub> x <sup>15</sup> / <sub>16</sub> inch 196 x 674 x 24 mm		P24-4R2111
F-C-4R2110-3	4R-2110	Stainless Steel Frame for 3 BAXTER/FENWALC-4R2110 Aluminum Canisters.	9 <sup>3</sup> / <sub>16</sub> x 25 <sup>1</sup> / <sub>4</sub> x <sup>15</sup> / <sub>16</sub> inch 234 x 641 x 24 mm	C-4R2110	P20-4R2110
F-C-4R2110-4		Stainless Steel Frame for 4 BAXTER/FENWALC-4R2110 Aluminum Canisters.	9 <sup>3</sup> / <sub>16</sub> x 33 <sup>1</sup> / <sub>2</sub> x <sup>15</sup> / <sub>16</sub> inch 234 x 851 x 24 mm		P24-4R2110

(Continued on next page)

(Continued from last page)

## Stainless Steel Canister Frames

Cannister frames are constructed with corrosion resistant stainless steel and include handles.



### For CHARTERED BAGS

Part Number	Blood Bag Number	Description	Dimensions (D x H x L)	Canister	Platform Dividers
F-C-7120-4	7120-2	Stainless Steel Frame for 4 CHARTERED C-7120 Aluminum Canisters.	4 <sup>5</sup> / <sub>16</sub> x 17 <sup>3</sup> / <sub>4</sub> x <sup>9</sup> / <sub>16</sub> inch 110 x 451 x 15 mm	C-7120	P20-7120
F-C-7120-5		Stainless Steel Frame for 5 CHARTERED C-7120 Aluminum Canisters.	4 <sup>5</sup> / <sub>16</sub> x 22 <sup>1</sup> / <sub>16</sub> x <sup>9</sup> / <sub>16</sub> inch 110 x 561 x 15 mm		P24-7120
F-C-7120-6		Stainless Steel Frame for 6 CHARTERED C-7120 Aluminum Canisters.	4 <sup>5</sup> / <sub>16</sub> x 26 <sup>3</sup> / <sub>16</sub> x <sup>9</sup> / <sub>16</sub> inch 110 x 671 x 15 mm		P31-7120
F-C-7005-2	7005-2 7303-2	Stainless Steel Frame for 2 CHARTERED C-7005 Aluminum Canisters.	8 <sup>5</sup> / <sub>8</sub> x 15 <sup>1</sup> / <sub>2</sub> x <sup>9</sup> / <sub>16</sub> inch 212 x 393 x 15 mm	C-7005	P20-7005
F-C-7005-3		Stainless Steel Frame for 3 CHARTERED C-7005 Aluminum Canisters.	8 <sup>5</sup> / <sub>8</sub> x 22 <sup>15</sup> / <sub>16</sub> x <sup>9</sup> / <sub>16</sub> inch 212 x 582 x 15 mm		P24-7005
F-C-7400-2	7400-2 7403-2 7410-2	Stainless Steel Frame for 2 CHARTERED C-7400 Aluminum Canisters.	8 <sup>1</sup> / <sub>4</sub> x 18 <sup>3</sup> / <sub>16</sub> x <sup>9</sup> / <sub>16</sub> inch 209 x 475 x 15 mm	C-7400	P20-7400
F-C-7400-3			8 <sup>1</sup> / <sub>4</sub> x 27 <sup>1</sup> / <sub>16</sub> x <sup>9</sup> / <sub>16</sub> inch 209 x 707 x 15 mm		P24-7400
			7025-2		

### For GAMBRO BAGS

Part Number	Blood Bag Number	Description	Dimensions (D x H x L)	Canister	Platform Dividers
F-C-DF200-4	DF200	Stainless Steel Frame for 4 GAMBRO C-DF200 Aluminum Canisters.	5 <sup>7</sup> / <sub>8</sub> x 18 x 1 <sup>1</sup> / <sub>8</sub> inch 150 x 457 x 28 mm	C-DF200	P20-DF200
F-C-DF200-6		Stainless Steel Frame for 6 GAMBRO C-DF200 Aluminum Canisters.	5 <sup>7</sup> / <sub>8</sub> x 27 <sup>3</sup> / <sub>16</sub> x 1 <sup>1</sup> / <sub>8</sub> inch 150 x 690 x 28 mm		P24-DF200
F-C-DF700-4	DF700	Stainless Steel Frame for 4 GAMBRO C-DF700 Aluminum Canisters.	11 <sup>3</sup> / <sub>16</sub> x 25 <sup>5</sup> / <sub>8</sub> x <sup>15</sup> / <sub>16</sub> inch 284.5 x 651 x 24 mm	C-DF700	P20-DF700
F-C-DF700-6		Stainless Steel Frame for 6 GAMBRO C-DF700 Aluminum Canisters.	11 <sup>3</sup> / <sub>16</sub> x 38 <sup>1</sup> / <sub>4</sub> x <sup>15</sup> / <sub>16</sub> inch 284.5 x 971 x 24 mm		P24-DF700

(Continued from last page)

## Stainless Steel Canister Frames

Canister frames are constructed with corrosion resistant stainless steel and include handles.

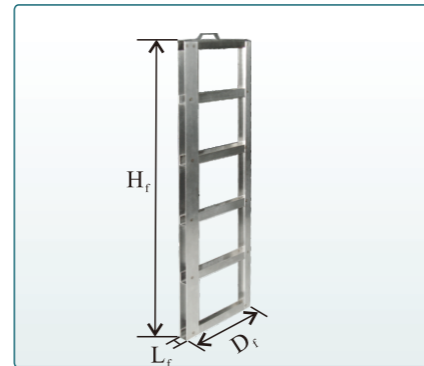

### For STERICON BAGS

Part Number	Blood Bag Number	Description	Dimensions (D x H x L)	Canister	Platform Dividers
F-C-91D-3	RCM-91D	Stainless Steel Frame for 3 STERICON C-91D Aluminum Canisters.	10 <sup>3</sup> / <sub>16</sub> x 17 <sup>3</sup> / <sub>16</sub> x <sup>9</sup> / <sub>16</sub> inch 259 x 440 x 15 mm	C-91D	P20-91D
F-C-91D-4		Stainless Steel Frame for 4 STERICON C-91D Aluminum Canisters.	10 <sup>3</sup> / <sub>16</sub> x 22 <sup>15</sup> / <sub>16</sub> x <sup>9</sup> / <sub>16</sub> inch 259 x 583 x 15 mm		P24-91D
F-C-91D-5		Stainless Steel Frame for 5 STERICON C-91D Aluminum Canisters.	10 <sup>3</sup> / <sub>16</sub> x 28 <sup>9</sup> / <sub>16</sub> x <sup>9</sup> / <sub>16</sub> inch 259 x 726 x 15 mm		P31-91D P39-91D

### For MEDSEP BAGS

Part Number	Blood Bag Number	Description	Dimensions (D x H x L)	Canister	Platform Dividers
F-C-CBBC-V1-6	791-OS 791-OSU 8-0346-O	Stainless Steel Frame for 6 Med Sep CBBC-V1 Aluminum Cord Blood Bag Canisters.	3 <sup>1</sup> / <sub>4</sub> x 23 <sup>3</sup> / <sub>8</sub> x <sup>9</sup> / <sub>16</sub> inch 82 x 587 x 15 mm	CBBC-V1	P20-CBBC-V P24-CBBC-V P31-CBBC-V P39-CBBC-V
F-C-CBBC-V1-7		Stainless Steel Frame for 7 Med Sep CBBC-V1 Aluminum Cord Blood Bag Canisters.	3 <sup>1</sup> / <sub>4</sub> x 26 <sup>7</sup> / <sub>8</sub> x <sup>9</sup> / <sub>16</sub> inch 82 x 683 x 15 mm		
F-C-CBBC-V1-8		Stainless Steel Frame for 8 Med Sep CBBC-V1 Aluminum Cord Blood Bag Canisters.	3 <sup>1</sup> / <sub>4</sub> x 30 <sup>11</sup> / <sub>16</sub> x <sup>9</sup> / <sub>16</sub> inch 82 x 780 x 15 mm		
CF-8-3-T		Stainless Steel Vertical Rack for 56 CBBC-V1 Canisters.	3 <sup>9</sup> / <sub>11</sub> x 25 x 4 <sup>3</sup> / <sub>8</sub> inch 97 x 635 x 111 mm		
CF-9-3-T		Stainless Steel Vertical Rack for 63 CBBC-V1 Canisters.	3 <sup>7</sup> / <sub>11</sub> x 28 <sup>7</sup> / <sub>16</sub> x 4 <sup>3</sup> / <sub>8</sub> inch 97 x 713 x 111 mm		
CF-10-3-T		Stainless Steel Vertical Rack for 70 CBBC-V1 Canisters.	3 <sup>9</sup> / <sub>11</sub> x 31 <sup>1</sup> / <sub>8</sub> x 4 <sup>3</sup> / <sub>8</sub> inch 97 x 791 x 111 mm		

(Continued on next page)

## Aluminum Platform Dividers for Liquid Nitrogen Storage Tanks

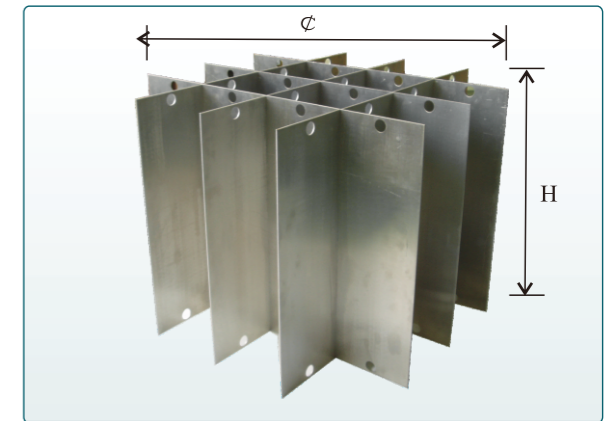

### For BAXTER/FENWAL BAGS

Part Number	Blood Bag Number(S)	Description	Dimensions (H x φ)	Canister	Frames
P20-4R9951	4R-9951	20" diameter Platform Divider for BAXTER/FENWAL bag Canister frames F-C-4R9951.	20 x 20 inch 508 x 508 mm	C-4R9951	F-C-4R9951-5 F-C-4R9951-7 F-C-4R9951-8
P24-4R9951		24" diameter Platform Divider for BAXTER/FENWAL bag Canister frames F-C-4R9951.	20 x 24 inch 508 x 610 mm		
P31-4R9951		31" diameter Platform Divider for BAXTER/FENWAL bag Canister frames F-C-4R9951.	20 x 31 inch 508 x 787 mm		
P39-4R9951		39" diameter Platform Divider for BAXTER/FENWAL bag Canister frames F-C-4R9951.	20 x 39 inch 508 x 991 mm		
P20-4R9953	4R-9953 4R-5461	20" diameter Platform Divider for BAXTER/FENWAL bag Canister frames F-C-4R9953.	20 x 20 inch 508 x 508 mm	C-4R9953	F-C-4R9953-3 F-C-4R9953-4 F-C-4R9953-5
P24-4R9953		24" diameter Platform Divider for BAXTER/FENWAL bag Canister frames F-C-4R9953.	20 x 24 inch 508 x 610 mm		
P31-4R9953		31" diameter Platform Divider for BAXTER/FENWAL bag Canister frames F-C-4R9953.	20 x 31 inch 508 x 787 mm		
P39-4R9953		39" diameter Platform Divider for BAXTER/FENWAL bag Canister frames F-C-4R9953.	20 x 39 inch 508 x 991 mm		
P20-4R9955	4R-9955 4R-5462	20" diameter Platform Divider for BAXTER/FENWAL bag Canister frames F-C-4R9955.	20 x 20 inch 508 x 508 mm	C-4R9955	F-C-4R9955-3 F-C-4R9955-4 F-C-4R9955-5
P24-4R9955		24" diameter Platform Divider for BAXTER/FENWAL bag Canister frames F-C-4R9955.	20 x 24 inch 508 x 610 mm		
P31-4R9955		31" diameter Platform Divider for BAXTER/FENWAL bag Canister frames F-C-4R9955.	20 x 31 inch 508 x 787 mm		
P39-4R9955		39" diameter Platform Divider for BAXTER/FENWAL bag Canister frames F-C-4R9955.	20 x 39 inch 508 x 991 mm		
P20-4R9957	4R-9957 4R-5463	20" diameter Platform Divider for BAXTER/FENWAL bag Canister frames F-C-4R9957.	20 x 20 inch 508 x 508 mm	C-4R9957	F-C-4R9957-3 F-C-4R9957-4 F-C-4R9957-5
P24-4R9957		24" diameter Platform Divider for BAXTER/FENWAL bag Canister frames F-C-4R9957.	20 x 24 inch 508 x 610 mm		
P31-4R9957		31" diameter Platform Divider for BAXTER/FENWAL bag Canister frames F-C-4R9957.	20 x 31 inch 508 x 787 mm		
P39-4R9957		39" diameter Platform Divider for BAXTER/FENWAL bag Canister frames F-C-4R9957.	20 x 39 inch 508 x 991 mm		
P20-4R9959	4R-9959 4R-5464	20" diameter Platform Divider for BAXTER/FENWAL bag Canister frames F-C-4R9959.	20 x 20 inch 508 x 508 mm	C-4R9959	F-C-4R9959-3 F-C-4R9959-4 F-C-4R9959-5
P24-4R9959		24" diameter Platform Divider for BAXTER/FENWAL bag Canister frames F-C-4R9959.	20 x 24 inch 508 x 610 mm		
P31-4R9959		31" diameter Platform Divider for BAXTER/FENWAL bag Canister frames F-C-4R9959.	20 x 31 inch 508 x 787 mm		
P39-4R9959		39" diameter Platform Divider for BAXTER/FENWAL bag Canister frames F-C-4R9959.	20 x 39 inch 508 x 991 mm		

(Continued on next page)

## Aluminum Platform Dividers for Liquid Nitrogen Storage Tanks

(Continued from last page)

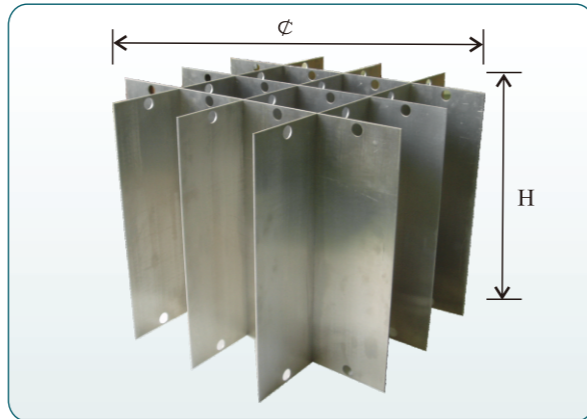

### For BAXTER/FENWAL BAGS

Platform Divider Part Number	Blood Bag Number(S)	Description	Dimension Height x Diameter	Canister	Frames
P20-4R2111	4R-2111	20" diameter Platform Divider for BAXTER/FENWAL bag Canister frames F- C-4R2111.	20 x 20 inch 510 x 510 mm	C-4R2111	F-C-4R2111-3 F-C-4R2111-4
P24-4R2111		24" diameter Platform Divider for BAXTER/FENWAL bag Canister frames F- C-4R2111.	20 x 24 inch 510 x 610 mm		
P31-4R2111		31" diameter Platform Divider for BAXTER/FENWAL bag Canister frames F- C-4R2111.	20 x 31 inch 510 x 787 mm		
P39-4R2111		39" diameter Platform Divider for BAXTER/FENWAL bag Canister frames F- C-4R2111.	20 x 39 inch 510 x 991 mm		
P20-4R2110	4R-2110	20" diameter Platform Divider for BAXTER/FENWAL bag Canister frames F- C-4R2110.	20 x 20 inch 510 x 510 mm	C-4R2110	F-C-4R2110-3 F-C-4R2110-4
P24-4R2110		24" diameter Platform Divider for BAXTER/FENWAL bag Canister frames F- C-4R2110.	20 x 24 inch 510 x 610 mm		
P31-4R2110		31" diameter Platform Divider for BAXTER/FENWAL bag Canister frames F- C-4R2110.	20 x 31 inch 510 x 787 mm		
P39-4R2110		39" diameter Platform Divider for BAXTER/FENWAL bag Canister frames F- C-4R2110.	20 x 39 inch 510 x 991 mm		

### For GAMBRO BAGS

Platform Divider Part Number	Blood Bag Number(S)	Description	Dimension Height x Diameter	Canister	Frames
P20-DF200	DF-200	20" diameter Platform Divider for GAMBRO bag Canister frames F-C-DF-200.	20 x 20 inch 510 x 510 mm	C-DF-200	F-C DF200-4 F-C DF200-6
P24-DF200		24" diameter Platform Divider for GAMBRO bag Canister frames F-C-DF-200.	20 x 24 inch 510 x 610 mm		
P31-DF200		31" diameter Platform Divider for GAMBRO bag Canister frames F-C-DF-200.	20 x 31 inch 510 x 787 mm		
P39-DF200		39" diameter Platform Divider for GAMBRO bag Canister frames F-C-DF-200.	20 x 39 inch 510 x 991 mm		
P20-DF700	DF-700	20" diameter Platform Divider for GAMBRO bag Canister frames F-C-DF-700.	20 x 20 inch 510 x 510 mm	C-DF-700	F-C DF700-4 F-C DF700-6
P24-DF700		24" diameter Platform Divider for GAMBRO bag Canister frames F-C-DF-700.	20 x 24 inch 510 x 610 mm		
P31-DF700		31" diameter Platform Divider for GAMBRO bag Canister frames F-C-DF-700.	20 x 31 inch 510 x 787 mm		
P39-DF700		39" diameter Platform Divider for GAMBRO bag Canister frames F-C-DF-700.	20 x 39 inch 510 x 991 mm		

(Continued on next page)

## Aluminum Platform Dividers for Liquid Nitrogen Storage Tanks

(Continued from last page)

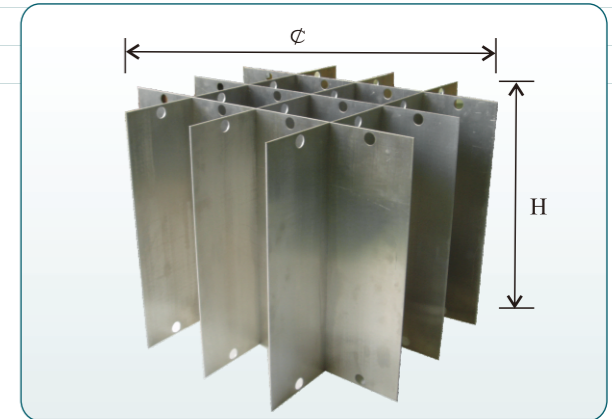

### For CHARTERED BAGS

Platform Divider Part Number	Blood Bag Number(S)	Description	Dimension Height x Diameter	Canister	Frames
P20-7120	7120-2	20" diameter Platform Divider for CHARTERED bag Canister frames F- C-7120.	20 x 20 inch 510 x 510 mm	C-7120	F-C-7120-4 F-C-7120-5 F-C-7120-6
P24-7120		24" diameter Platform Divider for CHARTERED bag Canister frames F- C-7120.	20 x 24 inch 510 x 610 mm		
P31-7120		31" diameter Platform Divider for CHARTERED bag Canister frames F- C-7120.	20 x 31 inch 510 x 787 mm		
P39-7120		39" diameter Platform Divider for CHARTERED bag Canister frames F- C-7120.	20 x 39 inch 510 x 991 mm		
P20-7005	7005-2 7303-2 7039-2	20" diameter Platform Divider for CHARTERED bag Canister frames F-7005.	20 x 20 inch 510 x 510 mm	C-7005	F-C-7005-2 F-C-7005-3
P24-7005		24" diameter Platform Divider for CHARTERED bag Canister frames F-7005.	20 x 24 inch 510 x 610 mm		
P31-7005		31" diameter Platform Divider for CHARTERED bag Canister frames F- C-7005.	20 x 31 inch 510 x 787 mm		
P39-7005		39" diameter Platform Divider for CHARTERED bag Canister frames F- C7005.	20 x 39 inch 510 x 991 mm		
P20-7400	7400-2 7403-2 7410-2 7025-2	20" diameter Platform Divider for CHARTERED bag Canister frames F- C-7400.	20 x 20 inch 510 x 510 mm	C-7400	F-C-7400-2
P24-7400		24" diameter Platform Divider for CHARTERED bag Canister frames F- C-7400.	20 x 24 inch 510 x 610 mm		
P31-7400		31" diameter Platform Divider for CHARTERED bag Canister frames F- C-7400.	20 x 31 inch 510 x 787 mm		
P39-7400		39" diameter Platform Divider for CHARTERED bag Canister frames F- C7400.	20 x 39 inch 510 x 991 mm		
P20-DF200		20" diameter Platform Divider for CHARTERED bag Canister frames	20 x 20 inch 510 x 510 mm		
P24-DF200		24" diameter Platform Divider for CHARTERED bag Canister frames F-7005.	20 x 24 inch 510 x 610 mm		
P31-DF200		31" diameter Platform Divider for CHARTERED bag Canister frames	20 x 31 inch 510 x 787 mm		
P39-DF200		39" diameter Platform Divider for CHARTERED bag Canister frames	20 x 39 inch 510 x 991 mm		
P20-DF700		20" diameter Platform Divider for CHARTERED bag Canister frames	20 x 20 inch 510 x 510 mm		
P24-DF700		24" diameter Platform Divider for CHARTERED bag Canister frames F-7005.	20 x 24 inch 510 x 610 mm		
P31-DF700		31" diameter Platform Divider for CHARTERED bag Canister frames	20 x 31 inch 510 x 787 mm		
P39-DF700		39" diameter Platform Divider for CHARTERED bag Canister frames	20 x 39 inch 510 x 991 mm		



# Aluminum Platform Dividers for Liquid Nitrogen Storage Tanks

(Continued from last page)

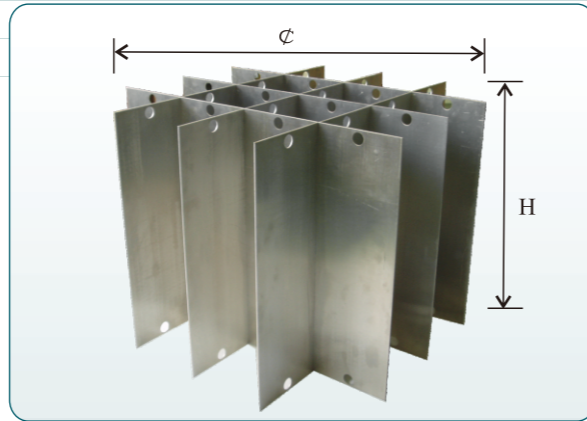

## For STERICON BAGS

Platform Divider Part Number	Blood Bag Number(S)	Description	Dimension Height x Diameter	Canister	Frames
P20-91D	RCM-91D	20" diameter Platform Divider for STERICON bag Canister frames F-C-91D.	20 x 20 inch 510 x 510 mm	C-91D	F-C 91D-3 F-C 91D-4 F-C 91D-5
P24-91D		24" diameter Platform Divider for STERICON bag Canister frames F-C-91D.	20 x 24 inch 510 x 610 mm		
P31-91D		31" diameter Platform Divider for STERICON bag Canister frames F-C-91D.	20 x 31 inch 510 x 787 mm		
P39-91D		39" diameter Platform Divider for STERICON bag Canister frames F-C-91D.	20 x 39 inch 510 x 991 mm		

## For MED SEP BAGS

Platform Divider Part Number	Blood Bag Number(S)	Description	Dimension Height x Diameter	Canister	Fames
P20-CBBC-V1	791-OS 791-OSU 8-0346-O	20" diameter Platform Divider for MED SEP bag Canister frames F-CBBC-V1.	20 x 20 inch 510 x 510 mm	CBBC-V1	F-C-CBBC-V1-6 F-C-CBBC-V1-7 F-C-CBBC-V1-8
P24-CBBC-V1		24" diameter Platform Divider for MED SEP bag Canister frames F-CBBC-V1.	20 x 24 inch 510 x 610 mm		
P31-CBBC-V1		31" diameter Platform Divider for MED SEP bag Canister frames F-CBBC-V1.	20 x 31 inch 510 x 787 mm		
P39-CBBC-V1		39" diameter Platform Divider for MED SEP bag Canister frames F-CBBC-V1.	20 x 39 inch 510 x 991 mm		

# Cross Reference Tables for Blood Bag Storage Systems for Most Popular Liquid Nitrogen Storage Tanks

## CHART-MVE ETERNE/HE SERIES

Frame Part Number (total frames total canisters)	BAXTER/FENWAL BAG NUMBER(S)						
	Bag Manufacturer	4R-9951	4R-9953 4R-5461	4R-9955 4R-5462	4R-9957 4R-5464	4R-9959 4R-5464	4R-2111 4R-2110
	Canister Part Number	C-4R9951	C-4R9953	C-4R9955	C-4R9957	C-4R9959	C-4R2111 C-4R2110
MVE 810HE/MVE-815P-150	F-C-4R9951-5(111/555) F-C-4R9951-7(111/777) F-C-4R9951-8(111/888)	F-C-4R9953-3(95/285) F-C-4R9953-4(95/380) F-C-4R9953-5(95/475)	F-C-4R9955-3(68/204) F-C-4R9955-4(68/272) F-C-4R9955-5(68/340)	F-C-4R9957-3(68/204) F-C-4R9957-4(68/272)		F-C-4R2111-3(44/132) F-C-4R2111-4(44/176)	F-C-4R2110-3(42/126)
MVE 1520HE/MVE-1536P-150	F-C-4R9951-5(248/1240) F-C-4R9951-7(248/1736) F-C-4R9951-8(248/1984)	F-C-4R9953-3(190/570) F-C-4R9953-4(190/760) F-C-4R9953-5(190/950)	F-C-4R9955-3(180/540) F-C-4R9955-4(180/720) F-C-4R9955-5(180/900)	F-C-4R9957-3(130/390) F-C-4R9957-4(130/520)	F-C-4R9959-3(96/288) F-C-4R9959-4(96/384)	F-C-4R2111-3(92/276) F-C-4R2111-4(92/368)	F-C-4R2110-3(80/240)
MVE1830HE/MVE-1892P-150	F-C-4R9951-5(480/2400) F-C-4R9951-7(480/3360) F-C-4R9951-8(480/3840)	F-C-4R9953-3(390/1170) F-C-4R9953-4(390/1560) F-C-4R9953-5(390/1950)	F-C-4R9955-3(276/828) F-C-4R9955-4(276/1104) F-C-4R9955-5(276/1380)	F-C-4R9957-3(240/720) F-C-4R9957-4(240/960)	F-C-4R9959-3(174/522) F-C-4R9959-4(174/696)	F-C-4R2111-3(180/540) F-C-4R2111-4(180/720)	F-C-4R2110-3(150/450)

Frame Part Number (total frames total canisters)	CHARTERMED		GAMBRO		STERICON	MED SEP		
	Bag Manufacturer	7120-2	7005-2 7303-2 7039-2	7400-2 7403-2 7410-2 7025-2	DF-200	DF-700	RCM-91D	791-05 791-05U 8-0346-0
	Canister Part Number	C-7120	C-7005	C-7400	C-DF-200	C-DF-700	C-91D	CBBC-V1
MVE 810HE/MVE-815P-150	F-C-7120-4(154/616) F-C-7120-5(154/770) F-C-7120-6(154/924)	F-C-7005-2(72/144) F-C-7005-3(72/216)	F-C-7400-2(82/164) F-C-7400-3(82/246)	F-C-DF200-4(52/108) F-C-DF200-6(52/312)	F-C-DF700-3(34/102) F-C-DF700-4(34/136)	F-C-91D-3(68/204) F-C-91D-4(68/272)	F-C-CBBC-V1-6(138/828) F-C-CBBC-V1-7(138/966) CF-9-3-T(26/1456)	
MVE 1520HE/MVE-1536P-150	F-C-7120-4(350/1400) F-C-7120-5(350/1750) F-C-7120-6(350/2100)	F-C-7005-2(152/304) F-C-7005-3(152/456)	F-C-7400-2(150/300) F-C-7400-3(150/450)	F-C-DF200-4(104/416) F-C-DF200-6(104/624)	F-C-DF700-3(72/216) F-C-DF700-4(72/288)	F-C-91D-3(130/390) F-C-91D-4(130/520)	F-C-CBBC-V1-6(428/2568) F-C-CBBC-V1-7(428/2996) CF-9-3-T(52/3276)	
MVE1830HE/MVE-1892P-150	F-C-7120-4(594/2376) F-C-7120-5(594/2970) F-C-7120-6(594/3560)	F-C-7005-2(306/612) F-C-7005-3(306/918)	F-C-7400-2(294/588) F-C-7400-3(294/882)	F-C-DF200-4(198/792) F-C-DF200-6(198/1188)	F-C-DF700-3(126/378) F-C-DF700-4(126/504)	F-C-91D-3(240/720) F-C-91D-4(240/960)	F-C-CBBC-V1-6(881/5286) F-C-CBBC-V1-7(881/6167) CF-9-3-T(108/6804)	

## CHART MVE 600/1400 SERIES

Frame Part Number (total frames total canisters)	BAXTER/FENWAL BAG NUMBER(S)						
	Bag Manufacturer	4R-9951	4R-9953 4R-5461	4R-9955 4R-5462	4R-9957 4R-5464	4R-9959 4R-5464	4R-2111 4R-2110
	Canister Part Number	C-4R9951	C-4R9953	C-4R9955	C-4R9957	C-4R9959	C-4R2111 C-4R2110
MVE 600/MVE-616C	F-C-4R9951-5(88/440) F-C-4R9951-7(88/616)	F-C-4R9953-3(66/198) F-C-4R9953-4(66/264) F-C-4R9953-5(66/330)	F-C-4R9955-3(56/168) F-C-4R9955-4(56/224) F-C-4R9955-5(56/280)	F-C-4R9957-3(46/138) F-C-4R9957-4(46/184) F-C-4R9957-5(46/230)	F-C-4R9959-3(36/108) F-C-4R9959-4(36/144) F-C-4R9959-5(36/180)	F-C-4R2111-3(28/84) F-C-4R2111-4(28/112)	F-C-4R2110-3(25/75)
MVE 1400/MVE-1426CF	F-C-4R9951-5(120/600) F-C-4R9951-7(120/840)	F-C-4R9953-3(112/336) F-C-4R9953-4(112/448) F-C-4R9953-5(112/560)	F-C-4R9955-3(94/282) F-C-4R9955-4(94/376) F-C-4R9955-5(94/470)	F-C-4R9957-3(84/252) F-C-4R9957-4(84/336) F-C-4R9957-5(84/420)	F-C-4R9959-3(57/171) F-C-4R9959-4(57/228) F-C-4R9959-5(57/285)	F-C-4R2111-3(56/168) F-C-4R2111-4(56/224)	F-C-4R2110-3(25/75)

Frame Part Number (total frames total canisters)	CHARTERMED		GAMBRO		STERICON	MED SEP		
	Bag Manufacturer	7120-2	7005-2 7303-2 7039-2	7400-2 7403-2 7410-2 7025-2	DF-200	DF-700	RCM-91D	791-05 791-05U 8-0346-0
	Canister Part Number	C-7120	C-7005	C-7400	C-DF-200	C-DF-700	C-91D	CBBC-V1
MVE 600/MVE-616C	F-C-7120-4(88/352) F-C-7120-5(88/440) F-C-7120-6(88/528)	F-C-7005-2(48/96) F-C-7005-3(48/144)	F-C-7400-2(48/96) F-C-7400-3(48/144)	F-C-DF200-4(28/112) F-C-DF200-6(28/168)	F-C-DF700-4(24/96) F-C-DF700-6(24/144)	F-C-91D-3(46/138) F-C-91D-4(46/184) F-C-91D-5(46/230)	F-C-CBBC-V1-6(138/828) F-C-CBBC-V1-7(138/966) CF-9-3-T(22/1386)	
MVE 1400/MVE-1426CF	F-C-7120-4(148/592) F-C-7120-5(148/740) F-C-7120-6(148/888)	F-C-7005-2(96/192) F-C-7005-3(96/288)	F-C-7400-2(96/192) F-C-7400-3(96/288)	F-C-DF200-4(60/240) F-C-DF200-6(60/360)	F-C-DF700-4(40/160) F-C-DF700-6(40/240)	F-C-91D-3(84/252) F-C-91D-4(84/336) F-C-91D-5(84/420)	F-C-CBBC-V1-6(232/1392) F-C-CBBC-V1-7(232/1624) CF-9-3-T(35/2205)	

(Continued on next page)

(Continued on next page)

# Cross Reference Tables for Blood Bag Storage Systems for Most Popular Liquid Nitrogen Storage Tanks

## CHART MVE SERIES

Bag Manufacturer Frame Part Number (total frames total canisters) Canister Part Number	BAXTER/FENWAL BAG NUMBER(S)						
	4R-9951	4R-9953 4R-5461	4R-9955 4R-5462	4R-9957 4R-5464	4R-9959 4R-5464	4R-2111	4R-2110
	C-4R9951	C-4R9953	C-4R9955	C-4R9957	C-4R9959	C-4R2111	C-4R2110
Tank Model Number Old/New							
MVE 230/MVE-204	F-C-4R9951-5(36/180) F-C-4R9951-7(36/252)	F-C-4R9953-3(29/87) F-C-4R9953-5(29/145)	F-C-4R9955-3(21/63) F-C-4R9955-4(21/84) F-C-4R9955-5(21/105)	F-C-4R9957-3(18/54) F-C-4R9957-4(18/72) F-C-4R9957-5(18/90)	F-C-4R9959-3(13/39) F-C-4R9959-4(13/52) F-C-4R9959-5(13/65)	F-C-4R2111-3(16/48) F-C-4R2111-4(16/64)	F-C-4R2110-3(13/39) F-C-4R2110-4(13/52)
MVE 230II/MVE-205	F-C-4R9951-5(36/180) F-C-4R9951-7(36/252)	F-C-4R9953-3(29/87) F-C-4R9953-4(29/116) F-C-4R9953-5(29/145)	F-C-4R9955-3(21/63) F-C-4R9955-4(21/84) F-C-4R9955-5(21/105)	F-C-4R9957-3(18/54) F-C-4R9957-4(18/72) F-C-4R9957-5(18/90)	F-C-4R9959-3(13/39) F-C-4R9959-4(13/52) F-C-4R9959-5(13/65)	F-C-4R2111-3(16/48) F-C-4R2111-4(16/64)	F-C-4R2110-3(13/39) F-C-4R2110-4(13/52)
MVE 511/MVE-510	F-C-4R9951-5(36/180) F-C-4R9951-7(36/252)	F-C-4R9953-3(29/87) F-C-4R9953-4(29/116) F-C-4R9953-5(29/145)	F-C-4R9955-3(21/63) F-C-4R9955-4(21/84) F-C-4R9955-5(21/105)	F-C-4R9957-3(18/54) F-C-4R9957-4(18/72) F-C-4R9957-5(18/90)	F-C-4R9959-3(13/39) F-C-4R9959-4(13/52) F-C-4R9959-5(13/65)	F-C-4R2111-3(16/48) F-C-4R2111-4(16/64)	F-C-4R2110-3(13/39) F-C-4R2110-4(13/52)
Platform Divider Part No. (For MVE 511/MVE-510)	P20-4R9951	P20-4R9953	P20-4R9955	P20-4R9957	P20-4R9959	P20-4R2111	P20-4R2110
MVE 611/MVE-616	F-C-4R9951-5(88/440) F-C-4R9951-7(88/616)	F-C-4R9953-3(66/198) F-C-4R9953-4(66/264) F-C-4R9953-5(66/330)	F-C-4R9955-3(56/168) F-C-4R9955-4(56/224) F-C-4R9955-5(56/280)	F-C-4R9957-3(46/138) F-C-4R9957-4(46/184) F-C-4R9957-5(46/230)	F-C-4R9959-3(36/108) F-C-4R9959-4(36/144) F-C-4R9959-5(36/180)	F-C-4R2111-3(28/84) F-C-4R2111-4(28/112)	F-C-4R2110-3(25/75) F-C-4R2110-4(25/100)
Platform Divider Part No. (For MVE 611/MVE-616)	P24-4R9951	P24-4R9953	P24-4R9955	P24-4R9957	P24-4R9959	P24-4R2111	P24-4R2110
MVE 1411/MVE-1426	F-C-4R9951-5(20/100) F-C-4R9951-7(20/140)	F-C-4R9953-3(112/336) F-C-4R9953-4(112/448) F-C-4R9953-5(112/560)	F-C-4R9955-3(94/282) F-C-4R9955-4(94/376) F-C-4R9955-5(94/470)	F-C-4R9957-3(84/252) F-C-4R9957-4(84/336) F-C-4R9957-5(84/420)	F-C-4R9959-3(57/171) F-C-4R9959-4(57/228) F-C-4R9959-5(57/285)	F-C-4R2111-3(56/168) F-C-4R2111-4(56/224)	F-C-4R2110-3(52/156) F-C-4R2110-4(52/208)
Platform Divider Part No. (For MVE 1411/MVE-1426)	P24-4R9951	P24-4R9953	P24-4R9955	P24-4R9957	P24-4R9959	P24-4R2111	P24-4R2110
MVE 1841/MVE-1839	F-C-4R9951-5(210/1050) F-C-4R9951-7(210/1470) F-C-4R9951-8(210/1680)	F-C-4R9953-3(156/468) F-C-4R9953-4(156/624) F-C-4R9953-5(156/780)	F-C-4R9955-3(144/432) F-C-4R9955-4(144/576) F-C-4R9955-5(144/720)	F-C-4R9957-3(116/408) F-C-4R9957-4(116/544) F-C-4R9957-5(116/680)	F-C-4R9959-3(106/318) F-C-4R9959-4(106/424) F-C-4R9959-5(106/530)	F-C-4R2111-3(92/276) F-C-4R2111-4(92/368)	F-C-4R2110-3(81/243) F-C-4R2110-4(81/324)
Platform Divider Part No. (For MVE 1841/MVE-1839)	P39-4R9951	P39-4R9953	P39-4R9955	P39-4R9957	P39-4R9959	P39-4R2111	P39-4R2110

Bag Manufacturer Frame Part Number (total frames total canisters) Canister Part Number	CHARTERMED		GAMBRO		STERICON	MED SEP
	7120-2	7005-2 7303-2 7039-2	7400-2 7403-2 7410-2 7025-2	DF-200	DF-700	RCM-91D
	C-7120	C-7005	C-7400	C-DF-200	C-DF-700	C-91D
Tank Model Number						
MVE 230/MVE-204	F-C-7120-4(48/192) F-C-7120-5(48/240) F-C-7120-6(48/288)	F-C-7005-2(24/48) F-C-7005-3(24/72)	F-C-7400-2(24/48)	F-C-DF200-4(16/64)		F-C-91D-3(18/54)
MVE 230II/MVE-205	F-C-7120-4(48/192) F-C-7120-5(48/240) F-C-7120-6(48/288)	F-C-7005-2(24/48) F-C-7005-3(24/72)	F-C-7400-2(24/48) F-C-7400-3(24/72)	F-C-DF200-4(24/96) F-C-DF200-6(24/144)	F-C-DF700-3(10/30) F-C-DF700-4(10/40)	F-C-91D-3(18/54) F-C-91D-4(18/72) F-C-91D-5(18/90)
MVE 511/MVE-510	F-C-7120-4(58/232) F-C-7120-5(58/290) F-C-7120-6(58/348)	F-C-7005-2(40/80) F-C-7005-3(40/120)	F-C-7400-2(40/80) F-C-7400-3(40/120)	F-C-DF200-4(20/80) F-C-DF200-6(20/120)	F-C-DF700-3(16/48) F-C-DF700-4(16/64)	F-C-91D-3(30/90) F-C-91D-4(30/120) F-C-91D-5(30/150)
Platform Divider Part No. (For MVE 511/MVE-510)	P20-7120	P20-7005	P20-7400	P20-DF200	P20-DF700	P20-91D
MVE 611/MVE-616	F-C-7120-4(88/352) F-C-7120-5(88/440) F-C-7120-6(88/528)	F-C-7005-2(48/96) F-C-7005-3(48/144)	F-C-7400-2(48/96) F-C-7400-3(48/144)	F-C-DF200-4(28/112) F-C-DF200-6(28/168)	F-C-DF700-3(24/96) F-C-DF700-4(24/96)	F-C-91D-3(46/138) F-C-91D-4(46/184) F-C-91D-5(46/230)
Platform Divider Part No. (For MVE 611/MVE-616)	P24-7120	P24-7005	P24-7400	P24-DF200	P24-DF700	P24-91D
MVE 1411/MVE-1426	F-C-7120-4(148/592) F-C-7120-5(148/740) F-C-7120-6(148/888)	F-C-7005-2(96/192) F-C-7005-3(96/288)	F-C-7400-2(96/192) F-C-7400-3(96/288)	F-C-DF200-4(60/240) F-C-DF200-6(60/360)	F-C-DF700-3(40/120) F-C-DF700-4(40/160)	F-C-91D-3(84/252) F-C-91D-4(84/336) F-C-91D-5(84/420)
Platform Divider Part No. (For MVE 1411/MVE-1426)	P24-7120	P24-7005	P24-7400	P24-DF200	P24-DF700	P24-91D
MVE 1841/MVE-1839	F-C-7120-4(256/1024) F-C-7120-5(256/1280) F-C-7120-6(256/1536)	F-C-7005-2(148/296) F-C-7005-3(148/444)	F-C-7400-2(148/296) F-C-7400-3(148/444)	F-C-DF200-4(92/368) F-C-DF200-6(92/552)	F-C-DF700-3(68/204) F-C-DF700-4(68/272)	F-C-91D-3(136/408) F-C-91D-4(136/544) F-C-91D-5(136/680)
Platform Divider Part No. (For MVE 1841/MVE-1839)	P39-7120	P39-7005	P39-7400	P39-DF200	P39-DF700	P39-91D

(Continued on next page)

# Cross Reference Tables for Blood Bag Storage Systems for Most Popular Liquid Nitrogen Storage Tanks

## CHART MVE Bio Series

Bag Manufacturer Frame Part Number (total frames total canisters) Canister Part Number	BAXTER/FENWAL BAG NUMBER(S)						
	4R-9951	4R-9953 4R-5461	4R-9955 4R-5462	4R-9957 4R-5464	4R-9959 4R-5464	4R-2111	4R-2110
	C-4R9951	C-4R9953	C-4R9955	C-4R9957	C-4R9959	C-4R2111	C-4R2110
Tank Model Number Old/New							
BIO I	F-C-4R9951-5(36/180) F-C-4R9951-7(36/252)	F-C-4R9953-3(29/87) F-C-4R9953-4(26/116)	F-C-4R9955-3(21/63) F-C-4R9955-4(21/84)	F-C-4R9957-3(18/54) F-C-4R9957-4(18/72)	F-C-4R9959-3(13/39) F-C-4R9959-4(13/52)	F-C-4R2111-4(16/64)	F-C-4R2110-3(13/39)
BIO II	F-C-4R9951-5(56/280) F-C-4R9951-7(56/392)	F-C-4R9953-3(43/129) F-C-4R9953-4(43/172)	F-C-4R9955-3(32/96) F-C-4R9955-4(32/128)	F-C-4R9957-3(30/90) F-C-4R9957-4(30/120)	F-C-4R9959-3(21/63) F-C-4R9959-4(21/84)	F-C-4R2111-3(20/60) F-C-4R2111-4(20/80)	F-C-4R2110-3(18/54)
Platform Divider Part No. (For MVE BIO II)	P20-4R9951	P20-4R9953	P20-4R9955	P20-4R9957	P20-4R9959	P20-4R2111	P20-4R2110
BIO III	F-C-4R9951-5(72/360) F-C-4R9951-7(72/504)	F-C-4R9953-3(66/198) F-C-4R9953-4(66/264) F-C-4R9953-5(66/330)	F-C-4R9955-3(48/144) F-C-4R9955-4(48/192) F-C-4R9955-5(48/240)	F-C-4R9957-3(46/138) F-C-4R9957-4(46/184) F-C-4R9957-5(46/230)	F-C-4R9959-3(36/108) F-C-4R9959-4(36/144) F-C-4R9959-5(36/180)	F-C-4R2111-3(28/84) F-C-4R2111-4(28/112)	F-C-4R2110-3(25/75) F-C-4R2110-4(25/100)
Platform Divider Part No. (For MVE BIO III)	P24-4R9951	P24-4R9953	P24-4R9955	P24-4R9957	P24-4R9959	P24-4R2111	P24-4R2110
BIO IV	F-C-4R9951-5(120/600) F-C-4R9951-7(120/840) F-C-4R9951-8(120/960)	F-C-4R9953-3(108/324) F-C-4R9953-4(108/432) F-C-4R9953-5(108/540)	F-C-4R9955-3(88/264) F-C-4R9955-4(88/352) F-C-4R9955-5(88/440)	F-C-4R9957-3(70/210) F-C-4R9957-4(70/280) F-C-4R9957-5(70/350)	F-C-4R9959-3(57/171) F-C-4R9959-4(57/228) F-C-4R9959-5(57/285)	F-C-4R2111-3(56/168) F-C-4R2111-4(56/224)	F-C-4R2110-3(52/156) F-C-4R2110-4(52/208)
Platform Divider Part No. (For MVE BIO IV)	P31-4R9951	P31-4R9953	P31-4R9955	P31-4R9957	P31-4R9959	P31-4R2111	P31-4R2110
BIO V	F-C-4R9951-5(210/1050) F-C-4R9951-7(210/1470) F-C-4R9951-8(210/1680)	F-C-4R9953-3(156/468) F-C-4R9953-4(156/624) F-C-4R9953-5(156/780)	F-C-4R9955-3(144/432) F-C-4R9955-4(144/576) F-C-4R9955-5(144/720)	F-C-4R9957-3(116/408) F-C-4R9957-4(116/544) F-C-4R9957-5(116/680)	F-C-4R9959-3(106/318) F-C-4R9959-4(106/424) F-C-4R9959-5(106/530)	F-C-4R2111-3(92/276) F-C-4R2111-4(92/368)	F-C-4R2110-3(81/243) F-C-4R2110-4(81/324)
Platform Divider Part No. (For MVE BIO V)	P39-4R9951	P39-4R9953	P39-4R9955	P39-4R9957	P39-4R9959	P39-4R2111	P39-4R2110

Bag Manufacturer Frame Part Number (total frames total canisters) Canister Part Number	CHARTERMED		GAMBRO		STERICON	MED SEP
	7120-2	7005-2 7303-2 7039-2	7400-2 7403-2 7410-2 7025-2	DF-200	DF-700	RCM-91D
	C-7120	C-7005	C-7400	C-DF-200	C-DF-700	C-91D
Tank Model Number Old/New						
BIO I	F-C-7120-4(48/192) F-C-7120-5(48/240) F-C-7120-6(48/288)	F-C-7005-2(24/48) F-C-7005-3(24/72)	F-C-7400-2(24/48)	F-C-DF200-4(24/96) F-C-DF200-6(24/144)	F-C-DF700-3(10/30) F-C-DF700-4(10/40)	F-C-91D-3(18/54) F-C-91D-4(18/72)
BIO II	F-C-7120-4(58/232) F-C-7120-5(58/290) F-C-7120-6(58/348)	F-C-7005-2(40/80) F-C-7005-3(40/120)	F-C-7400-2(40/80) F-C-7400-3(40/120)	F-C-DF200-4(20/80) F-C-DF200-6(20/120)	F-C-DF700-3(16/48) F-C-DF700-4(16/64)	F-C-91D-3(30/90) F-C-91D-4(30/120) F-C-91D-5(30/150)
Platform Divider Part No. (For MVE BIO II)	P20-7120	P20-7005	P20-7400	P20-DF200	P20-DF700	P20-91D
BIO III	F-C-7120-4(88/352) F-C-7120-5(88/440) F-C-7120-6(88/528)	F-C-7005-2(48/96) F-C-7005-3(48/144)	F-C-7400-2(48/96) F-C-7400-3(48/144)	F-C-DF200-4(28/112) F-C-DF200-6(28/168)	F-C-DF700-3(24/96) F-C-DF700-4(24/96)	F-C-91D-3(46/138) F-C-91D-4(46/184) F-C-91D-5(46/230)
Platform Divider Part No. (For MVE BIO III)	P24-7120	P24-7005	P24-7400	P24-DF200	P24-DF700	P24-91D
BIO IV	F-C-7120-4(152/608) F-C-7120-5(152/760) F-C-7120-6(152/912)	F-C-7005-2(96/192) F-C-7005-3(96/288)	F-C-7400-2(96/192) F-C-7400-3(96/288)	F-C-DF200-4(56/224) F-C-DF200-6(56/336)	F-C-DF700-3(40/120) F-C-DF700-4(40/160)	F-C-91D-3(80/240) F-C-91D-4(80/320) F-C-91D-5(80/400)
Platform Divider Part No. (For MVE BIO IV)	P31-7120	P31-7005	P31-7400	P31-DF200	P31-DF700	P31-91D
BIO V	F-C-7120-4(256/1024) F-C-7120-5(256/1280) F-C-7120-6(256/1536)	F-C-7005-2(148/296) F-C-7005-3(148/444)	F-C-7400-2(148/296) F-C-7400-3(148/444)	F-C-DF200-4(92/368) F-C-DF200-6(92/552)	F-C-DF700-3(68/204) F-C-DF700-4(68/272)	F-C-91D-3(136/408) F-C-91D-4(136/544) F-C-91D-5(136/680)
Platform Divider Part No. (For MVE BIO V)	P39-7120	P39-7005	P39-7400	P39-DF200	P39-DF700	P39-91D

## TAYLOR-WHARTON LABS SERIES

Bag Manufacturer Frame Part Number (total frames total canisters) Canister Part Number	BAXTER/FENWAL BAG NUMBER(S)						
	4R-9951	4R-9953 4R-5461	4R-9955 4R-5462	4R-9957 4R-5464	4R-9959 4R-5464	4R-2111	4R-2110
	C-4R9951	C-4R9953	C-4R9955	C-4R9957	C-4R9959	C-4R2111	C-4R2110
Tank Model Number							
20K	F-C-4R9951-5(108/540) F-C-4R9951-7(108/756) F-C-4R9951-8(108/864)	F-C-4R9953-3(72/216) F-C-4R9953-4(72/288) F-C-4R9953-5(72/360)	F-C-4R9955-3(54/162) F-C-4R9955-4(54/216) F-C-4R9955-5(54/270)	F-C-4R9957-3(68/204) F-C-4R9957-4(68/272) F-C-4R9957-5(68/336)		F-C-4R2111-3(50/150) F-C-4R2111-4(50/200)	F-C-4R2110-3(44/132)
40K	F-C-4R9951-5(216/1080) F-C-4R9951-7(216/1512) F-C-4R9951-8(216/1728)	F-C-4R9953-3(174/522) F-C-4R9953-4(174/700) F-C-4R9953-5(174/870)	F-C-4R9955-3(118/354) F-C-4R9955-4(118/472) F-C-4R9955-5(118/590)	F-C-4R9957-3(96/288) F-C-4R9957-4(96/384) F-C-4R9957-5(96/480)	F-C-4R9959-3(72/216) F-C-4R9959-4(72/288) F-C-4R9959-5(72/360)	F-C-4R2111-3(90/270) F-C-4R2111-4(	

# Cross Reference Tables for Blood Bag Storage Systems for Most Popular Liquid Nitrogen Storage Tanks

Frame Part Number (total frames total canisters)	Bag Manufacturer						
	7120-2	7005-2 7303-2 7039-2	7400-2 7403-2 7410-2 7025-2	DF-200	DF-700	RCM-91D	791-05 791-05U 8-0346-0
Tank Model Number	C-7120	C-7005	C-7400	C-DF-200	C-DF-700	C-91D	CBBC-V1
20K	F-C-4R7120-4(124/496) F-C-4R7120-5(124/620) F-C-4R7120-6(124/744)	F-C-4R7005-2(56/112) F-C-4R7005-3(56/168)	F-C-4R7400-2(56/112) F-C-4R7400-3(56/168)	F-C-DF200-4(48/384) F-C-DF200-6(48/576)	F-C-DF700-3(38/114) F-C-DF700-4(38/152)	F-C-91D-3(68/204) F-C-91D-4(68/272) F-C-91D-5(68/336)	F-C-CBBC-V1-6(198/1188) F-C-CBBC-V1-7(198/1386) CF-9-3-T(26/1638)
40K	F-C-4R7120-4(288/1152) F-C-4R7120-5(288/1440) F-C-4R7120-6(288/1728)	F-C-4R7005-2(138/276) F-C-4R7005-3(138/414)	F-C-4R7400-2(138/276) F-C-4R7400-3(138/414)	F-C-DF200-4(96/768) F-C-DF200-6(96/1152)	F-C-DF700-3(54/162) F-C-DF700-4(54/216)	F-C-91D-3(96/288) F-C-91D-4(96/384) F-C-91D-5(96/480)	F-C-CBBC-V1-6(402/2412) F-C-CBBC-V1-7(402/2814) CF-9-3-T(56/3528)
80K	F-C-4R7120-4(570/2280) F-C-4R7120-5(570/2850) F-C-4R7120-6(570/3420)	F-C-4R7005-2(294/588) F-C-4R7005-3(294/882)	F-C-4R7400-2(294/588) F-C-4R7400-3(294/882)	F-C-DF200-4(192/1536) F-C-DF200-6(192/2304)	F-C-DF700-3(126/378) F-C-DF700-4(126/504)	F-C-91D-3(228/684) F-C-91D-4(228/912) F-C-91D-5(228/1140)	F-C-CBBC-V1-6(780/4680) F-C-CBBC-V1-7(780/5460) CF-9-3-T(112/7056)

## TAYLOR-WHARTON K SERIES

Frame Part Number (total frames total canisters)	BAXTER/FENWAL BAG NUMBER(S)						
	4R-9951	4R-9953 4R-5461	4R-9955 4R-5462	4R-9957 4R-5464	4R-9959 4R-5464	4R-2111	4R-2110
Tank Model Number	C-4R9951	C-4R9953	C-4R9955	C-4R9957	C-4R9959	C-4R2111	C-4R2110
3K	F-C-4R9951-5(25/125)	F-C-4R9953-3(20/60)	F-C-4R9955-3(14/42)	F-C-4R9957-3(8/24)	F-C-4R9959-3(2/6)		
10K	F-C-4R9951-5(56/280) F-C-4R9951-7(56/392)	F-C-4R9953-3(43/129) F-C-4R9953-4(43/172) F-C-4R9953-5(43/215)	F-C-4R9955-3(32/96) F-C-4R9955-4(32/128) F-C-4R9955-5(32/160)	F-C-4R9957-3(30/90) F-C-4R9957-4(30/120) F-C-4R9957-5(30/150)	F-C-4R9959-3(21/63) F-C-4R9959-4(21/84) F-C-4R9959-5(21/105)	F-C-4R2111-3(20/60) F-C-4R2111-4(20/80)	F-C-4R2110-3(18/54)
Platform Divider Part No. (For Taylor Wharton 10K)	P20-4R9951	P20-4R9953	P20-4R9955	P20-4R9957	P20-4R9959	P20-4R2111	P20-4R2110
24K	F-C-4R9951-5(120/600) F-C-4R9951-7(120/840)	F-C-4R9953-3(108/324) F-C-4R9953-4(108/432) F-C-4R9953-5(108/540)	F-C-4R9955-3(88/264) F-C-4R9955-4(88/352) F-C-4R9955-5(88/440)	F-C-4R9957-3(80/240) F-C-4R9957-4(80/320) F-C-4R9957-5(80/400)	F-C-4R9959-3(57/171) F-C-4R9959-4(57/228) F-C-4R9959-5(57/285)	F-C-4R2111-3(56/168) F-C-4R2111-4(56/224)	F-C-4R2110-3(52/156)
Platform Divider Part No. (For Taylor Wharton 24K)	P31-4R9951	P31-4R9953	P31-4R9955	P31-4R9957	P31-4R9959	P31-4R2111	P31-4R2110
38K	F-C-4R9951-5(210/1050) F-C-4R9951-7(210/1470)	F-C-4R9953-3(156/468) F-C-4R9953-4(156/624) F-C-4R9953-5(156/780)	F-C-4R9955-3(144/432) F-C-4R9955-4(144/578) F-C-4R9955-5(144/720)	F-C-4R9957-3(136/408) F-C-4R9957-4(136/544) F-C-4R9957-5(136/680)	F-C-4R9959-3(106/318) F-C-4R9959-4(106/424) F-C-4R9959-5(106/530)	F-C-4R2111-3(92/276) F-C-4R2111-4(92/368)	F-C-4R2110-3(81/243)
Platform Divider Part No. (For Taylor Wharton 38K)	P39-4R9951	P39-4R9953	P39-4R9955	P39-4R9957	P39-4R9959	P39-4R2111	P39-4R2110

Frame Part Number (total frames total canisters)	Bag Manufacturer						
	7120-2	7005-2 7303-2 7039-2	7400-2 7403-2 7410-2 7025-2	DF-200	DF-700	RCM-91D	791-05 791-05U 8-0346-0
Tank Model Number	C-7120	C-7005	C-7400	C-DF-200	C-DF-700	C-91D	CBBC-V1
3K	F-C-7120-4(36/144)	F-C-7005-2(18/36)	F-C-7400-2(18/36)	F-C-DF200-4(11/88)		F-C-91D-3(8/24)	
10K	F-C-7120-4(58/232) F-C-7120-5(58/290) F-C-7120-6(58/348)	F-C-7005-2(34/68) F-C-7005-3(34/102)	F-C-7400-2(34/68)	F-C-DF200-4(20/80) F-C-DF200-6(20/120)	F-C-DF700-4(16/64) F-C-DF700-6(16/96)	F-C-91D-3(30/90) F-C-91D-4(30/120) F-C-91D-5(30/150)	F-C-CBBC-V1-6(90/540) F-C-CBBC-V1-7(90/630) CF-9-3-T(14/882)
Platform Divider Part No. (For Taylor Wharton 10K)	P20-7120	P20-7005	P20-7400	P20-DF200	P20-DF700	P20-91D	NONE
24K	F-C-7120-4(152/608) F-C-7120-5(152/760) F-C-7120-6(152/912)	F-C-7005-2(96/192) F-C-7005-3(96/288)	F-C-7400-2(96/192)	F-C-DF200-4(56/224) F-C-DF200-6(56/336)	F-C-DF700-4(40/160) F-C-DF700-6(40/240)	F-C-91D-3(70/210) F-C-91D-4(70/280) F-C-91D-5(70/350)	F-C-CBBC-V1-6(216/1296) F-C-CBBC-V1-7(216/1512) CF-9-3-T(33/2079)
Platform Divider Part No. (For Taylor Wharton 24K)	P31-7120	P31-7005	P31-7400	P31-DF200	P31-DF700	P31-91D	NONE
38K	F-C-7120-4(256/1024) F-C-7120-5(256/1280) F-C-7120-6(256/1536)	F-C-7005-2(148/296) F-C-7005-3(148/444)	F-C-7400-2(148/296)	F-C-DF200-4(92/368) F-C-DF200-6(92/552)	F-C-DF700-4(68/272) F-C-DF700-6(68/408)	F-C-91D-3(136/408) F-C-91D-4(136/544) F-C-91D-5(136/680)	F-C-CBBC-V1-6(368/2208) F-C-CBBC-V1-7(368/2576) CF-9-3-T(53/3339)
Platform Divider Part No. (For Taylor Wharton 38K)	P39-7120	P39-7005	P39-7400	P39-DF200	P39-DF700	P39-91D	NONE

# Work Sheet for Customized Upright Freezer Racks

Design your own upright freezer rack using a copy of this work sheet. Fill in the spaces for h, l, w, n and m and FAX to your local distributor.

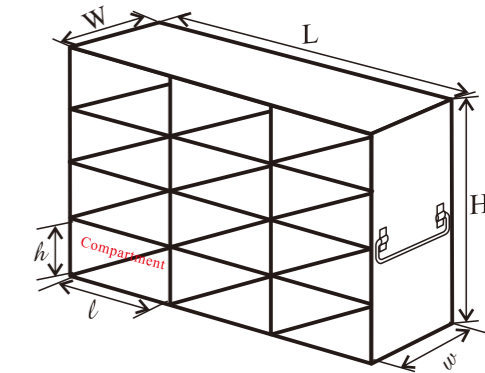

H, L, W: outside dimensions of rack  
 h, l, w: internal dimensions of compartment:  
 h: internal height for holding boxes  
 l: internal length for the rack holding boxes  
 w: internal width for the rack holding boxes  
 n: # of layers vertically  
 m: # of boxes horizontally

**Step1: Please specify parameters and number of racks in the following table:**  
 (Make sure the rack you require is upright freezer rack.)

Unit	h	l	w	Tolerance (Optional)			n	m	Security Locking Device	Number of Racks Needed
				$\Delta h$	$\Delta l$	$\Delta w$				
<input type="radio"/> Inch				$\pm$	$\pm$	$\pm$			<input type="radio"/> Yes	
<input type="radio"/> mm				$\pm$	$\pm$	$\pm$			<input type="radio"/> No	

If tolerance is not specified, default tolerance of  $\pm 0.5$ mm will be used for  $\Delta h$ ,  $\Delta l$ ,  $\Delta w$ .

If your storage boxes are listed in the table at bottom of this sheet, use the standard dimension for h, l and w in the table.

**Step2: Calculate H, L, W by using the following formulae:**

Unit used in following formulae is millimeter. Please convert unit into millimeter for h, l and w if "Inch" is used in above table.

$$H = (h \times n) + 0.5 \times (n-1) + 2.8 = \underline{\hspace{2cm}}$$

$$L = (l \times m) + 0.7 \times (m-1) + 2.8 = \underline{\hspace{2cm}}$$

$$W = w + 1.4 = \underline{\hspace{2cm}}$$

Optional:

$$\Delta H = \Delta h \times n = \underline{\hspace{2cm}}$$

$$\Delta L = \Delta l \times m = \underline{\hspace{2cm}}$$

$$\Delta W = \Delta w = \underline{\hspace{2cm}}$$

**Step3: Fax or submit the form**

Please provide contact name and number:

Contact name:

Dept. and Institution:

Tel:

Fax:

Email:

# Work Sheet for Customized Upright Freezer Drawer Racks

Design your own upright freezer drawer rack using a copy of this work sheet. Fill in the spaces for h, l, w, n and m and FAX to your local distributor.

- H, L, W: outside dimensions of rack
- h, l, w: internal dimensions of compartment:
  - h: internal height for holding boxes
  - l: internal length for the rack holding boxes
  - w: internal width for the rack holding boxes
- n: # of layers vertically
- m: # of boxes horizontally

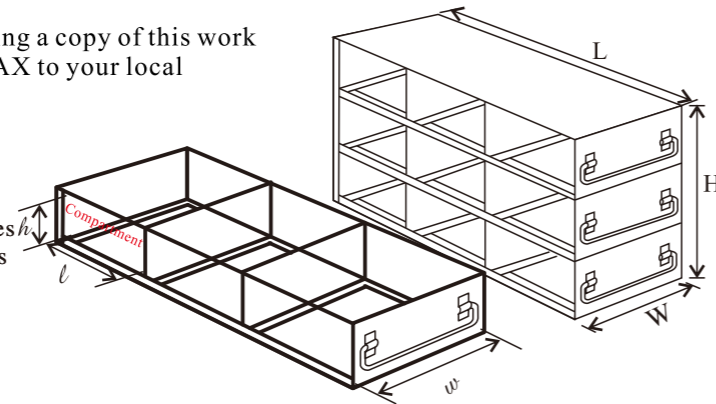

**Step1: Please specify parameters and number of racks in the following table:**  
(Make sure the rack you require is upright freezer drawer rack.)

Unit	h	l	w	Tolerance (Optional)			n	m	Security Locking Device	Number of Racks Needed
				$\Delta h$	$\Delta l$	$\Delta w$				
<input type="radio"/> Inch				$\pm$	$\pm$	$\pm$			<input type="radio"/> Yes	
<input type="radio"/> mm									<input type="radio"/> No	

If tolerance is not specified, default tolerance of  $\pm 0.5\text{mm}$  will be used for  $\Delta h$ ,  $\Delta l$ ,  $\Delta w$ .  
If your storage boxes are listed in the table at bottom of this sheet, use the standard dimension for h, l and w in the table.

**Step2: Calculate H, L, W by using the following formulae:**

Unit used in following formulae is millimeter. Please convert unit into millimeter for h, l and w if "Inch" is used in above table.

$$H = (h + 2.6) \times n + 0.6 \times (n+1) + 2 \times n + 1.2 = \underline{\hspace{2cm}}$$

$$L = (l \times m) + 0.6 \times (m+1) + 6 = \underline{\hspace{2cm}}$$

$$W = w + 6.7 = \underline{\hspace{2cm}}$$

Optional:

$$\Delta H = \Delta h \times n = \underline{\hspace{2cm}}$$

$$\Delta L = \Delta l \times m = \underline{\hspace{2cm}}$$

$$\Delta W = \Delta w = \underline{\hspace{2cm}}$$

**Step3: Fax or submit the form**

Please provide contact name and number:

Contact name: \_\_\_\_\_ Dept. and Institution: \_\_\_\_\_

Tel: \_\_\_\_\_ Fax: \_\_\_\_\_

Email: \_\_\_\_\_

# Work Sheet for Customized Vertical Racks

Design your own vertical freezer rack using a copy of this work sheet. Fill in the spaces for h, w, d, n and m and FAX to your local distributor. Remember to specify if you want stainless steel or aluminum.

- H, D, W: outside dimensions of rack
- h, d, w: internal dimensions of compartment:
  - h: internal height for holding boxes
  - d: internal width for holding boxes
  - w: internal depth for the rack holding boxes
- n: # of layers vertically
- m: # of boxes horizontally

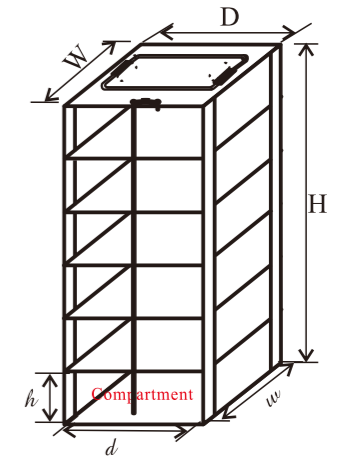

**Step1: Please specify parameters number of racks in the following table:**  
(Make sure the rack you require is vertical rack.)

Unit	h	d	w	Tolerance (Optional)			n	m	Security Locking Device	Number of Racks Needed
				$\Delta h$	$\Delta d$	$\Delta w$				
<input type="radio"/> Inch				$\pm$	$\pm$	$\pm$			<input type="radio"/> Yes	
<input type="radio"/> mm									<input type="radio"/> No	

If tolerance is not specified, default tolerance of  $\pm 0.5\text{mm}$  will be used for  $\Delta h$ ,  $\Delta d$ ,  $\Delta w$ .  
If your storage boxes are listed in the table at bottom of this sheet, use the standard dimension for h, d and w in the table.

**Step2: Calculate H, D, W by using the following formulae:**

Unit used in following formulae is millimeter. Please convert unit into millimeter for h, d and w if "Inch" is used in above table.

$$H = (h \times n) + 0.5 \times (n-1) + 1.4 = \underline{\hspace{2cm}}$$

$$D = d + 3.8 = \underline{\hspace{2cm}}$$

$$W = w + 7 = \underline{\hspace{2cm}}$$

Optional:

$$\Delta H = \Delta h \times n = \underline{\hspace{2cm}}$$

$$\Delta D = \Delta d = \underline{\hspace{2cm}}$$

$$\Delta W = \Delta w = \underline{\hspace{2cm}}$$

**Step3: Fax or submit the form**

Please provide contact name and number:

Contact name: \_\_\_\_\_ Dept. and Institution: \_\_\_\_\_

Tel: \_\_\_\_\_ Fax: \_\_\_\_\_

Email: \_\_\_\_\_