

# Simport<sup>®</sup>

*A Family Owned Company Since 1975*

**Contributing to the Evolution of  
Disposable Laboratory Plasticware  
for 40 Years**



[www.simport.com](http://www.simport.com)

*Available in Canada from...*

MJS  
**BioLynx**  
INC.

1-888-593-5969 • [www.biolynx.ca](http://www.biolynx.ca) • [tech@biolynx.ca](mailto:tech@biolynx.ca)





# New Products



**C566**  
Page 13



**B350ECO**  
Page 5



**M478**  
Page 44



**M513-2**  
Page 42



**M795-1**  
Page 45



**S700**  
Page 68



**M961**  
Page 55



**T323**  
Page 104

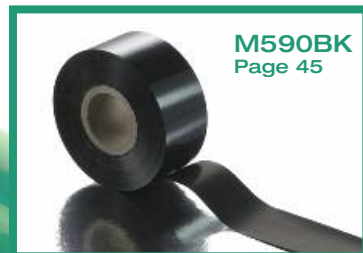

**M590BK**  
Page 45

and many more!

# TABLE OF CONTENTS

A	Analyzer Cups	10
B	Bags, Sterile	144-146
	Bar Coding Facilities	86
	Base Molds	42-43
	Beakers, Disposable	9
	Bioblock™ Deep Well Plates	80-85
	Biodisposer™	11
	Biopsy Bags	44
	Biopsy Foam Pads	44
	Biotube™ System	76-79
	Block Mailer	44
	Blood Dilution Vials	141
	Bottles, Urine	5-7
	Boxes, Storage	77, 95-97, 110, 136-137
C	Cabinets, Cassette	43
	Caps for Culture Tubes	131-132
	Capinsert™	98, 128
	Capsules, Tissue	45
	Cassettes, Tissue	22-42
	Cassette Cover, Metal	23
	Cassette Thermal Printing Foil	45
	Cassettes for printers	23, 34-41
	Cell Spreader	21
	Centrifuge Tubes	140
	Centrifuge Tubes (micro)	113-129
	Centrifuge Tube Racks	142-143
	Cliklock™ Microcentrifuge Tubes	113-115
	Closures for Culture Tubes	131-132
	Cluster Tubes	76-79
	Combi-Box™	110
	Combi-Rack™	110
	Contact Plate	20
	Containers, Collapsible	11
	Containers, Specimen	9-19, 54-59
	CoreDish®	56-58
	Cryogenic Vials	88-97, 122
	Cryostore™ Storage Boxes	94-95
	Cryovial® Tubes and Accessories	88-98
	Cups, Analyzer / Fibrin	10
	Cultubes™	133
	Culture Tubes	21, 122, 125
	Cytology Funnels	60-65
	CytoSep Cyto Funnels	60-65
D	Deep Well Plates	80-85
	Dishes, Petri	20
	DrainRack™	46-47
	Dishes, Weighing	8
	Dissecting Boards	48-49
	Dropette® Pipets	66-67
E	EasyDip™	50
	EcoTainer™	5
	Embedding Rings	45
	Embedding Cassettes	22-42
F	Fibrin Cups	10
	FitsAll™ Caps	132
	Foam Pads	44
	FlexTainer™ Containers	11
	Funnels	9
	Funnels, Cytology	60-65
H	Histosette® Cassettes	24-27
	HistoTainer™	54-55
	Hitachi Analyzer Cups	10
I	Ino-loop™ Inoculating Loops	21
J	Jars, Microscope Slides	52
L	LockMailer™	52
	Loops, Inoculating	21
	Low Surface Tension Microcentrifuge Tubes	106
M	Macrosette® Cassette	42
	Marker Pen	45
	Micrewtube®	116-129
	Microsette™ Cassettes	28
	Microcentrifuge Tubes	113-115
	Microcentrifuge Tube Rack	129
	Micromesh™	30
	Microscope Slide Folder	59
	Microscope Slide Mailer	52-53
	Microscope Slide Storage	45-47
	Microscope Slide Tray	45
	Microtubes	116-129
	Microtube Racks	129, 142
	MultiRack™	143

# TABLE OF CONTENTS

OneHand™ Rack	129	Specimen Containers, Formalin Prefilled	54-59
Paraffin Block Mailer	44	Snap Cap Containers	9, 19
PCRack™	110	SnapTwist® Scintillation Vials	141
PCR Tube Racks	110	SpecTainer™	12-15
PCR Sealing Mat	111	Spreader, Cell	21
PCR Reaction Plates	104-108	SputEm™ Collection Kit	10
PCR Reaction Strips	102-103	StainTray™	51
PCR Reaction Tubes	100-101	Stoppers for Culture Tubes	131-132
PCR Sealing Film & Foil	111	Storage Box for Microcentrifuge Tubes	115
PCR Storage Boxes	110	Storage Box for Microwtubes®	129
Petri Dishes	20	Storage Boxes for Cryovial® Tubes	95-97
Pierce-It™ Caps	132	Storage Cabinets	43
Pipets, Transfert	66-67	StoreBox™ Storage Boxes for Sample Tubes	136-137
Plates, Deep Well	80-85	Stylus, Diamond	45
Plates, PCR	104-108	Swabs	139
Printing Facilities	86	Swingsette™	32-33
QuickLoad™ Cassettes	23, 34-41	Tamper Evident	117-119
Racks for Centrifuge Tubes	142-143	Test Tube Racks	134-135
Racks for 1.1 ml Cluster Tubes	77-78	Thermal Conductive Racks	68-75
Racks for Cryovial® and Microwtube®	98, 142-143	Thermal Printing Foil	45
Racks for Microcentrifuge Tubes	142	Tissue Capsules	45
Racks for PCR Tubes	110, 142	Tissue Cassettes	22-42
Racks for Test Tubes	142-143	Titer Plates	80-85
Racks, Thermal Conductive	68-75	Transfer Pipets	66-67
Rings, Embedding	42	Tricorn™ Beakers	9
Roller for Sealing Plates	111	Tubes, Culture	130, 132-133
Rotor-Gene™ Q PCR Consumables	109	Tubes, Microcentrifuge	113-15
Sample Cups	10	Tubes, Sample	19, 134-135, 138-139
Sample Tubes	19, 134-135, 138-139	Tubes, Sterile	19, 77, 89-94, 122-123, 133
Sample Tube Storage Boxes	144-145	Twenty-four Hour Urine Collection Bottles	5-7
Sampling Bags	144-145	UniMailer™	53
Scintillation Vials	141	UniRack™	142
Screw Caps with Septum	127, 137	Uniset™	29
SecureSeal™ Sealing Film and Foil	85, 111	Urinalysis Specimen Collection Tube	130
SecurTainer™	16-18	Urine Bottles	5-7
Septum Screw Caps	119, 129	Urine Specimen Containers	5-7, 12-15
SeraNest™	10	Urine Collection Bottle	5-7
Sharps Containers	11	Urine Collection System / Tube	132
SlideFile™	46-47	Urisafe®	6
SlideFolder™	59	Uritainer™	7
SlideTray™	45	Vacucap™	131
Slimsette™	31, 36, 40	Vials	89-94, 141
SnapTwist® Microwtube®	119	Water Specimen Container	17
Specimen Collection Tube, Urinalysis	138	Weighing Dishes	8
Specimen Containers	9-19	WorkStation Rack for Cryovial® and Microwtube®	98
		Write-on™ Marker Pen	45

## Simport Catalog Number Index

Cat. #	Page(s)	Cat. #	Page(s)	Cat. #	Page(s)	Cat. #	Page(s)
B350	5-6	M505T	39	M976	58	T403	132
B352	9	M506	29	P200	66-67	T404	131
B360	7	M506T	39	S207	141	T405	133
B700	9	M507	30	S220	141	T406	133
B720	10	M507SL	35	S500	142	T407	132
B721	10	M507T	40	S501	142	T408	140
C200	10	M508	30	S510	143	T410	140
C300	11	M509	31	S600	143	T415	133
C566	12-14	M509SL	36	S610	143	T416	133
C567	12-15	M509T	40	S700	68-75	T417	21, 132
C570	11	M510	31	T100	77, 79	T420	140
C571	19	M510SL	36	T101	78	T425	133
C572	19	M510T	41	T105	78-79	T426	133
C575	16	M511	31	T110	78-85	T500	134
C576	17	M512	42	T301	90	T501	135
C577	18	M513	42	T307	139	T502	135
C580	19	M515	32	T308	92	T504	137
C581	19	M516	32	T309	89	T514	136-137
C590	11	M517	33	T310	93	T550	138
D210	20	M517SL	37	T311	91	T552	138-139
D250	8	M517T	41	T312	98	T553	138
D251	8	M518	33	T313	98	V130	141
D252	8	M518SL	37	T314	94-95		
F490	9	M518T	41	T315	98		
L200	21	M590	45	T319	109		
L300	21	M618	48	T320	107-103		
M460	45	M620	48	T321	102		
M470	45	M625	48	T322	103		
M471	45	M630	49	T323	107		
M474	42-43	M700-50	46	T324	108		
M475	42-43	M700-100	47	T325	100-101		
M476	44	M710-50	46	T327	110		
M477	44	M710-100	47	T328-96	110		
M478	44	M750-20	59	T329	85, 110		
M480	23	M755-20	59	T330	113-115		
M480SL	23	M800	53	T331	115		
M480T	23	M900	50	T332	122, 124		
M481	23	M905	50	T334	122, 124		
M482	34	M906	50	T335	122, 124		
M483	34	M918	51	T336	123, 124		
M485	27	M919	51	T338	123, 124		
M485SL	34	M920	51	T339	123, 124		
M486	27	M921	51	T340	128		
M486SL	34	M950	52	T340TP	117-119		
M490	24	M958	54	T341	118		
M491	24	M959	55	T341TP	109-111		
M492	26	M960	54	T342	120		
M492T	38	M961	55	T343	120		
M493	26	M963	63	T345	128		
M493T	38	M964	61	T347	127		
M495	43-45	M965	62-63	T350	129		
M498	25	M966	65	T360	129		
M499	25	M967	64	T361	127		
M502	28	M968	65	T400	130		
M503	28	M970	56-58	T401	131		
M505	29	M975	58	T402	123		



## INTRODUCING THE NEXT GENERATION OF 24-HR URINE COLLECTION CONTAINERS



### The EcoTainer 24™



*Biodegradable is now available for the laboratory. Make it your choice and protect your environment.*

### B350ECO

#### 24-Hr Urine collection container

The Simport® EcoTainer 24™ will biodegrade to become some of the soil's organic components in less than 7 years, instead of up to 400 years when using conventional plastics.

The Simport® URISAFE®, one of the most innovative 24-HR Urine Containers on the market today, is now available in a new version: The EcoTainer 24™, a rapidly degradable URISAFE® Container. Plastics take hundreds of years to degrade naturally in the environment. The Simport® EcoTainer 24™ will biodegrade to become some of the soil's organic components in less than 7 years in constant contact with the soil instead of up to 400 years when using conventional plastics. The only condition that is necessary for the EcoTainer 24™ to biodegrade is constant contact with other degrading material. No heat, physical stress, oxygen or sunlight necessary. The EcoTainer 24™ has the ability to break down safely and quickly, by biological means, into the raw materials of nature and disappear into the environment.

- Does not contain heavy metals
- No negative effect to its physical properties
- No heat, light or mechanical stress needed for product breakdown
- No toxic residue
- Fully degradable within 7 years, aerobically or anaerobically

#### Image of high-density polyethylene surface after 12 months soil burial

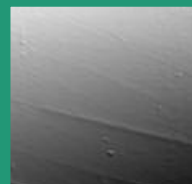

Non biodegradable surface

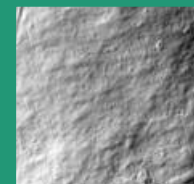

Surface of the EcoTainer 24™

#### Uniquely designed to be the most user friendly



- 1 The unique snap valve pour spout is easily popped open and offers dripless pouring
- 2 Specially designed leakproof screw cap with liner for safer transport
- 3 Large centrally located handle for good balance and ease of manipulation
- 4 Place container in upright position and sample volume can be read in 100 ml increments

#### The unique snap valve pour spout:

- Controlled flow rate for better handling of poured volumes
- Reduced risks of aerosol contamination when pouring
- Eliminates splashing and exposure to hazardous body fluids

#### Low form design:

- Convenient refrigerator storage with less wasted space
- Anatomically designed for ease of patient use
- Large 79 mm screw lid

#### Chemical and physical resistance

- Can be subjected to freezing, thawing and EtO gas sterilization without causing changes in materials or physical appearance
- Metal free and resistant to hydrochloric acid
- Can be gamma sterilized

Cat. #	Vol. (Liters)	Dimensions (cm)	Qty/Cs
B350ECO	3	11.5 x 24.5 x 16.0 H	40

For IVD use CE

## URISAFE®

### 24-HR URINE COLLECTION CONTAINER

Container made of high-density polyethylene  
Cap made of polypropylene

Uniquely designed to be  
the most user friendly

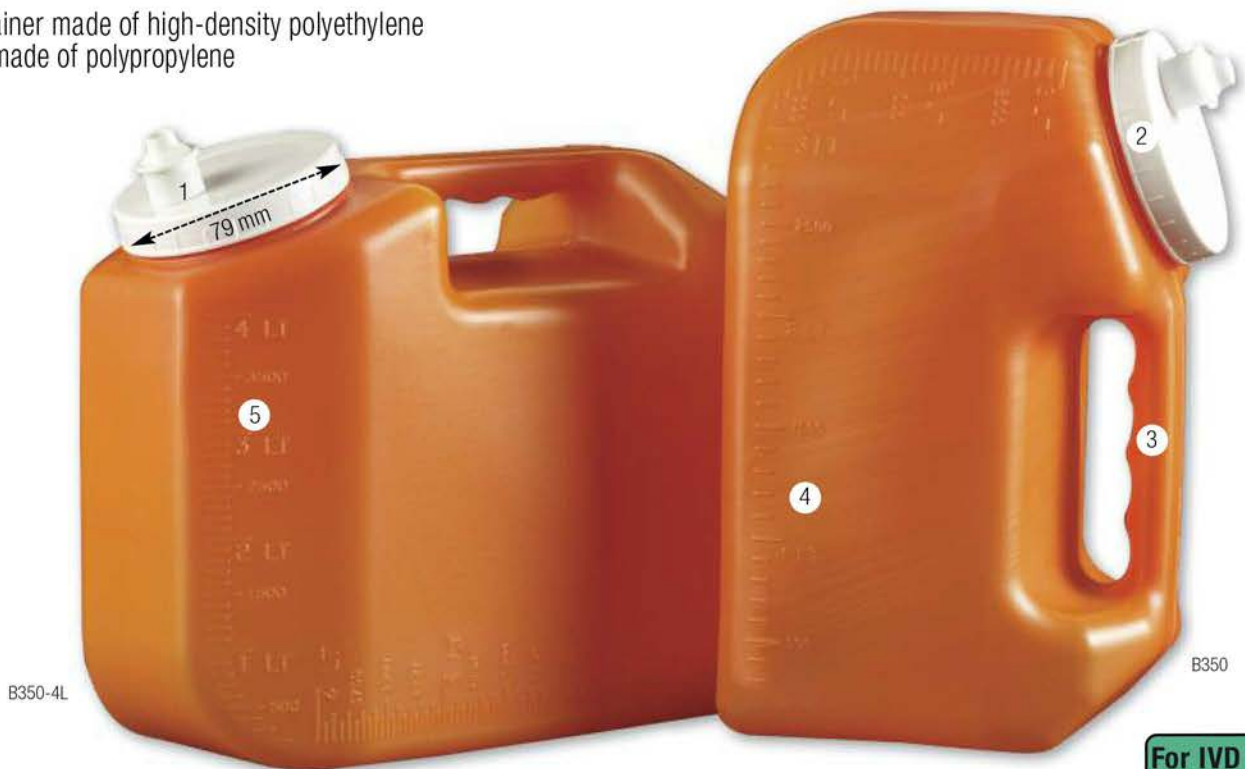

For IVD use



On the 4 liter model, urine can be poured into a tube by simply tilting the container forward without having to lift it.

- 1 The unique snap valve pour spout is easily popped open and offers dripless pouring
- 2 Specially designed leakproof screw cap with liner for safer transport
- 3 Large centrally located handle for good balance and ease of manipulation
- 4 Metal free and resistant to hydrochloric acid
- 5 Sample volumes can be read in 100 ml increments

#### The innovative cap:

- Snap valve pouring spout incorporated
- Leakproof: a cap liner ensures safe sample transport

#### The unique snap valve pour spout:

- Easily popped open or pushed shut
- Offers dripless pouring
- Controlled flow rate for better handling of poured volumes
- Reduced risks of aerosol contamination when pouring
- Eliminates splashing and exposure to hazardous body fluids

#### Low form design:

- Convenient refrigerator storage with less wasted space
- Anatomically designed for ease of patient use

#### Large central handle:

- Can be gripped comfortably with three fingers
- Permits pouring off of samples with ease and reduces fatigue

#### Chemically resistant:

- Metal, latex, zinc and fluorescence free
- Resistant to hydrochloric acid.
- Can be subjected to freezing, thawing and EtO gas sterilisation without causing changes in materials or physical appearance

#### Graduated vertically and horizontally:

- Graduations are easy to read
- Place container upright and read in 100 ml increments
- Can be gamma sterilized

The URISAFE® Urine Collection Containers are USER FRIENDLY to both patients and laboratory personnel. Two sizes are available: 3 and 4 liters.

Cat. #	Vol. (Liters)	Dimensions (cm)	Qty/Cs
B350	3	11.5 x 24.5 x 16.0 H	40
B350-4L	4	11.5 x 24.5 x 20.1 H	30



### B350-4HCL Urisafe with HCl Preservative

This model offers the convenience of being pre-filled with 30 ml 6N HCl. All patient instructions are clearly detailed on label.

Each container is individually wrapped.

Cat. #	Vol. (Liters)	Dimensions (cm)	Qty/Cs
B350-4HCL	4	11.5 x 24.5 x 20.1 H	30



# URITAINER™

## 24-HR URINE COLLECTION CONTAINER

Container made of high-density polyethylene  
Cap made of polypropylene



This model is also available as a biodegradable version. Please contact Simport® for details.

For IVD use



On all models, the unique snap valve pour spout is easily popped open and offers dripless pouring.

- 1 The unique snap valve pour spout is easily popped open and offers dripless pouring
- 2 Specially designed leakproof screw cap with liner for safer transport
- 3 Metal free and resistant to hydrochloric acid
- 4 Large handle can be gripped comfortably
- 5 Volume level read in 50 ml increments
- 6 Can be gamma sterilized

This more conventional style urine bottle is available in 2 sizes: 2.5 L and 3.5 L. However, it incorporates some of the great features of the URISAFE 24-Hr Urine Collection Container.

Cat. #	Vol. (Liters)	Dimensions (cm)	Qty/Cs
B360-25	2.5	13.3 x 13.3 x 23.2 H	40
B360-35	3.5	13.3 x 13.3 x 29.5 H	24



Large handle can be gripped comfortably

The innovative cap:

- Snap valve pouring spout incorporated
- Leakproof: a cap liner ensures safe sample transport

The unique snap valve pour spout:

- Easily popped open or pushed shut
- Offers dripless pouring
- Controlled flow rate for better handling of poured volumes
- Reduced risks of aerosol contamination when pouring
- Eliminates splashing and exposure to hazardous body fluids

Large central handle:

- Can be gripped comfortably
- Permits pouring off of samples with ease and reduces fatigue

Chemically resistant:

- Metal and latex free
- Zinc and fluorescence free
- Resistant to hydrochloric acid
- Can be subjected to freezing, thawing and EtO gas sterilisation without causing changes in materials or physical appearance

### Labels for URISAFE® & URITAINER™ Containers

Three optional labels are offered

- Patient identification label
- Patient instruction label
- Caution label

Cat. #	Description	Qty/Roll	QtyPk
B350-4	Patient identification label	100	1000
B350-5	Patient instruction label	100	1000
B350-6	Caution label	100	1000

**PATIENT AND TEST INFORMATION FOR 24-HOUR URINE COLLECTION**

Patient Name: \_\_\_\_\_  
 Pt. # \_\_\_\_\_  
 Test Request: \_\_\_\_\_  
 Prescribe Address: \_\_\_\_\_  
 Int'l Office Used: \_\_\_\_\_  
 Total Volume Collected: \_\_\_\_\_  
 Collector Starting Time: Hour \_\_\_\_\_ Day \_\_\_\_\_  
 Collector Ending Time: Hour \_\_\_\_\_ Day \_\_\_\_\_

B350-4

**Patient Instructions for Collecting a 24-Hour Urine Specimen**  
 Important: To insure accurate test results, please follow these instructions carefully.

**A)** Ask your laboratory whether or not you should refrigerate this bottle during the collection period.  
**B)** At the hour you choose to start the collection period, urinate into a toilet and flush as usual.  
**C)** Record the starting time and date in the space provided below.  
**D)** For the next 24 hours, collect all your urine in this bottle.  
**E)** Be sure to urinate just when the 24 hour collection period ends and include this urine in the bottle.  
**F)** Record the ending time and date in the space provided below.  
**G)** Promptly bring the bottle back to the laboratory.

Collection Starting Time: Hour \_\_\_\_\_ Date \_\_\_\_\_  
 Collection Ending Time: Hour \_\_\_\_\_ Date \_\_\_\_\_

B350-5



B350-6



## D250

### Antistatic Weighing Dishes

Made of antistatic polystyrene

Simport® Weighing Dishes will resist diluted acids, aqueous solutions, alcohols and bases. They are ideal for many applications such as weighing, dispensing or storing. They are safe, contaminant-free, biologically inert economical containers for weighing liquid or powdered samples in the laboratory. Flat bottom ensures perfect stability on countertops. They have a smooth surface providing accurate pour-outs with minimal sample loss and facilitating weighing of static-affected samples. Simport® dishes can also be used as quick freeze trays for sample material, discard trays for broken ampoules, or mixing trays for small batches. Will withstand temperatures up to 80 °C.

Cat.#	Volume (ml)	Color	Dimensions (mm)	Qty/Pk	Qty/Cs
D250-1	10	White	40 x 40 x 8 H	500	4000
D250-2	100	White	78 x 78 x 25 H	250	500
D250-3	300	White	127 x 127 x 25 H	250	500



## D251

### Antistatic Pour Boats

Made of antistatic polystyrene

These 3 sizes of pour boats are specially made to facilitate dispensing of powdered and liquid materials. Smooth, uniform and economical, the molded material used is thicker than conventional weighing dishes. Can be used safely to weigh static-affected materials. Will withstand temperatures up to 80 °C.

Cat.#	Volume (ml)	Dimensions (mm)	Qty/Pk	Qty/Cs
D251-1	12	50 x 37 x 8 H	250	2000
D251-2	140	128 x 76 x 25 H	250	250
D251-3	270	180 x 117 x 25 H	250	250



## D252

### Antistatic Hexagonal Weighing Dishes

Made of antistatic polystyrene

Excellent for handling solids or liquids during weighing. Easily bent into pouring spouts, the dishes enable non-spill transfer. Molded hexagonal design provides greater balance protection and safety. Will not react with most substances. Suitable for weighing of static-affected samples. The dishes are stackable for easy storage. Will withstand temperatures up to 80 °C.

Cat.#	Volume (ml)	Top I.D. (mm)	Base I.D. (mm)	Height (mm)	Qty/Pk	Qty/Cs
D252-1	9	35	25	10	500	4000
D252-2	58	70	47	20	250	500
D252-3	203	115	85	22	250	500
D252-4	355	130	95	30	250	500

## B352

### Specimen Bottle

Made of polypropylene

Features a dip-stick well for small volume testing and a pour spout for dripless pouring. Its square base makes it very stable. Can be autoclaved. Also useful as a drosophila stock bottle.

Graduated from 0 to 170 ml and from 0 to 6 oz.

Snap cap supplied separately (see B352-1).

Cat. #	Vol. (ml)	Size (mm)	Neck dia.	Qty/Cs
B352	170	55 x 55 x 102 H	34 mm	500

## B352-1

### Snap Cap for B352 Specimen Bottle

Made of polyethylene

Cat. #	Size Dia.	Qty/Cs
B352-1	46 mm	2000



## B700

### TRICORN™ Beakers

Made of polypropylene

Tricorn™ beakers provide three dripless pouring spouts. Tough, unbreakable and suitable for use with commonly used acids, alkalis and solvents. Autoclavable.

Cat. #	Vol. (ml)	Graduations (ml)	Size (mm)	Qty/Cs
B700-50	50	5	49 x 57 H	100
B700-100	100	10	58 x 72 H	100
B700-250	250	10	76 x 90 H	100
B700-400	400	20	85 x 108 H	100
B700-800	800	50	107 x 133 H	100
B700-1L	1000	50	115 x 145 H	100



A sturdy translucent reusable beaker that can be autoclaved, yet inexpensive enough to be disposable.



Dripless pouring spout offers more security.



If they fall, they will not break like glass beakers do.



## F490

### Disposable Funnels

Made of either polystyrene or polypropylene

Both sizes are tapered at a 60° angle with inside fluting.

Cat. #	Material	Top I.D. (mm)	Height (mm)	Stem Length (mm)	Stem Opening (mm)	For use with Paper dia.	Qty/Cs
F490-1	Polystyrene	57	69	27	5.3	11 cm	100
F490-2	Polystyrene	64	76	27	5.0	12.5 cm	100
F490-3	Polypropylene	56	69	27	5.1	11 cm	100
F490-4	Polypropylene	63	75	27	5.0	12.5 cm	100

## B720-13 & 16

### SeraNest™ Sample Cups

Made of polystyrene

These sample cups will hold perfectly on top of blood collection tubes. Just pour the blood sample into a SeraNest™ and its low shoulder will hold securely on the tube. No need to relabel. Two sizes available.

## B720-8

### Analyzer Cups for Hitachi Systems

Made of polystyrene

## B720-40 Fibrin Cups

Made of polyethylene

Precision molded for constant volume and uniform heat transfer.



Cat. #	Dia.	Volume	Qty/Bag	Qty/Cs
B720-8	12.7 mm	2 ml	1000	10,000
B720-13	13.9 mm	1 ml	1000	5000
B720-16	16.7 mm	2 ml	1000	5000
B720-40	11.5 mm	1.3 ml	1000	10,000



## B721-1 Roche Cobas Sample Tube 2.5 ml

Made of polystyrene

This tube is used with the Roche Cobas Analyzer. It has perfect clarity for easy viewing of contents. This graduated false bottom tube has a capacity of 2.5 ml and will accept bar code labels.

For caps, see series T404-3 on page 131.



Cat. #	Volume	Qty/Pk	Qty/Cs
B721-1	2.5 ml	1000	2000

## C200G

### SputEm™ Sputum Collection System

Made of polypropylene

The ideal way to collect, carry and process biological samples. The unit features a base which already incorporates a removable sterile 50 ml graduated polypropylene conical tube that can withstand centrifugation up to 5000 RPM, or 3000g.

Available in a light green color, three narrow vertical windows allow the contents of the tube to be discreetly seen. A wide base ensures great stability and prevents tipping of the unit. The large collection funnel is made in such a way that specimens fall directly into the graduated centrifuge tube and do not contaminate the outside threads. The centrifuge tube screw cap is being kept sterile at all times under the snap cap on top of the funnel.

A patient label is already affixed on top of the unit and can easily be transferred to the tube before leaving for the laboratory. The base can be used as a support during transit. Each unit is sterile and individually wrapped.



For IVD use

Cat. #	Color	Qty/Cs
C200G	Green	72

BEFORE COLLECTION



- Remove from package.
- Fill in patient label.
- Lift the hinged lid.
- Avoid touching inside of funnel.
- Close lid after each use.

AFTER COLLECTION



- Remove snap cap to expose sputum tube threaded cap.
- Remove funnel top and invert over tube.
- Squeeze middle part of Sputum Collection System and screw tube into threaded cap.
- Discard funnel top.
- Remove patient label.
- Place patient label on side of tube.
- Place tube back in its base and send to lab.



## C300 BIODISPOSER™ Portable Disposal Containers

Made of polypropylene

This polypropylene container and cover can be flash autoclaved without melting. Available in two colors: red and yellow. Dimensions: 8.89 cm x 8.89 cm x 15.24 cm H (3 x 3 x 6 in. H) Volume: 1 L.

Cat. #	Color	Qty/Cs
C300-1R	Red	50
C300-1Y	Yellow	50



## C570-12 Non Sterile Disposable Specimen Container

Polypropylene Container - Polyethylene Screw Cap

Graduated. Heavy-duty thick wall construction of both container and lid ensures a positive leakproof seal time after time. The drip ring on the container reduces the chances of contamination.

Wide base design for stable reliable use. Molded-in graduations up to 128 ml / 4 oz. Supplied non sterile and packaged in bags of 100 stacked by 10's. Yellow caps packed separately in bags of 100.

Cat. #	Packaging	Qty/Cs
C570-12	Bag / 100	500



## C590 FlexTainer™ Containers

Made of polyethylene

This is a great space-saving expandable accordion-type jug which flattens down for easy transport. Great for carrying and storing numerous types of fluids, it is suitable for any laboratory. The FlexTainer™ folds away for easy storage. Made of high strength polyethylene, it features a comfortable carry grip and screw-on cap with on/off spout. It is available in many sizes up to 8 liters. Each bottle is individually wrapped.



Spigot can be adjusted for more accurate handling of flow rate.



Spigot is easy to open and close with one finger.



Cat. #	Volume	Qty/Pk	Qty/Cs
C590-3L	3 Liters	12	48
C590-5L	5 Liters	12	48
C590-8L	8 Liters	12	36



# The SpecTainer™ and SecureTainer™ Family

*If you TRULY care about your sample, let us help you PROTECT its integrity!*



The SpecTainer™ and SecureTainer™ Family offers one of the most innovative and effective specimen containers on the market today. If you have ever purchased Urine and Specimen Containers in the past, you know that the packaging leaves much to be desired. The content that goes in, especially liquid samples, is very prone to leakage around the lid. This can lead to spills and messes in your trays, lab counters and all transportation systems used. A better screw cap had to be designed.

Simport® has discovered a solution to this problem and we are proud to announce the arrival of our SpecTainer™ and SecureTainer™ series. We offer you the most diverse choice of secure and reliable containers from 20 to 120 ml, including a unique ECO-friendly model biodegrading within 7 years instead of 4 centuries. Urine containers are also available in a sterile and non sterile version. And let's not forget our two unique versions of tamper evident designs ensuring your peace of mind during transport and storage.



For IVD use



## INTRODUCING THE ECO-FRIENDLY SPECTAINER™, THE NEXT GENERATION OF URINE COLLECTION CONTAINERS



### C566 & C567

### Eco-Friendly SpecTainer™ Urine Container



Container made of polypropylene / Closure made of polyethylene

The Simport® Eco-Friendly SpecTainer™, one of the most innovative specimen containers on the market today, is now available in a new version: The Eco-Friendly SpecTainer™, a rapidly degradable Specimen Container. Plastics take hundreds of years to degrade naturally in the environment. The only condition that is necessary for the Eco-Friendly SpecTainer™ to biodegrade is constant contact with other degrading material. No heat, physical stress, oxygen or sunlight necessary. The Eco-Friendly SpecTainer™ has the ability to break down safely and quickly, by biological means, into the raw materials of nature and disappear into the environment.



The Simport® EcoTainer 24™ will biodegrade to become some of the soil's organic components in less than 7 years in constant contact with the soil instead of up to 400 years when using conventional plastics.

- Does not contain heavy metals
- No negative effect to its physical properties
- No heat, light or mechanical stress needed for product breakdown
- No toxic residue
- Fully degradable within 7 years, aerobically or anaerobically

### Image of high-density surface after 12 months soil burial

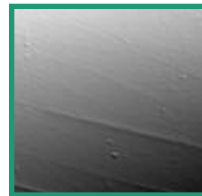

Non biodegradable surface

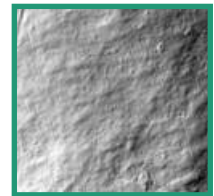

Surface of the Eco-Friendly SpecTainer™



For color coding purposes, use a Capinsert™ on top of the closure. Ten different colors are available. (see T345 Series).

For more details and colors available please refer to page 18.

Name/Nom/Nombre: \_\_\_\_\_  
 Date/Fecha: \_\_\_\_\_ Time/Hora/Hora: \_\_\_\_\_  
 Specimen/Especimen: \_\_\_\_\_  
[www.simport.com](http://www.simport.com)

Label has space for patient identification



Cat. #	Vol. (ml)	Type	Cap Color	Closure	Qty/Pk	Qty/Cs
C566-60DOECO	60	Non Sterile	Gold	Tamper Evident	100	500
C566-90DOECO	90	Non Sterile	Gold	Tamper Evident	100	400
C566-120DOECO	120	Non Sterile	Gold	Tamper Evident	100	300
C566-60AQSECO	60	Sterile	Aqua	Tamper Evident	100	500
C566-90AQSECO	90	Sterile	Aqua	Tamper Evident	100	400
C566-120AQSECO	120	Sterile	Aqua	Tamper Evident	100	300

Cat. #	Vol. (ml)	Type	Cap Color	Closure	Qty/Pk	Qty/Cs
C567-60DOECO	60	Non Sterile	Gold	Conventional	100	500
C567-90DOECO	90	Non Sterile	Gold	Conventional	100	400
C567-120DOECO	120	Non Sterile	Gold	Conventional	100	300
C567-60AQSECO	60	Sterile	Aqua	Conventional	100	500
C567-90AQSECO	90	Sterile	Aqua	Conventional	100	400
C567-120AQSECO	120	Sterile	Aqua	Conventional	100	300

For IVD use CE



If you **TRULY** care about your sample,  
let us help you **PROTECT** its integrity!



## C566

### The TAMPER EVIDENT SpecTainer™ I Urine Container



Container made of polypropylene / Closure made of polyethylene

For applications needing the utmost security where sample integrity is of high importance. A great feature of the SpecTainer™ I is that it incorporates a unique tamper evident screw cap ensuring peace of mind during transport or storage situations where someone might have tampered with the specimen. For color coding purposes, place a Capinsert™ on top of closure (see Series T345). Ten different colors are available.

Both containers and caps are manufactured without the use of plasticisers or mold release agents. All material used is free from latex. Containers are 95kpa compliant. Available in three sizes: 60, 90 and 120 ml. The 60 ml size however is not graduated. The sterile container protects its sterility with a tamper evident seal.

### Anatomy of the SpecTainer™ I

1. Insertion of a Capinsert™ allows color coded identification of contents
2. Molded ridges around lid make it easy to open and close
3. Tamper evident sealing ring for better sample protection
4. Specially designed notches to ensure a perfect tamper evident seal
5. Warning label has space for patient identification
6. Ridges around base offer a better grip during opening and closing



Screw cap on until a clicking noise is heard. This is when the plastic ring is firmly seated and locked over the container threads. When removing the tamper evident screw cap for the first time, the perforation is severed, thereby ensuring easy recognition that the container has been opened.



Cat. #	Vol. (ml)	Type	Cap Color	Closure	Qty/Pk	Qty/Cs
C566-60Y	60	Non Sterile	Yellow	Tamper Evident	100	500
C566-90Y	90	Non Sterile	Yellow	Tamper Evident	100	400
C566-120Y	120	Non Sterile	Yellow	Tamper Evident	100	300
C566-60CYS	60	Sterile	Cyan	Tamper Evident	100	500
C566-90CYS	90	Sterile	Cyan	Tamper Evident	100	400
C566-120CYS	120	Sterile	Cyan	Tamper Evident	100	300



*With Conventional Closure*



## C567 The SpecTainer™ II Urine Container



Container made of polypropylene / Closure made of polyethylene

This model uses a conventional leakproof screw cap. It is designed for collection, transport and storage of specimens, the polypropylene containers are safe to use even in adverse conditions. Containers are uniquely stackable, shatter resistant and are manufactured from virgin high-clarity polypropylene. They are designed with a straight side format. Available in three sizes: 60, 90 and 120 ml. The 60 ml size however is not graduated.

### Anatomy of the SpecTainer™ II

1. Insertion of a Capinsert™ allows color coded identification of contents
2. Molded ridges around lid make it easy to open and close
3. Leakproof screw cap with a unique integrated leak-resistant seal
4. Warning label has space for patient identification
5. Ridges around base offer a better grip during opening and closing



Containers are easily and safely stackable.



Tamper evident labels are placed on all sterile containers. Sterility is assured if unbroken.



For color coding purposes, use a Capinsert™ on top of the closure. Ten different colors are available. (see T345 Series). For more details and colors available please refer to page 18.

For IVD use

Cat. #	Vol. (ml)	Type	Cap Color	Closure	Qty/Pk	Qty/Cs
C567-60Y	60	Non Sterile	Yellow	Conventional	100	500
C567-90Y	90	Non Sterile	Yellow	Conventional	100	400
C567-120Y	120	Non Sterile	Yellow	Conventional	100	300
C567-60CYS	60	Sterile	Cyan	Conventional	100	500
C567-90CYS	90	Sterile	Cyan	Conventional	100	400
C567-120CYS	120	Sterile	Cyan	Conventional	100	300

If you **TRULY** care about your sample,  
let us help you **PROTECT** its integrity!



## C575 SecurTainer™ I TAMPER EVIDENT Specimen Containers



Container made of polypropylene  
Closure made of polyethylene

Especially designed for collection, transport and storage of specimens, Simport® offers shatter resistant polypropylene containers, eliminating most problems of leakage and evaporation. Containers are uniquely stackable, shatter resistant and are manufactured from virgin, polypropylene. The magenta lids are ribbed for easy opening when hands are wet or gloved while the jars are stackable for easy, safe storage and almost transparent to allow specimens to be viewed without opening. These straight sided containers are manufactured from virgin polypropylene with a unique integrated leak-resistant seal.

The uniqueness of the SecurTainer™ I is that it incorporates a unique tamper evident screw cap ensuring your peace of mind during transport or storage situations where someone might have manipulated the specimen without your prior knowledge. Can also be used without using the tamper evident locking mechanism.

Both containers and caps are manufactured without the use of plasticisers or mold release agents. Material used in manufacturing is free from latex. All containers are 95kpa compliant. Available in many sizes from 20 to 120 ml. Non sterile. Containers and caps packaged separately in bags of 100. Functional temperature range: -90 °C to +100 °C.

Cat. #	Volume	Qty/Pk	Qty/Cs
C575-20MA	20 ml	100	500
C575-40MA	40 ml	100	500
C575-60MA	60 ml	100	500
C575-90MA	90 ml	100	400
C575-120MA	120 ml	100	300

For IVD use



For color coding purposes, use a Capinsert™ on top of the closure. Ten different colors are available. (see T345 Series).  
For more details and colors available please refer to page 18.



Place sample in container.



Push up tab on side of vial.



Screw on Tamper evident cap completely.



When opening the vial, the tamper evident ring will detach itself from the cap.



The SecurTainer™ I can also be used without the tamper evident feature.

If you **TRULY** care about your sample,  
let us help you **PROTECT** its integrity!

## C576 SecurTainer™ II TAMPER EVIDENT Specimen Containers



This model uses a different tamper evident concept when compared to the C575 Series. No locking tab is necessary when the tamper evident feature is used. Simply screw the cap on the container and the tamper evident sealing ring is automatically locked in place. When unscrewed, the ring is detached from the cap, showing clearly that the container was opened.

Also designed for collection, transport and storage of specimens, the polypropylene containers are safe to use even in adverse conditions. Containers are uniquely stackable, shatter resistant and are manufactured from virgin, polypropylene. These straight sided containers are available in many sizes from 20 to 120 ml. Non sterile. Containers and caps packaged separately in bags of 100.



Screw cap on until a clicking noise is heard. This is when the plastic ring is firmly seated and locked over the container threads. When removing the tamper evident screw cap for the first time, the perforation is severed, thereby ensuring easy recognition that the container has been opened.

For IVD use

Cat. #	Volume	Qty/Pk	Qty/Cs
C576-20MA	20 ml	100	500
C576-40MA	40 ml	100	500
C576-60MA	60 ml	100	500
C576-90MA	90 ml	100	400
C576-120MA	120 ml	100	300



For color coding purposes, use a Capinsert™ on top of the closure. Ten different colors are available. (see T345 Series). For more details and colors available please refer to page 18.



## C575-120MATI HydroTainer™ TAMPER EVIDENT Water Sample Container



Container made of polypropylene / Closure made of polyethylene

This 120 ml sterile container is ideal for collecting water samples from a multitude of sources prior to laboratory testing. It contains one 10 mg sodium thiosulfate tablet for reducing and dehalogenating the sample.

The uniqueness of the HydroTainer™ is that it incorporates a tamper evident screw cap ensuring peace of mind during transport or storage situations where someone might have manipulated the specimen. Supplied with I.D. label and tamper evident seal.

Cat. #	Volume	Qty/Pk	Qty/Cs
C575-120MATI	120 ml	100	300



## C577

### SecurTainer™ III Specimen Containers

Container made of polypropylene / Closure made of polyethylene



Chemically resistant and shatterproof, The SecurTainer™ III Specimen Containers are supplied with a leakproof screw cap, particularly important when transporting hazardous material. Ideal for transport and storage of urine, sputum and most liquids or particulate samples.

Containers are uniquely stackable, shatter resistant and are manufactured from virgin, high-clarity polypropylene. Available in many sizes from 20 to 120 ml. Containers and caps packaged separately in bags of 100. Non sterile. Functional temperature range: -90 °C to +100 °C.

### Anatomy of a SecurTainer™ III

1. Ridges around base offer a better grip during opening and closing.
2. Insertion of a Capinsert™ allows color coded identification of contents.
3. Molded ridges around lid make it easy to open and close.



Cat. #	Volume	Qty/Pk	Qty/Cs
C577-20W	20 ml	100	500
C577-40W	40 ml	100	500
C577-60W	60 ml	100	500
C577-90W	90 ml	100	400
C577-120W	120 ml	100	300

## T345

### Color Coding CAPINSERT™



Made of polypropylene

The Capinsert™ is used to color code a multitude of Simport® products according to your specific needs. It is inserted on top of the closure and has a write-on frosted area for sample identification.

Cat. #	Color	Cat. #	Color	Qty/Bag
T345B	Blue	T345P	Pink	500
T345GY	Gray	T345R	Red	500
T345G	Green	T345V	Violet	500
T345L	Lilac	T345W	White	500
T345O	Orange	T345Y	Yellow	500
		T345AS	Assorted*	500

\* Blue, lilac, red, yellow and white



## C571 & C572 30 and 50 ml Sample Tubes

**95kPa  
TESTED**

Tube made of polypropylene / Cap made of polyethylene

Conical bottom tubes with self-standing base graduated from 10 to 30 ml and 10 to 50 ml respectively in 5 ml increments. Chemically resistant and shatterproof, they are supplied with a leakproof screw cap, particularly important when transporting hazardous material. Ideal for transport and storage of urine, sputum and most liquids or particulate samples. Molded-in graduations make them easy to read. Available sterile or non sterile. The caps for Series C572 accept T345 Capinserts (see page 18 for details and colors). Functional temperature range: -90°C to +121°C.

30 ml tube dimensions: 25.3 mm dia x 111 mm length.  
50 ml tube dimensions: 30 mm dia x 115 mm length.



C571-1	Sterile	50	Green	25	500
C571-2	Non sterile	50	Yellow	100	500
C572-1	Sterile	30	White	25	500
C572-2	Non sterile	30	White	100	500

**For IVD use**



For color coding purposes, use a Capinsert™ on top of the closure. Ten different colors are available. (see T345 Series). For more details and colors available please refer to page 18.

## C580 Specimen Containers with Snap Cap

Cap and closure are made of polypropylene

These disposable containers made of polypropylene, are ideal for collection and storage of fluids, powders, solids, pathology specimens and hazardous samples. Lids are tight fitting.

Cat. #	(ml/oz)	Opening (mm)	Height (mm)	Qty/Cs
C580-3	300/10	111	45	100
C580-4	500/17	111	75	100
C580-5	1000/34	111	140	100



The 2600 and 5700 ml sizes are provided with a plastic handle to facilitate handling

## C581 Tamper Evident Specimen Containers

Cap and closure are made of polypropylene

These disposable containers are ideal for collection, transport and storage of fluids, powders, solids, pathology specimens and hazardous samples. Tight-fitting lids prevent leaks and odors. They incorporate a tamperproof lid which is opened by first removing tab on side of lid, then by lifting the cover. They resist temperatures up to 121 °C. The two larger sizes are supplied with a plastic handle for easy carrying.

Cat. #	(ml/oz)	Opening (mm)	Height (mm)	Qty/Cs
C581-300	300/10	111	45	100
C581-500	500/17	111	75	100
C581-1L	1000/34	111	140	100
C581-2600	2600/87	200	124	25
C581-5700	5700/140	225	195	10

## D210

### Sterile Petri Dishes

Made of polystyrene

Simport® Petri dishes are available in a variety of shapes and sizes for use in routine procedures and with automated equipment. Economical, optically clear dishes are precision-molded from biomedical grade polystyrene so cultures are clearly visible without distortion. Dishes are packaged in heavy-wall polyethylene sleeves. **Not for tissue culture application.**

Cat. #	Model (mm)	Actual Dim. (mm)	Vol. (ml)	Qty/Sleeve	Qty/Cs
D210-7	100 x 20	90 x 20	100	20	500
D210-7WL	100 x 20	90 x 20	100	20	500
D210-8	100 x 25	90 x 25	125	20	500
D210-8R	100 x 25	90 x 25	125	20	500
D210-13	60 x 15	55 x 13	28	20	500
D210-14	50 x 9	50 x 9	12	20	500
D210-15	35 x 10	35 x 10	9	20	500

#### D210-7 Commonly referred to as a 100 mm x 20 mm dish

For unimpaired observation of specimen growth with raised straight ridge around top for stable stacking

#### D210-7WL Commonly referred to as a 100 mm x 20 mm dish

This dish has three venting ribs into the underside of the lid to prevent condensation build-up

#### D210-8 Commonly referred to as a 100 mm x 25 mm dish

Accommodates deeper fills for longer culture periods. Used for fungal cultures, plant propagation. This dish has three venting ribs into the underside of the lid to prevent condensation build-up.



#### D210-8R Commonly referred to as a 100 mm x 25 mm dish

Similar to D210-8 but with non-vented lid having a raised straight ridge around top for stable stacking

#### D210-13 Commonly referred to as a 60 mm x 15 mm dish

For use whenever a small quantity of culture is desirable. For unimpaired observation of specimen growth with raised straight ridge around top for stable stacking. This dish has three venting ribs on the edge of the dish to prevent condensation build-up.

#### D210-14 Commonly referred to as a 50 mm x 9 mm dish

Box type dish, for classroom studies, water studies, culturing of mycobacteria, aerosol testing, membrane filter and immunodiffusion techniques. Tight lid prevents sample dehydration.

#### D210-15 Commonly referred to as a 35 mm x 10 mm dish

Selected for small quantities of culture media. For unimpaired observation of specimen growth with raised straight ridge around top for stable stacking. This dish has three venting ribs into the underside of the lid to prevent condensation build-up.

## D210-16 Square Petri Dish with Grid

Made of polystyrene

#### Commonly referred to as a 100 mm x 15 mm dish

Free from optical distortion and sterile. These dishes are ideal for phage typing, susceptibility testing, plate counts, and probe assays. Each 13 mm grid is marked numerically in one direction and alphabetically in the other. This dish has four venting ribs into the underside of the lid to prevent condensation build-up.

Cat. #	Model (mm)	Actual Dim. (mm)	Vol. (ml)	Qty/Sleeve	Qty/Cs
D210-16	100 x 15	90 x 15	110	10	500



## D210-17 Contact Plate

Made of polystyrene

These dishes are free from optical distortion and are sterile. The grid is 10 x 10 mm with numbered and lettered squares to facilitate counting and to locate colonies. The D210-17D model is designed with a convex bottom in order to save on culture medium.

Cat. #	Actual Dim. (mm)	Vol. (ml)	Qty/Sleeve	Qty/Cs
D210-17	60 x 15	20	20	500
D210-17D	60 x 15	15	20	500



## D210-18 Absorbent Pad Petri Dishes

Made of polystyrene

These 50 x 9 mm sterile petri dishes with absorbent pads are ideal for culturing micro-organisms on either agar or broth based media. Designed to accommodate 47 mm diameter membrane filters. These dishes are stackable and have squared off edges on both the top and bottom which provide convenient grips for one handed opening. The snug fitting top ensures that neither the absorbent pad nor the agar media will dry out during incubation. A frosted area on top of lid permits labeling.

Cat. #	Actual Dim. (mm)	Style	Qty/Sleeve	Qty/Cs
D210-18A	50 x 9	Without Pads	20	500
D210-18B	50 x 9	With Pads	20	500

## L200 INO-LOOP™ Inoculating Loops and Needles

Made of high impact polystyrene

Loops and needles are smooth and flexible to facilitate uniform streaking without damaging the gel surface. Needles are straight and suitable for removal of specimens of single colonies. Packed sterile in safe, tamperproof, zip-lock resealable bags.

Disposable inoculating loops and needles do not require flaming and thus eliminate the risk of infection due to aerosol formation of pathogenic substances.

Cross contamination due to improper sterilization is eliminated. They can be used under hoods without danger, and are color-coded for ease of size identification. Certificate of conformity available upon request. Total length: 227 mm

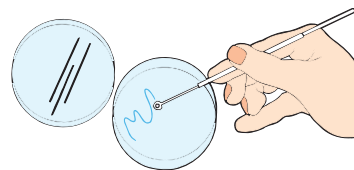

Smooth loop surface provides uniform and gentle streaking.

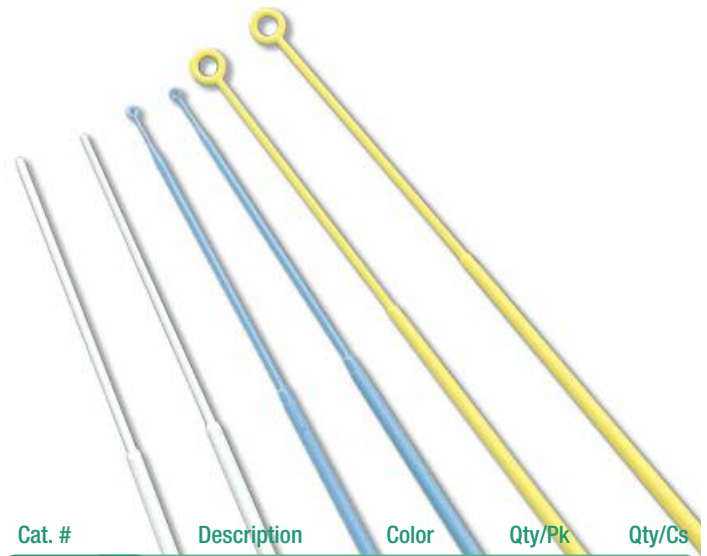

Cat. #	Description	Color	Qty/Pk	Qty/Cs
L200-1	Loop 1µl	Blue	25	1000
L200-1A	Loop 1µl	Blue	10	1000
L200-11	Loop 1µl	Blue	1	250
L200-2	Loop 10µl	Yellow	25	1000
L200-2A	Loop 10µl	Yellow	10	1000
L200-21	Loop 10µl	Yellow	1	250
L200-3	Needle	White	25	1000
L200-3A	Needle	White	10	1000
L200-31	Needle	White	1	250

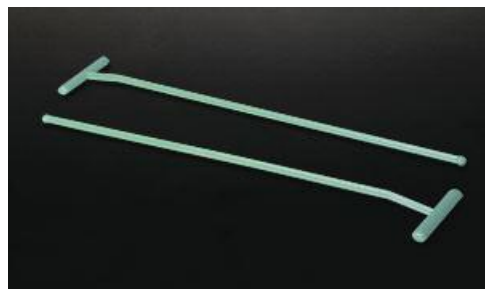

## L300 Bacterial Cell Spreader

Made of high impact polystyrene

No flame sterilization needed. Designed for easy spreading of cells onto the surface of an agar plate. Supplied sterile in individual packs. Total length of handle: 176 mm. Width of spreader: 36 mm

Cat. #	Sterile	Color	Qty/Pk	Qty/Cs
L300	Yes	Green	1	100



## T417 Culture Tubes 13 x 100 mm with Screw Cap

95kPa TESTED

Tube made of polystyrene / Cap made of polyethylene

These 8 ml screw cap tubes are available either sterile or non sterile. A special tamper evident cap is offered for applications needing the utmost security where sample integrity is of high importance. Tubes are made of optically clear polystyrene and can be centrifuged up to 3000 x g. These are not treated for cell culture. The sterile ones are sterilized by gamma radiation and are non pyrogenic.



Cat. #	Sterile	Tamper Evident	Qty/Bag	Qty/Cs
T417-4	No	No	Bulk	1000
T417-4S	Yes	No	125	1000
T417-4TP	No	Yes	Bulk	1000

# Histology Collection

## ACCEPT NO IMITATION

Thanks to years of experience in precision plastic molding, Simport® offers you the widest choice of Histology Disposables on the market. By choosing Simport®, you will be sure to find a cassette especially suited to fill your specific needs when processing regular tissue samples, single and multiple biopsies and also large specimens. Most models can be used with automated labeling machines. Simport® also manufactures many products to assist you with transportation, storage and staining of microscope slides.

Here is a brief list of available products:

- Biopsy Foam Pads
- Cassettes for Printers
- Cytology Funnels
- Disposable Base Molds
- Dissecting Boards
- Drain Racks
- Embedding Rings
- Microscope Slide Folder
- Microscope Slide Mailer
- Microscope Slide Staining Systems
- Microscope Slide Storage Boxes
- Microscope Slide Tray
- Modular Storage Drawers
- Prefilled Specimen Containers
- Tissue Capsules
- Tissue Cassettes with Metal Lid
- Tissue/Biopsy Cassettes with Plastic Lid



## M480 Embedding Cassettes

Made of acetal

Disposable plastic tissue cassettes are suitable for holding and identifying tissue samples in processing, embedding, and sectioning procedures. The cassettes fit securely in microtome chuck adapters. Cassette is totally resistant to the chemical action of histological solvents. These cassettes are designed to accept standard metal lids (cat.# M481) and will keep specimens in complete safety during processing. The slanted writing surface accepts markings easily, permitting sample identification throughout all stages of embedding and long afterwards when in archives. They are available in 11 colors. Each case contains 3 dispenser boxes of 500 cassettes.

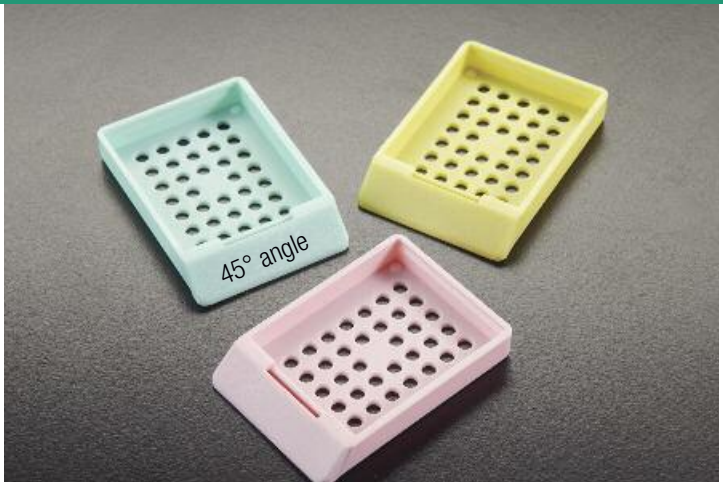

Cat. #	Color	Qty/Cs	Cat. #	Color	Qty/Cs
M480-2	White	1500	M480-8	Tan	1500
M480-3	Pink	1500	M480-9	Gray	1500
M480-4	Green	1500	M480-10	Lilac	1500
M480-5	Yellow	1500	M480-11	Orange	1500
M480-6	Blue	1500	M480-12	Aqua	1500
M480-7	Peach	1500			

Cat. #	Description	Qty/pk
M481	Metal Process Cover	25

## M481 Metal Lid for M480 Cassette

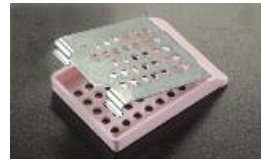

For IVD use



M480SL  
For ThermoFisher  
Printers

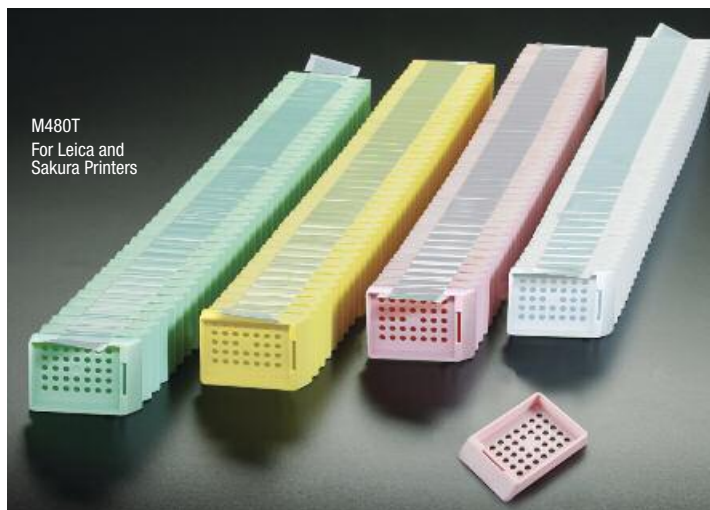

M480T  
For Leica and  
Sakura Printers

## M480SL & M480T Cassettes in QuickLoad™ Sleeves and Stacks

Made of acetal

The sleeved cassettes are especially made to be used with ThermoFisher printers. Cassettes with tape are to be used with Leica and Sakura Ink Jet printers. Molded from a special high density acetal polymer, they keep specimens safely submerged and are totally resistant to the chemical action of most solvents used in histology laboratories. The efficient flow-through slots maximize fluid exchange and ensure proper reagent drainage.

In Sleeves		In Stacks		
Cat. #	Qty/Cs	Cat. #	Qty/Cs	Color
M480-2SL	750	M480-2T	2000	White
M480-3SL	750	M480-3T	2000	Pink
M480-4SL	750	M480-4T	2000	Green
M480-5SL	750	M480-5T	2000	Yellow
M480-6SL	750	M480-6T	2000	Blue
M480-7SL	750	M480-7T	2000	Peach
M480-8SL	750	M480-8T	2000	Tan
M480-9SL	750	M480-9T	2000	Gray
M480-10SL	750	M480-10T	2000	Lilac
M480-11SL	750	M480-11T	2000	Orange
M480-12SL	750	M480-12T	2000	Aqua

Fluo Pink, Fluo Green and Fluo Yellow are also available. Minimum quantities apply. Contact us for more details.



Compatible with all  
cassette printers

For IVD use



## M490 HISTOSETTE® I Tissue Processing / Embedding Cassettes

Made of acetal

Disposable plastic cassettes hold tissue specimens during the embedding process, as well as in a storage file. Molded from a special high density polymer, these cassettes keep specimens safely submerged in liquid and are totally resistant to the chemical action of histological solvents. **The efficient flow-through slots maximize fluid exchange and ensure proper drainage.** The one-piece integral lid eliminates the need for separate steel lids. Just snap apart and conveniently lock the lid into the base of the cassette. They can be opened or closed as often as necessary and they always relock securely without danger of specimen loss. Anterior writing area at a 30° angle. Not suitable for automated printers.

Each case contains 3 dispenser boxes of 500 cassettes.

For IVD use



## M491 HISTOSETTE® I Biopsy Processing / Embedding Cassettes

Made of acetal

Disposable plastic cassettes similar to Series M490 but specially designed to hold biopsy specimens during the embedding process, as well as in a storage file. Anterior writing area at a 30° angle. Not suitable for automated printers.

Each case contains 3 dispenser boxes of 500 cassettes.

For IVD use

Tissue Cat. #	Biopsy Cat. #	Color	Qty/Cs
M490-2	M491-2	White	1500
M490-3	M491-3	Pink	1500
M490-4	M491-4	Green	1500
M490-5	M491-5	Yellow	1500
M490-6	M491-6	Blue	1500
M490-7	M491-7	Peach	1500
M490-8	M491-8	Tan	1500
M490-9	M491-9	Gray	1500
M490-10	M491-10	Lilac	1500
M490-11	M491-11	Orange	1500
M490-12	M491-12	Aqua	1500

Fluo Pink, Fluo Green and Fluo Yellow are also available. Minimum quantities apply. Contact us for more details.

### Anatomy of a Histosette® I

The snap off lid can be easily removed, slid forward and snapped into the locked position.

Because it has efficient flow-through slots, fluid exchange and proper drainage are maximized.

Larger unobstructed writing surface sloped at 30° angle.

Because it has a back mounted locking device, it will never open during processing.

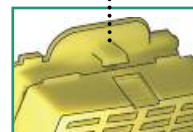

## M498 & M499 HISTOSETTE® I

Tissue & Biopsy Processing /  
Embedding Cassettes



Made of acetal

These cassettes are identical to Series M490 but the anterior writing area has a 45° instead of a 30° angle. The more acute angle makes these cassettes more suitable to be used with some models of cassette labeling instruments.

These disposable plastic cassettes hold tissue specimens very efficiently during the embedding process, as well as in a storage file. Molded from a special high density polymer, these cassettes keep specimens safely submerged in liquid and are totally resistant to the chemical action of histological solvents. **The efficient flow-through slots maximize fluid exchange and ensure proper drainage.** The one-piece integral lid eliminates the need for separate steel lids. Just snap apart and conveniently lock the lid into the base of the cassette. They can be opened or closed as often as necessary and they always relock securely without danger of specimen loss. Each case contains 3 dispenser boxes of 500 cassettes.

For IVD use

## M499 HISTOSETTE® I Biopsy Processing / Embedding Cassettes

Made of acetal

This model of cassette is similar to Series M498 and is specially designed to hold biopsy specimens during the embedding process.

Each case contains 3 dispenser boxes of 500 cassettes.

For IVD use

Tissue Cat. #	Biopsy Cat. #	Color	Qty/Cs
M498-2	M499-2	White	1500
M498-3	M499-3	Pink	1500
M498-4	M499-4	Green	1500
M498-5	M499-5	Yellow	1500
M498-6	M499-6	Blue	1500
M498-7	M499-7	Peach	1500
M498-8	M499-8	Tan	1500
M498-9	M499-9	Gray	1500
M498-10	M499-10	Lilac	1500
M498-11	M499-11	Orange	1500
M498-12	M499-12	Aqua	1500

Fluo Pink, Fluo Green and Fluo Yellow are also available. Minimum quantities apply. Contact us for more details.

## How to use a Histosette® I

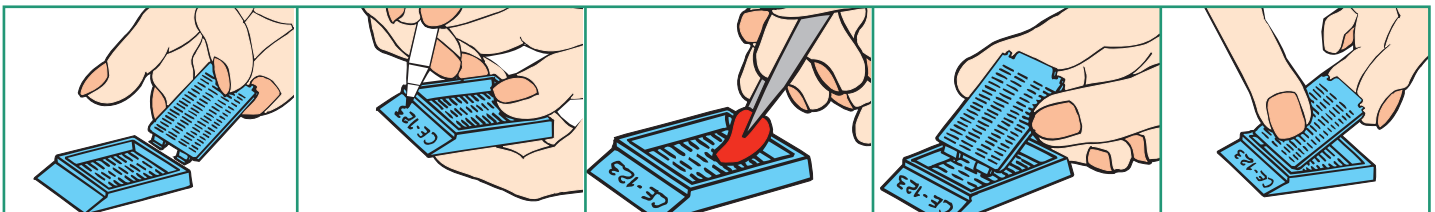

Separate cover by folding it forward and backward.

Identify in front or sides.

Insert sample.

Slide cover in place and lock it.

After processing, remove cover by pulling on back tab.



## M492 HISTOSETTE® II Tissue Processing / Embedding Cassettes

Made of acetal

Disposable plastic cassettes hold tissue specimens during processing and embedding, as well as in storage. Molded from a special high-density polymer, these patented cassettes keep specimens safely submerged in liquid and are totally resistant to the chemical action of histological solvents. **The efficient flow-through slots maximize fluid exchange and ensure proper drainage.** The one-piece integral lid eliminates the need for separate steel lids. They can be opened and closed as often as necessary and will always relock securely without danger of specimen loss.

The anterior writing area is slanted at a 45° angle to make the cassette more suitable to be used with certain types of cassette labeling instruments. Available in 11 colors. Each case contains 3 dispenser boxes of 500 cassettes.

For IVD use

Tissue Cat. #	Biopsy Cat. #	Color	Qty/Cs
M492-2	M493-2	White	1500
M492-3	M493-3	Pink	1500
M492-4	M493-4	Green	1500
M492-5	M493-5	Yellow	1500
M492-6	M493-6	Blue	1500
M492-7	M493-7	Peach	1500
M492-8	M493-8	Tan	1500
M492-9	M493-9	Gray	1500
M492-10	M493-10	Lilac	1500
M492-11	M493-11	Orange	1500
M492-12	M493-12	Aqua	1500



Compatible with most cassette printers

Fluo Pink, Fluo Green and Fluo Yellow are also available. Minimum quantities apply. Contact us for more details.

## M493 HISTOSETTE® II Biopsy Processing / Embedding Cassettes

Made of acetal

Similar to M492 but specially designed to hold biopsy specimens during the embedding process, as well as in a storage cabinet. Anterior writing area is at a 45° angle to make the cassette more suitable to be used with certain types of cassette labeling instruments. Each case contains 3 dispenser boxes of 500 cassettes.

For IVD use

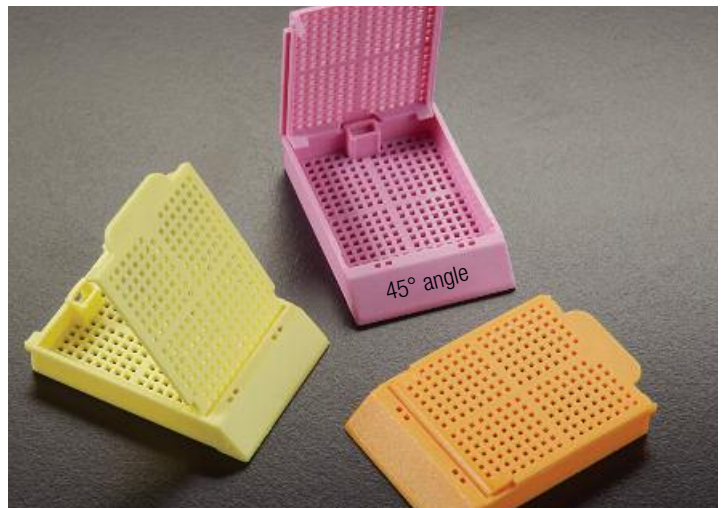

### Anatomy of a Histosette® II

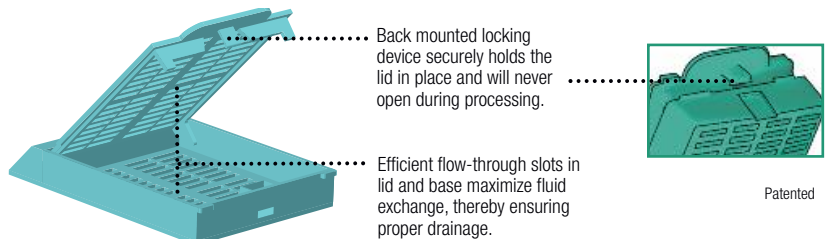
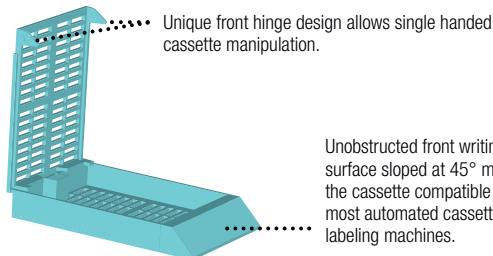

## M485 HISTOSETTE® II Tissue Processing / Embedding Cassettes

Made of acetal

Most convenient for cassette labeling instruments since covers are already removed from cassettes and are packaged separately in the case. Disposable plastic cassettes hold tissue specimens during processing and embedding, as well as in storage. Molded from a special high-density polymer, these patented cassettes keep specimens safely submerged in liquid and are totally resistant to the chemical action of histological solvents. **The efficient flow-through slots maximize fluid exchange and ensure proper drainage.**

The anterior writing area is slanted at a 45° angle to make the cassette more suitable to be used with certain types of cassette labeling instruments. Available in 11 colors. Each case contains 2 dispenser boxes of 500 cassettes and 1 dispenser box of 1000 covers.

For IVD use



Tissue Cat. #	Biopsy Cat. #	Color	Qty/Cs
M485-2	M486-2	White	1000
M485-3	M486-3	Pink	1000
M485-4	M486-4	Green	1000
M485-5	M486-5	Yellow	1000
M485-6	M486-6	Blue	1000
M485-7	M486-7	Peach	1000
M485-8	M486-8	Tan	1000
M485-9	M486-9	Gray	1000
M485-10	M486-10	Lilac	1000
M485-11	M486-11	Orange	1000
M485-12	M486-12	Aqua	1000

Fluo Pink, Fluo Green and Fluo Yellow are also available. Minimum quantities apply. Contact us for more details.



## M486 HISTOSETTE® II Biopsy Processing / Embedding Cassettes

Made of acetal

Most convenient for cassette labeling instruments but specially designed to hold biopsy specimens during the embedding process, as well as in a storage file. The covers are already removed from cassettes and are packaged separately in the case.

Anterior writing area is at a 45° angle to make the cassette more suitable to be used with certain types of cassette labeling instruments. Each case contains 2 dispenser boxes of 500 cassettes and 1 dispenser box of 1000 covers.

For IVD use

Cassettes and lids packaged separately



Compatible with all cassette printers

### How to use a Histosette® II

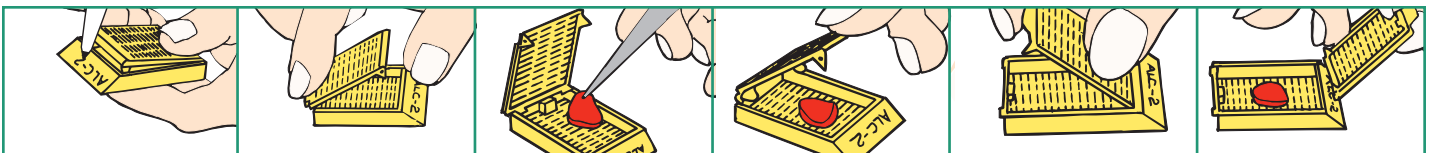

Identify sample on either the front labeling area.

Press on back tab to open cover.

Insert sample.

Close cover and press front of lid to lock it in place.

To open, lift tab at the back of cassette with forefinger while depressing the center of lid with thumb.

To remove the cover, pivot the lid forward and it will disconnect automatically.



## M502 MICROSETTE™ I Biopsy Processing / Embedding Cassettes

Made of acetal

Biopsy pads are no longer necessary with these innovative disposable plastic biopsy cassettes with a large compartment measuring 25 x 30 mm. Perfect even with needle biopsies since mesh holes have a diameter of only 0.26 mm while still allowing for maximum fluid exchange and drainage. Molded from a special high density polymer, these patented cassettes keep specimens safely submerged in liquid and are resistant to most histological solvents. They can be opened and closed as often as necessary and they always relock securely without danger of specimen loss. Available in 11 colors. Anterior writing area is at a 45° angle to make the cassette more suitable, to be used with certain types of cassette labeling instruments.

Each case contains four dispenser boxes of 250 cassettes with covers assembled.

For IVD use



Compatible with most cassette printers

### Anatomy of a Microsette™ I

Cover and base have over 2000, 0.26 mm square openings to maximize fluid exchange and ensure proper drainage.

Excellent fluid exchange through slots.

Back mounted locking device securely holds the lid in place and will never open during processing.

No biopsy pads necessary.

Air vents allowing more efficient filling with paraffin.

Biopsy Cassette with one compartment	Biopsy Cassette with six compartments	Color	Qty/Pk	Qty/Cs
M502-2	M503-2	White	250	1000
M502-3	M503-3	Pink	250	1000
M502-4	M503-4	Green	250	1000
M502-5	M503-5	Yellow	250	1000
M502-6	M503-6	Blue	250	1000
M502-7	M503-7	Peach	250	1000
M502-8	M503-8	Tan	250	1000
M502-9	M503-9	Gray	250	1000
M502-10	M503-10	Lilac	250	1000
M502-11	M503-11	Orange	250	1000
M502-12	M503-12	Aqua	250	1000

Fluo Pink, Fluo Green and Fluo Yellow are also available. Minimum quantities apply. Contact us for more details.

## M503 MICROSETTE™ I Biopsy Processing / Embedding Cassettes

Made of acetal

This model can hold up to six tissue specimens, each one placed in its own 7 x 12 mm (1/4 x 7/16 in.) compartment, numbered from 1 to 6.

No biopsy pads necessary. Cover and base have over 2000 square openings to maximize fluid exchange and ensure proper drainage. Approximately 170 holes (each having a diameter of 0.26 mm) per compartment.

Each case contains four dispenser boxes of 250 cassettes with covers assembled.

For IVD use



## M505 & M506 UNISLETTE™

Biopsy & Tissue Processing /  
Embedding Cassettes

Made of acetal

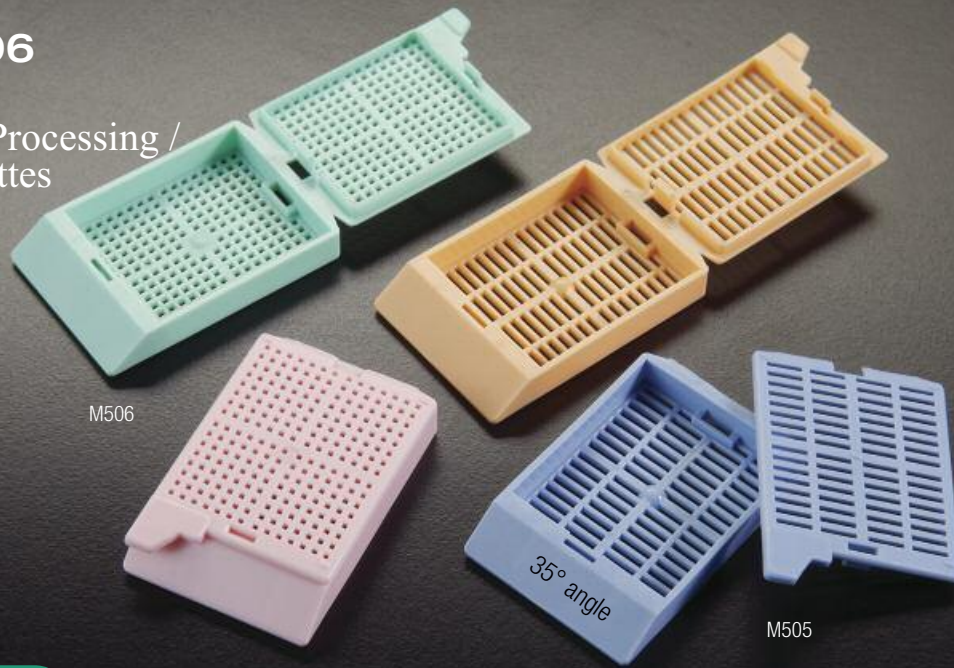

A great alternative to  
the Sakura Uni-Cassette®

Molded from a special high density polymer, these cassettes keep specimens safely submerged in liquid and are resistant to the chemical action of most histological solvents. The efficient flow-through slots maximize fluid exchange and ensure proper drainage. The one-piece integral lid eliminates the need for separate steel lids. The snap-latch and hinge-lock design of the UNISLETTE™ prevent early separation of base and lid and allow for one-hand operation. Lids can be opened and closed as often as necessary and they always relock securely without danger of specimen loss. Anterior writing area is at a 35° angle.

M506 Series is similar to M505 but specially designed to hold biopsy specimens during the embedding process.

Available in 11 colors. Each case contains 3 dispenser boxes of 500 cassettes.

For IVD use

Tissue Cat. #	Biopsy Cat. #	Color	Qty/Cs
M505-2	M506-2	White	1500
M505-3	M506-3	Pink	1500
M505-4	M506-4	Green	1500
M505-5	M506-5	Yellow	1500
M505-6	M506-6	Blue	1500
M505-7	M506-7	Peach	1500
M505-8	M506-8	Tan	1500
M505-9	M506-9	Gray	1500
M505-10	M506-10	Lilac	1500
M505-11	M506-11	Orange	1500
M505-12	M506-12	Aqua	1500

Have you ever considered  
The SLIMSETTE™ ?  
See M509 on page 31.



Fluo Pink, Fluo Green and Fluo Yellow are also available. Minimum quantities apply. Contact us for more details.



Compatible with Leica and Sakura cassette printers

### How to use a UNISLETTE™

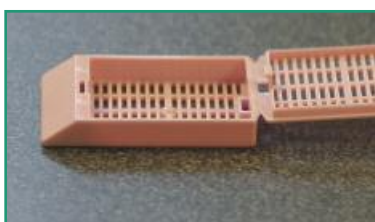

The cover of the Unislette is attached to the back of the base in an open position.



To close, simply tilt cover forward, holding it by the front tab.

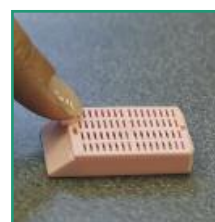

Push cover down until a click is heard.

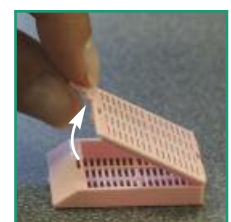

To open, tilt cover backward. It will remain attached to the base and can be closed again.



## M507 MICROMESH™ Biopsy Processing / Embedding Cassettes

**NO BIOPSY PADS REQUIRED**

Made of acetal

This version of the Micromesh™ offers 1676 square openings (0.38 mm) allowing for a greatly improved fluid exchange and drainage without having to use biopsy pads. Large anterior slots in both cassette and cover ensure that the Micromesh™ biopsy cassette will sink rapidly. A large square compartment measuring 27 mm is perfect even for needle biopsies. The cover does not protrude above the cassette, a great space saving feature allowing more cassettes to be stacked in automatic labeling machines and tissue processors.

Molded from a special high density polymer, these patented cassettes keep specimens safely submerged in liquid and are totally resistant to the chemical action of histological solvents. They can be opened and closed as often as necessary and they always relock securely without danger of specimen loss. Anterior writing area is at a 45° angle to make the cassette more suitable to be used with automated cassette printers. Available in 11 colors.

Each case contains four dispenser boxes of 250 cassettes with covers assembled.

For IVD use

Biopsy Cassette with one compartment	Biopsy Cassette with four compartments	Color	Qty/Cs
Cat. #	Cat. #		
M507-2	M508-2	White	1000
M507-3	M508-3	Pink	1000
M507-4	M508-4	Green	1000
M507-5	M508-5	Yellow	1000
M507-6	M508-6	Blue	1000
M507-7	M508-7	Peach	1000
M507-8	M508-8	Tan	1000
M507-9	M508-9	Gray	1000
M507-10	M508-10	Lilac	1000
M507-11	M508-11	Orange	1000
M507-12	M508-12	Aqua	1000

Fluo Pink, Fluo Green and Fluo Yellow are also available. Minimum quantities apply. Contact us for more details.

## Anatomy of Micromesh™ Cassettes

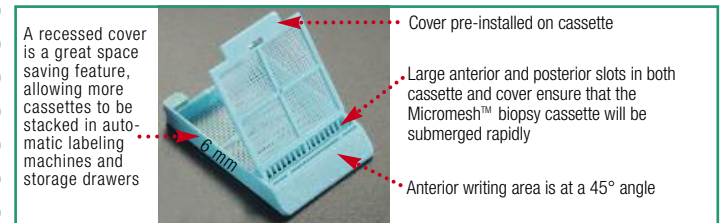

## M508 MICROMESH™ Biopsy Processing / Embedding Cassettes

Made of acetal

This model is similar to Series M507 but cassettes have four square compartments each measuring 13 mm. Cover and base have about 1676 square openings maximizing fluid exchange and ensuring proper drainage.

Each case contains four dispenser boxes of 250 cassettes with covers assembled.

For IVD use



Compatible with all cassette printers





## M509 SLIMSETTE™ Tissue Processing / Embedding Cassettes

Made of acetal

The SLIMSETTE™, a new generation emerging in the Simport® Histology Family. More compact, easier to use and more efficient than ever. Similar to the design of the M507 model, it incorporates a unique recessed cover, a great space saving feature allowing more cassettes to be stacked in automatic labeling machines and in storage cabinets.

Molded from a special high density polymer, these cassettes keep specimens safely submerged in liquid and are resistant to the chemical action of histological solvents. The SLIMSETTE™ ensures efficient fluid exchange and drainage thanks to 114 openings each measuring 1 x 5 mm. They can be opened and closed as often as necessary and they always relock securely without danger of specimen loss. Large labeling areas for easy identification. The anterior writing area is slanted at a 45° angle. Available in 11 colors.

Each case contains 3 dispenser boxes of 500 cassettes with covers assembled. Dimensions: 41 x 28.5 x 6 mm H (1<sup>5</sup>/<sub>8</sub> x 1<sup>1</sup>/<sub>8</sub> x 1/4 in. H)



For IVD use

Compatible with all cassette printers



## M510 SLIMSETTE™ Biopsy Processing / Embedding Cassettes

Made of acetal

Similar to M509 but specially designed to hold biopsy specimens during the embedding process, as well as in a storage cabinet. Anterior writing area is at a 45° angle to make the cassette more suitable to be used with certain types of cassette labeling instruments. This biopsy model ensures efficient fluid exchange and drainage thanks to 392 openings

For IVD use



Tissue Cassette with one compartment	Biopsy Cassette with one compartment	Tissue Cassette with four compartments	Color	Qty/Cs
Cat. #	Cat. #	Cat. #		
M509-2	M510-2	M511-2	White	1500
M509-3	M510-3	M511-3	Pink	1500
M509-4	M510-4	M511-4	Green	1500
M509-5	M510-5	M511-5	Yellow	1500
M509-6	M510-6	M511-6	Blue	1500
M509-7	M510-7	M511-7	Peach	1500
M509-8	M510-8	M511-8	Tan	1500
M509-9	M510-9	M511-9	Gray	1500
M509-10	M510-10	M511-10	Lilac	1500
M509-11	M510-11	M511-11	Orange	1500
M509-12	M510-12	M511-12	Aqua	1500

Fluo Pink, Fluo Green and Fluo Yellow are also available. Minimum quantities apply. Contact us for more details.

## M511 SLIMSETTE™ Tissue Processing / Embedding Cassettes

For IVD use

Made of acetal

This model is similar to Series M509 but cassettes have four square compartments each measuring 13 mm. Cover and base have openings maximizing fluid exchange and ensuring proper drainage. Each case contains 3 dispenser boxes of 500 cassettes with covers assembled.



## M515 SWINGSETTE™ Tissue Processing / Embedding Cassettes

Made of acetal

These disposable plastic cassettes hold tissue specimens during processing and embedding, as well as in storage. Molded from a special high-density polymer, they keep specimens safely submerged in liquid and are resistant to the chemical action of histological solvents. The efficient flow-through slots maximize fluid exchange and ensure proper drainage.

This new model differs by the special hinge holding the base and cover together. This hinge allows cassettes to be opened and closed as often as necessary. The cover can be removed and re-inserted easily without danger of specimen loss.

Available in 11 colors.  
Each case contains 3 dispenser boxes of 500 cassettes.

For IVD use

A great alternative to the Richard-Allan and Surgipath Cassettes

### Anatomy of a Swingsette™

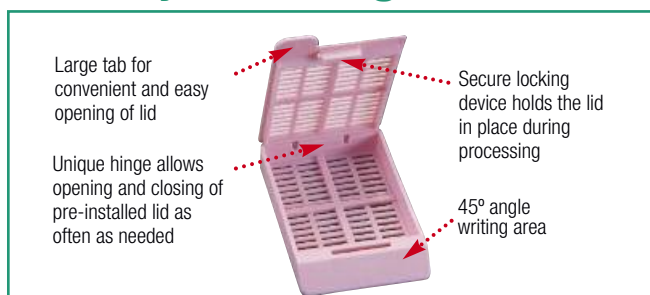

Tissue Cat. #	Biopsy Cat. #	Color	Qty/Cs
M515-2	M516-2	White	1500
M515-3	M516-3	Pink	1500
M515-4	M516-4	Green	1500
M515-5	M516-5	Yellow	1500
M515-6	M516-6	Blue	1500
M515-7	M516-7	Peach	1500
M515-8	M516-8	Tan	1500
M515-9	M516-9	Gray	1500
M515-10	M516-10	Lilac	1500
M515-11	M516-11	Orange	1500
M515-12	M516-12	Aqua	1500

Fluo Pink, Fluo Green and Fluo Yellow are also available.  
Minimum quantities apply. Contact us for more details.

## M516 SWINGSETTE™ Biopsy Processing / Embedding Cassettes

Made of acetal

These biopsy cassettes are similar to series M515 but especially designed to hold biopsy specimens during the processing / embedding process as well as in storage cabinets.

Each case contains three dispenser boxes of 500 cassettes.

For IVD use



## M517 SWINGSETTE™ Tissue Processing / Embedding Cassettes

Made of acetal

Most convenient for cassette labeling instruments since the covers are packaged separately in the case. These disposable plastic cassettes hold tissue specimens during processing and embedding, as well as in storage. Molded from a special high-density polymer, they keep specimens safely submerged in liquid and are resistant to the chemical action of histological solvents. The efficient flow-through slots maximize fluid exchange and ensure proper drainage.

This model differs by the special hinge that holds the base and cover together. This hinge allows cassettes to be opened and closed as often as necessary. The cover can be removed and re-inserted easily without danger of specimen loss. Available in 11 colors.

Each case contains two dispenser boxes of 500 cassettes and one dispenser box of 1000 covers.

For IVD use 

Tissue Cat. #	Biopsy Cat. #	Color	Qty/Cs
M517-2	M518-2	White	1000
M517-3	M518-3	Pink	1000
M517-4	M518-4	Green	1000
M517-5	M518-5	Yellow	1000
M517-6	M518-6	Blue	1000
M517-7	M518-7	Peach	1000
M517-8	M518-8	Tan	1000
M517-9	M518-9	Gray	1000
M517-10	M518-10	Lilac	1000
M517-11	M518-11	Orange	1000
M517-12	M518-12	Aqua	1000

Fluo Pink, Fluo Green and Fluo Yellow are also available. Minimum quantities apply. Contact us for more details.



Cassettes and lids packaged separately



Compatible with all cassette printers

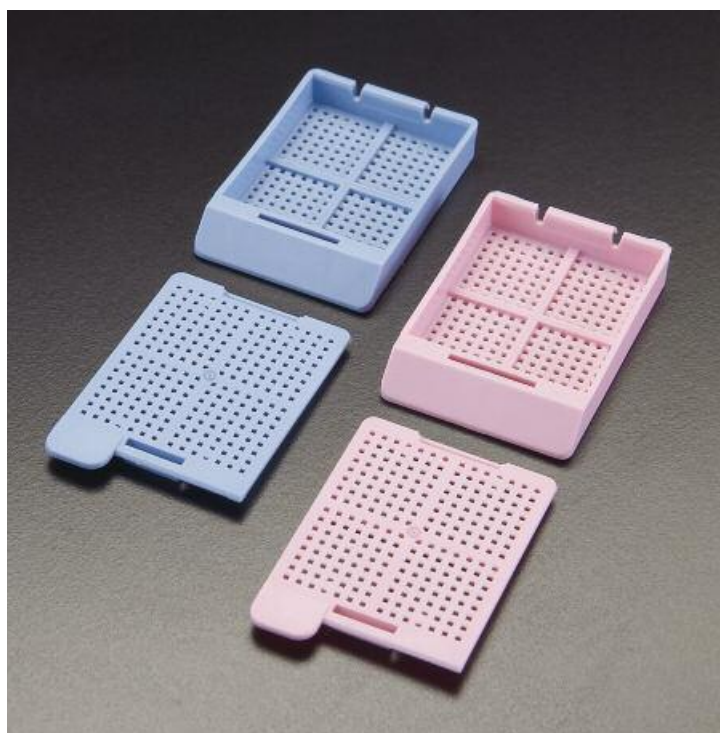

## M518 SWINGSETTE™ Biopsy Processing / Embedding Cassettes

Made of acetal

Most convenient for cassette labeling instruments since the covers are packaged separately in the case. These biopsy cassettes are similar to the M517 Series but are especially designed to hold biopsy specimens during the processing/embedding process as well as in storage cabinets.

Each case contains two dispenser boxes of 500 cassettes and one box of 1000 covers.

For IVD use 

### Close-up of the hinge



M515-M516 Series  
The cover is connected to the base.

M517-M518 Series  
The special hinge makes it easy to attach lid to base.

# CASSETTES IN SLEEVES

## M485SL & M486SL HISTOSETTE® II Cassettes in QuickLoad™ Sleeves

Made of acetal

Suitable for hoppers accepting plastic sleeves, these cassettes will load in cassette labeling instruments in one simple operation. Save time and money with these convenient sleeves of 75 unique Simport® cassettes. No more manual insertion, one cassette at a time. Just load the cassette sleeve in the hopper and you are ready for printing.

These specially designed cassettes belong to the world-wide known Simport® HISTOSETTE® II Series. Molded from a special high density polymer, these cassettes keep specimens safely submerged in liquid and are resistant to the chemical action of histological solvents. The efficient flow-through slots maximize fluid exchange and ensure proper drainage.

Two types of cassettes are offered in order to suit your particular needs: a regular tissue cassette and a biopsy model designed to hold small biopsy samples securely during the embedding process. Anterior printing area is at a 45° angle, offering an unobstructed view of the writing surface and making the cassette perfectly suitable to be used with cassette labeling instruments.

The one-piece disposable plastic cover eliminates the need for reusable steel lids. It can be opened and closed as often as necessary and it always relocks without danger of specimen loss. Available in 11 colors.

Each case contains 10 sleeves and 750 covers.

For IVD use

M485SL and M486SL Series are available worldwide. For a US distributor, please contact one of our Customer Service representatives.

## M482 & M483 HISTOSETTE® II Cassettes in E-Z Load™ Stacks

Made of acetal

This stack of cassettes allows you to load the Shur/Mark® Cassette Labeling Instruments in one simple operation. Save time and money with these convenient stacks of 50 unique Simport® cassettes. No more manual insertion, one cassette at a time. Just load the stack in the hopper, cut and remove the holding tie and you are ready for printing.

These specially designed cassettes belong to the world-wide known Simport® Histosette® II design. Molded from a special high density polymer, these cassettes keep specimens safely submerged in liquid and are totally resistant to the chemical action of histological solvents. The efficient flow-through slots maximize fluid exchange and ensure proper drainage.

Two types of cassettes are offered in order to suit your particular needs: a regular tissue cassette and a biopsy model designed to hold small biopsy samples securely during the embedding process. Anterior printing area is at a 45° angle.

### TISSUE CASSETTES (In stacks of 50)

Base Cat. #	Cover Cat. #	Color	Qty/Cs
M482-2BA	M482-2LI	White	2000
M482-3BA	M482-3LI	Pink	2000
M482-4BA	M482-4LI	Green	2000
M482-5BA	M482-5LI	Yellow	2000
M482-6BA	M482-6LI	Blue	2000
M482-7BA	M482-7LI	Peach	2000
M482-8BA	M482-8LI	Tan	2000
M482-9BA	M482-9LI	Gray	2000
M482-10BA	M482-10LI	Lilac	2000
M482-11BA	M482-11LI	Orange	2000
M482-12BA	M482-12LI	Aqua	2000

### BIOPSY CASSETTES (In stacks of 50)

Base Cat. #	Cover Cat. #	Color	Qty/Cs
M483-2BA	M483-2LI	White	2000
M483-3BA	M483-3LI	Pink	2000
M483-4BA	M483-4LI	Green	2000
M483-5BA	M483-5LI	Yellow	2000
M483-6BA	M483-6LI	Blue	2000
M483-7BA	M483-7LI	Peach	2000
M483-8BA	M483-8LI	Tan	2000
M483-9BA	M483-9LI	Gray	2000
M483-10BA	M483-10LI	Lilac	2000
M483-11BA	M483-11LI	Orange	2000
M483-12BA	M483-12LI	Aqua	2000

Fluo Pink, Fluo Green and Fluo Yellow are also available. Minimum quantities apply. Contact us for more details.



Compatible with ThermoFisher cassette printers

Tissue Cassette Cat. #	Biopsy Cassette Cat. #	Color	Qty/Cs
M485-2SL	M486-2SL	White	750
M485-3SL	M486-3SL	Pink	750
M485-4SL	M486-4SL	Green	750
M485-5SL	M486-5SL	Yellow	750
M485-6SL	M486-6SL	Blue	750
M485-7SL	M486-7SL	Peach	750
M485-8SL	M486-8SL	Tan	750
M485-9SL	M486-9SL	Gray	750
M485-10SL	M486-10SL	Lilac	750
M485-11SL	M486-11SL	Orange	750
M485-12SL	M486-12SL	Aqua	750

Fluo Pink, Fluo Green and Fluo Yellow are also available. Minimum quantities apply. Contact us for more details.

For IVD use



These cassettes can be used in this automatic labeling instrument.

CASSETTE BASES AND LIDS ARE ORDERED SEPARATELY.

## M507SL MICROMESH™ Biopsy Cassettes in QuickLoad™ Sleeves

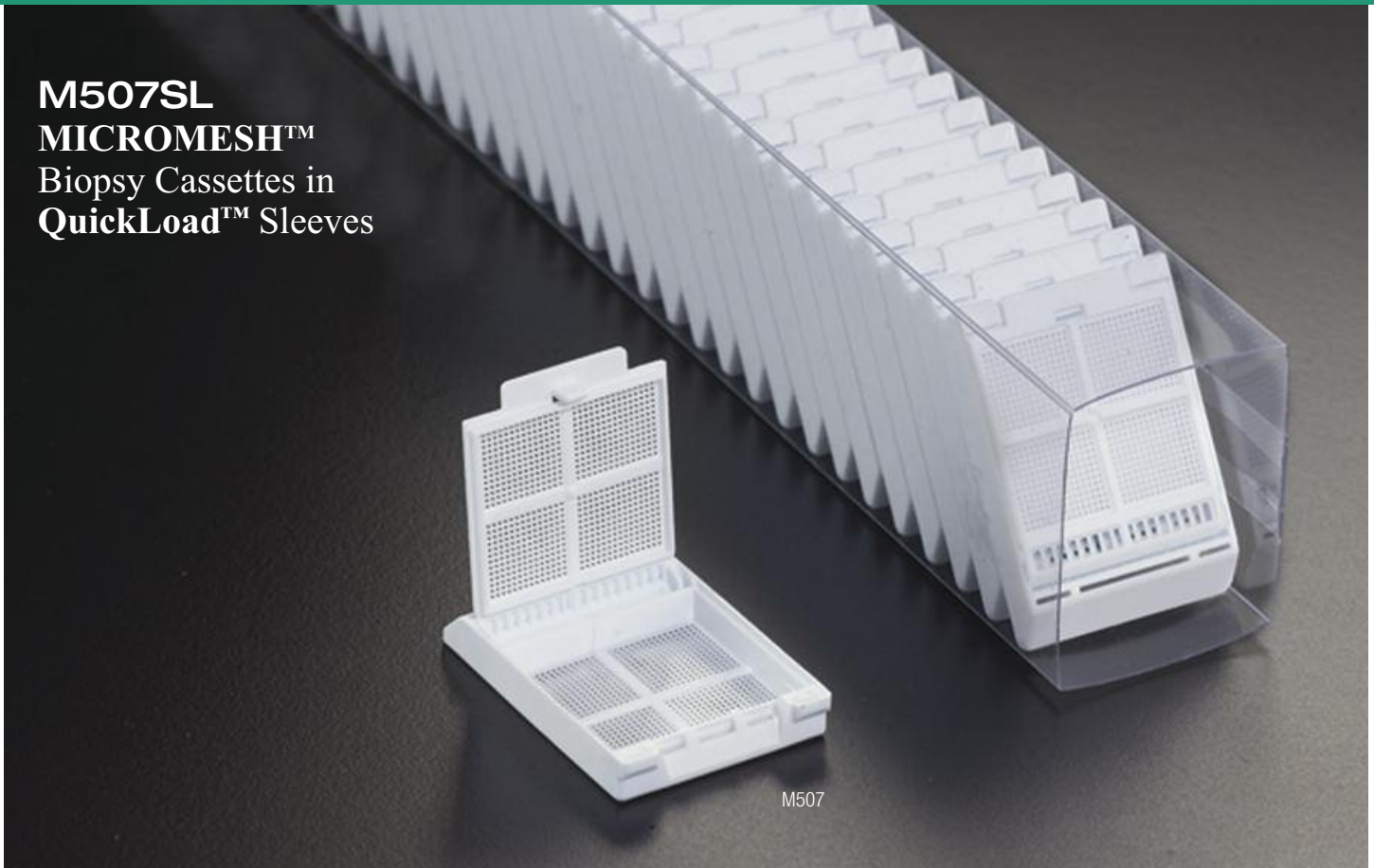

Made of acetal

Suitable for hoppers accepting plastic sleeves, these cassettes will load in cassette labeling instruments in one simple operation. Just load the 75-cassette QuickLoad™ sleeve in the hopper and you are ready for printing.

The Micromesh™ offers 0.38 mm square openings, and large anterior slots allowing for increased fluid exchange and faster sinking in liquids. No biopsy pads are necessary. These cassettes feature a recessed cover and a large square 27 mm compartment, perfect even for needle biopsies.

Molded from a special high density polymer, these cassettes keep specimens safely submerged in liquid and are resistant to the chemical action of histological solvents. The lid can be opened and closed as often as necessary and always relocks securely without danger of specimen loss. Anterior writing area is at a 45° angle to make the cassette more suitable to be used with automated cassette printers. Available in 11 colors. Each case contains 10 sleeves.

Cat. #	Color	Qty/Cs
M507-2SL	White	750
M507-3SL	Pink	750
M507-4SL	Green	750
M507-5SL	Yellow	750
M507-6SL	Blue	750
M507-7SL	Peach	750
M507-8SL	Tan	750
M507-9SL	Gray	750
M507-10SL	Lilac	750
M507-11SL	Orange	750
M507-12SL	Aqua	750

For IVD use

**NO BIOPSY PADS REQUIRED**

Lids are pre-mounted on cassettes

Fluo Pink, Fluo Green and Fluo Yellow are also available. Minimum quantities apply. Contact us for more details.

Compatible with ThermoFisher cassette printers



## Anatomy of a Micromesh™

A recessed cover is a great space saving feature, allowing more cassettes to be stacked in automatic labeling machines and storage drawers



Large anterior slots in both cassette and cover ensure that the Micromesh™ biopsy cassette will be submerged rapidly



Base and cover together have 1676 square openings (0.38 mm) allowing for a greatly improved fluid exchange

# CASSETTES IN SLEEVES

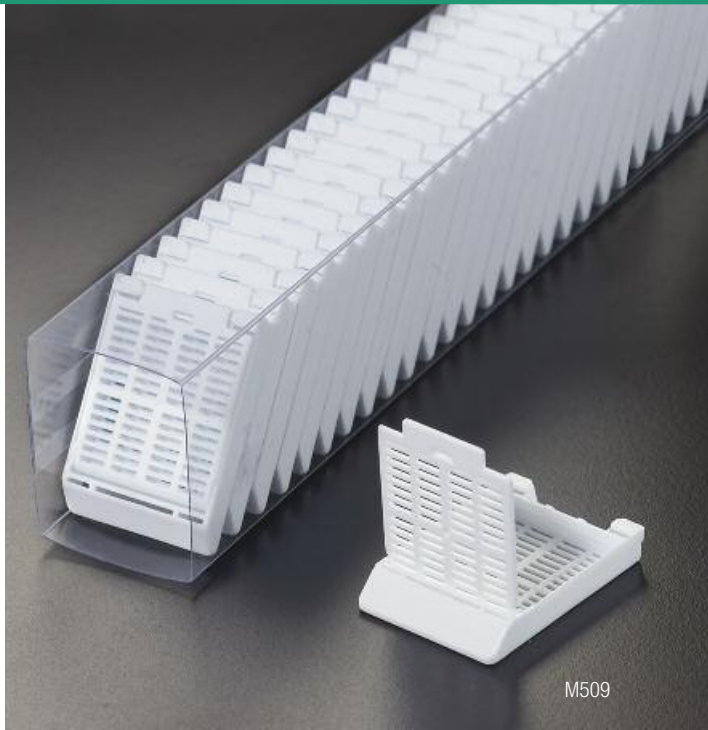

## M509SL SLIMSETTE™

### Tissue Cassettes in QuickLoad™ Sleeves

Made of acetal

The transparent sleeve allows viewing of cassettes in order to confirm there is no jam in the sleeve during the printing process.

This model is similar to the M507 cassette but is intended for tissue processing/embedding procedures. The efficient flow-through slots maximize fluid exchange and ensure proper drainage. Lids can be opened and closed as often as necessary and they always relock securely without danger of specimen loss. When ready for the embedding process, covers can conveniently be snapped off and discarded.

Anterior writing area at a 45° angle. Available in 11 colors. Each case contains 10 sleeves of 75 cassettes.

For IVD use



Lid already installed on cassette base

Tissue Cassette Cat. #	Biopsy Cassette Cat. #	Color	Qty/Cs
M509-2SL	M510-2SL	White	750
M509-3SL	M510-3SL	Pink	750
M509-4SL	M510-4SL	Green	750
M509-5SL	M510-5SL	Yellow	750
M509-6SL	M510-6SL	Blue	750
M509-7SL	M510-7SL	Peach	750
M509-8SL	M510-8SL	Tan	750
M509-9SL	M510-9SL	Gray	750
M509-10SL	M510-10SL	Lilac	750
M509-11SL	M510-11SL	Orange	750
M509-12SL	M510-12SL	Aqua	750

Fluo Pink, Fluo Green and Fluo Yellow are also available. Minimum quantities apply. Contact us for more details.

## M510SL SLIMSETTE™

### Biopsy Cassettes in QuickLoad™ Sleeves

Made of acetal

Suitable for hoppers accepting plastic sleeves, these biopsy cassettes will load in cassette labeling instruments in one simple operation. Just load the 75-cassette QuickLoad™ sleeve in the hopper and you are ready for printing.

Molded from a special high density polymer, these cassettes keep specimens safely submerged in liquid and are totally resistant to the chemical action of histological solvents. The lid can be opened and closed as often as necessary and always relocks securely without danger of specimen loss. Anterior writing area is at a 45° angle to make the cassette more suitable to be used with automated cassette printers. Available in 11 colors.

Cassettes are packaged in sleeves of 75. Each case contains 10 sleeves.

For IVD use

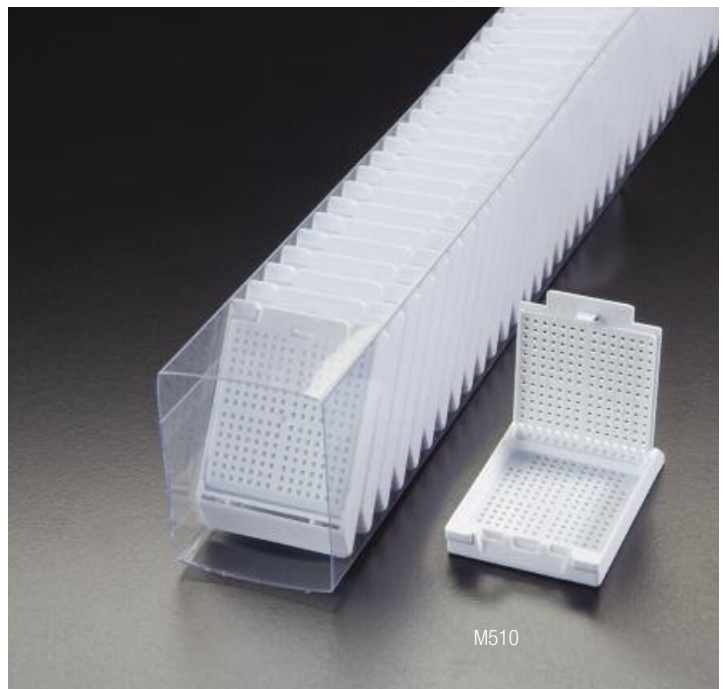

## M517SL SWINGSETTE™ Tissue Cassettes in QuickLoad™ Sleeves

Made of acetal

Suitable for hoppers accepting plastic sleeves, these tissue cassettes will load in cassette labeling instruments in one simple operation. Just load the 75-cassette QuickLoad™ sleeve in the hopper and you are ready for printing.

Molded from a special high density polymer, these cassettes keep specimens safely submerged in liquid and are resistant to the chemical action of histological solvents. The lid can be opened and closed as often as necessary and always relocks securely without danger of specimen loss. Anterior writing area is at a 45° angle to make the cassette more suitable to be used with automated cassette printers. Available in 11 colors.

Each case contains 10 sleeves of 75 cassettes and 10 bags of 75 lids.

For IVD use 

Tissue Cassette Cat. #	Biopsy Cassette Cat. #	Color	Qty/Cs
M517-2SL	M518-2SL	White	750
M517-3SL	M518-3SL	Pink	750
M517-4SL	M518-4SL	Green	750
M517-5SL	M518-5SL	Yellow	750
M517-6SL	M518-6SL	Blue	750
M517-7SL	M518-7SL	Peach	750
M517-8SL	M518-8SL	Tan	750
M517-9SL	M518-9SL	Gray	750
M517-10SL	M518-10SL	Lilac	750
M517-11SL	M518-11SL	Orange	750
M517-12SL	M518-12SL	Aqua	750

Fluo Pink, Fluo Green and Fluo Yellow are also available.  
Minimum quantities apply. Contact us for more details.



Have you ever considered  
Our Paraffin Block Mailer?  
See M477-6 on page 44.

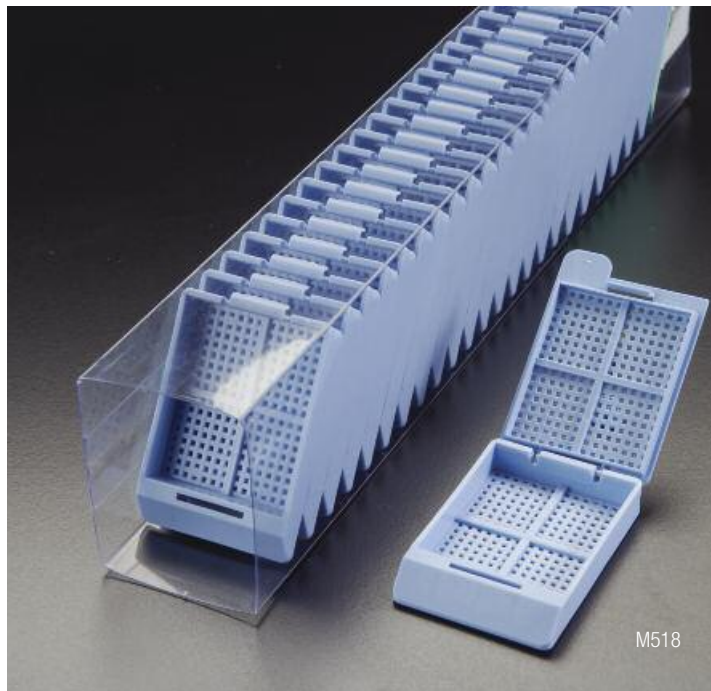

## M518SL SWINGSETTE™ Biopsy Cassettes in QuickLoad™ Sleeves

Made of acetal

These disposable plastic cassettes hold biopsy specimens during processing and embedding, as well as in storage. Molded from a special high-density polymer, they keep specimens safely submerged in liquid and are totally resistant to the chemical action of histological solvents. The efficient flow-through slots maximize fluid exchange and ensure proper drainage.

This new model differs by the special hinge holding the base and cover together. This hinge allows cassettes to be opened and closed as often as necessary. The cover can be removed and re-inserted easily without danger of specimen loss. Available in 11 colors.

Each case contains 10 sleeves of 75 cassettes and 10 bags of 75 lids.

For IVD use 

# CASSETTES IN STACKS

## M492T HISTOSETTE® II Tissue Cassettes in QuickLoad™ Stacks

Made of acetal

Specially made to be used with Leica and Sakura Ink Jet printers. Molded from a special high density acetal, they keep specimens safely submerged and are resistant to the chemical action of most solvents used in histology laboratories. The efficient flow-through slots maximize fluid exchange and ensure proper reagent drainage. The one-piece disposable plastic cover is pre-installed on each cassette and eliminates the need for reusable steel lids. The cover can be opened and closed as often as necessary and will always relock, reducing the possibility of specimen loss.

Cassettes are packaged in stacks of 40. Each case contains 50 stacks for a total of 2000 cassettes. Choose from 11 standard colors. The anterior printing area is at a 45° angle and offers an unobstructed view of the writing surface.

Cat. #	Color	Qty/Cs	Cat. #	Color	Qty/Cs
M492-2T	White	2000	M492-8T	Tan	2000
M492-3T	Pink	2000	M492-9T	Gray	2000
M492-4T	Green	2000	M492-10T	Lilac	2000
M492-5T	Yellow	2000	M492-11T	Orange	2000
M492-6T	Blue	2000	M492-12T	Aqua	2000
M492-7T	Peach	2000			

Compatible with Leica and Sakura cassette labeling instruments

For IVD use 

Available worldwide. For North America, please contact a Customer Service Representative.

## M493T HISTOSETTE® II Biopsy Cassettes in QuickLoad™ Stacks

Made of acetal

Histosette II® Biopsy Cassettes are similar to M492 Tissue Cassettes but specially designed to hold biopsy specimens. They have an attached lid that opens from the back of the cassette. The closed lids can be opened many times, always relocking securely. The anterior printing area is at a 45° angle and offers an unobstructed view of the writing surface.

Cassettes are packaged in stacks of 40. Each case contains 50 stacks for a total of 2000 cassettes. Choose from 11 standard colors.

Cat. #	Color	Qty/Cs	Cat. #	Color	Qty/Cs
M493-2T	White	2000	M493-8T	Tan	2000
M493-3T	Pink	2000	M493-9T	Gray	2000
M493-4T	Green	2000	M493-10T	Lilac	2000
M493-5T	Yellow	2000	M493-11T	Orange	2000
M493-6T	Blue	2000	M493-12T	Aqua	2000
M493-7T	Peach	2000			

Compatible with Leica and Sakura cassette labeling instruments



## M505T UNISETTE™ Tissue Cassettes in QuickLoad™ Stacks

Made of acetal

Molded from a special high density acetal, these tissue cassettes keep specimens safely submerged in liquid and are totally resistant to the chemical action of solvents used in histology laboratories. The efficient flow-through slots maximize fluid exchange and ensure proper drainage.

The one-piece snap-latch and hinge-lock design prevents early separation of base and lid and allows one-hand operation. Lids are attached in an open position for easy filling, but can be opened or closed as often as necessary and will always relock securely. The tab on the left front side makes opening easy. Lids are easily removed by pulling sideways. The anterior writing area is at a 35° angle. Cassettes are packaged in stacks of 40. Each case contains 25 stacks for a total of 1000 cassettes. Choose from 11 standard colors.

Cat. #	Color	Qty/Cs	Cat. #	Color	Qty/Cs
M505-2T	White	1000	M505-8T	Tan	1000
M505-3T	Pink	1000	M505-9T	Gray	1000
M505-4T	Green	1000	M505-10T	Lilac	1000
M505-5T	Yellow	1000	M505-11T	Orange	1000
M505-6T	Blue	1000	M505-12T	Aqua	1000
M505-7T	Peach	1000			

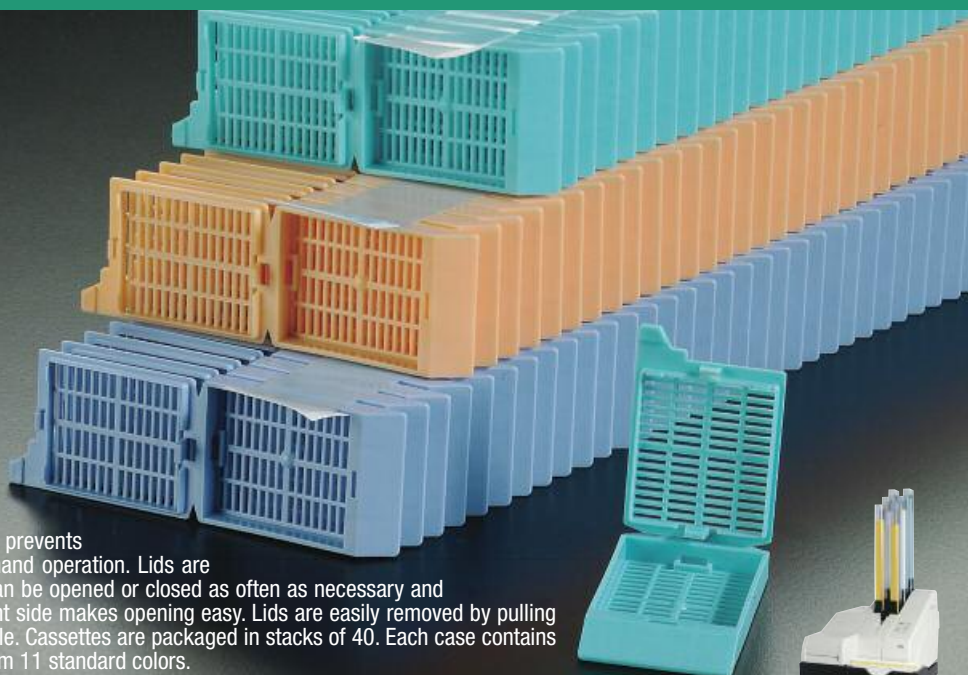

Compatible with Leica and Sakura cassette labeling instruments

Available worldwide. For North America, please contact a Customer Service Representative.

For IVD use

## M506T UNISETTE™ Biopsy Cassettes in QuickLoad™ Stacks

Made of acetal

The UNISETTE™ Biopsy Cassettes, made of acetal, are specially designed to hold biopsy specimens. One millimeter openings maximize fluid exchange and ensure proper drainage. The anterior writing area is at a 35° angle. The lids are attached, but arrive open for easy filling. There is a tab for opening on the left front side of the cassette lid. Lids are easily removed and will always relock securely.

Cassettes are packaged in stacks of 40. Each case contains 25 stacks for a total of 1000 cassettes. Choose from 11 standard colors.

Cat. #	Color	Qty/Cs	Cat. #	Color	Qty/Cs
M506-2T	White	1000	M506-8T	Tan	1000
M506-3T	Pink	1000	M506-9T	Gray	1000
M506-4T	Green	1000	M506-10T	Lilac	1000
M506-5T	Yellow	1000	M506-11T	Orange	1000
M506-6T	Blue	1000	M506-12T	Aqua	1000
M506-7T	Peach	1000			

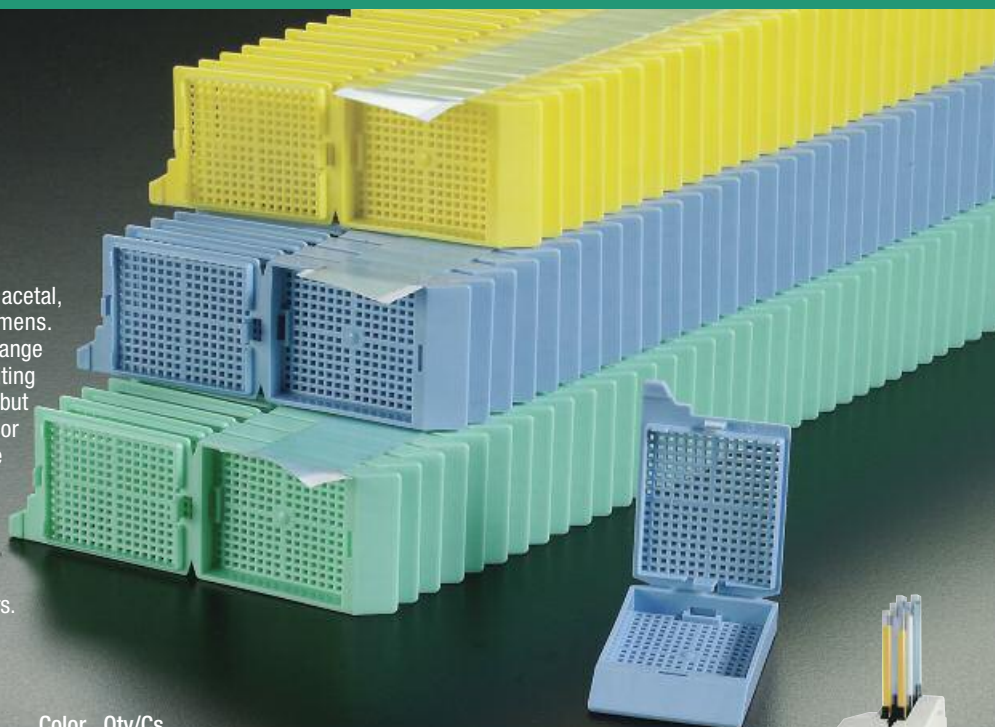

Compatible with Leica and Sakura cassette labeling instruments

# CASSETTES IN STACKS



## M507T MICROMESH™ Biopsy Cassettes in QuickLoad™ Stacks

Made of acetal

The MICROMESH™ offers 1676 square openings (0.38 mm) allowing for a greatly improved fluid exchange without having to use biopsy pads. Large anterior and posterior slots in both cassette and cover ensure that the MICROMESH™ Biopsy Cassette will sink rapidly. A large square compartment with a side measuring 27mm is perfect even for needle biopsies. The cover does not protrude above the cassette, a great space saving feature.

Molded from a special high density polymer, these patented cassettes keep specimens safely submerged in liquid and are totally resistant to the chemical action of histological solvents. The MICROMESH™ mesh ensures efficient fluid exchange and drainage. The one-piece integral lid eliminates the need for separate steel lids. They can be opened and closed as often as necessary and they always relock securely without danger of specimen loss. Anterior writing area is at a 45° angle to make the cassette more suitable to be used with automated cassette printers. Choose from 11 standard colors. Cassettes are packaged in stacks of 40. Each case contains 50 stacks for a total of 2000 cassettes.

Compatible with Leica and Sakura cassette labeling instruments



Cat. #	Color	Qty/Cs	Cat. #	Color	Qty/Cs
M507-2T	White	2000	M507-8T	Tan	2000
M507-3T	Pink	2000	M507-9T	Gray	2000
M507-4T	Green	2000	M507-10T	Lilac	2000
M507-5T	Yellow	2000	M507-11T	Orange	2000
M507-6T	Blue	2000	M507-12T	Aqua	2000
M507-7T	Peach	2000			

For IVD use

## M509T SLIMSETTE™ Tissue Cassettes in QuickLoad™ Stacks

Made of acetal

To be used with Leica and Sakura Ink Jet printers. Molded from a special high density acetal, they keep specimens safely submerged and are totally resistant to the chemical action of solvents used in histology laboratories. The efficient flow-through slots maximize fluid exchange and ensure proper reagent drainage. The cover does not protrude above the cassette, a great space saving feature.

Two types of cassettes are offered to suit your particular needs: a routine tissue cassette, and a biopsy cassette designed to hold small samples securely during processing. The anterior printing area is at a 45° angle and offers an unobstructed view of the writing surface.

The one-piece disposable plastic cover is pre-installed on each cassette and eliminates the need for reusable steel lids. The cover can be opened and closed as often as necessary and will always relock, reducing the possibility of specimen loss. Cassettes are packaged in stacks of 40. Each case contains 50 stacks for a total of 2000 cassettes. Choose from 11 standard colors.

Available worldwide. For North America, please contact a Customer Service Representative.

Compatible with Leica and Sakura cassette labeling instruments



Cat. #	Color	Qty/Cs	Cat. #	Color	Qty/Cs
M509-2T	White	2000	M509-8T	Tan	2000
M509-3T	Pink	2000	M509-9T	Gray	2000
M509-4T	Green	2000	M509-10T	Lilac	2000
M509-5T	Yellow	2000	M509-11T	Orange	2000
M509-6T	Blue	2000	M509-12T	Aqua	2000
M509-7T	Peach	2000			

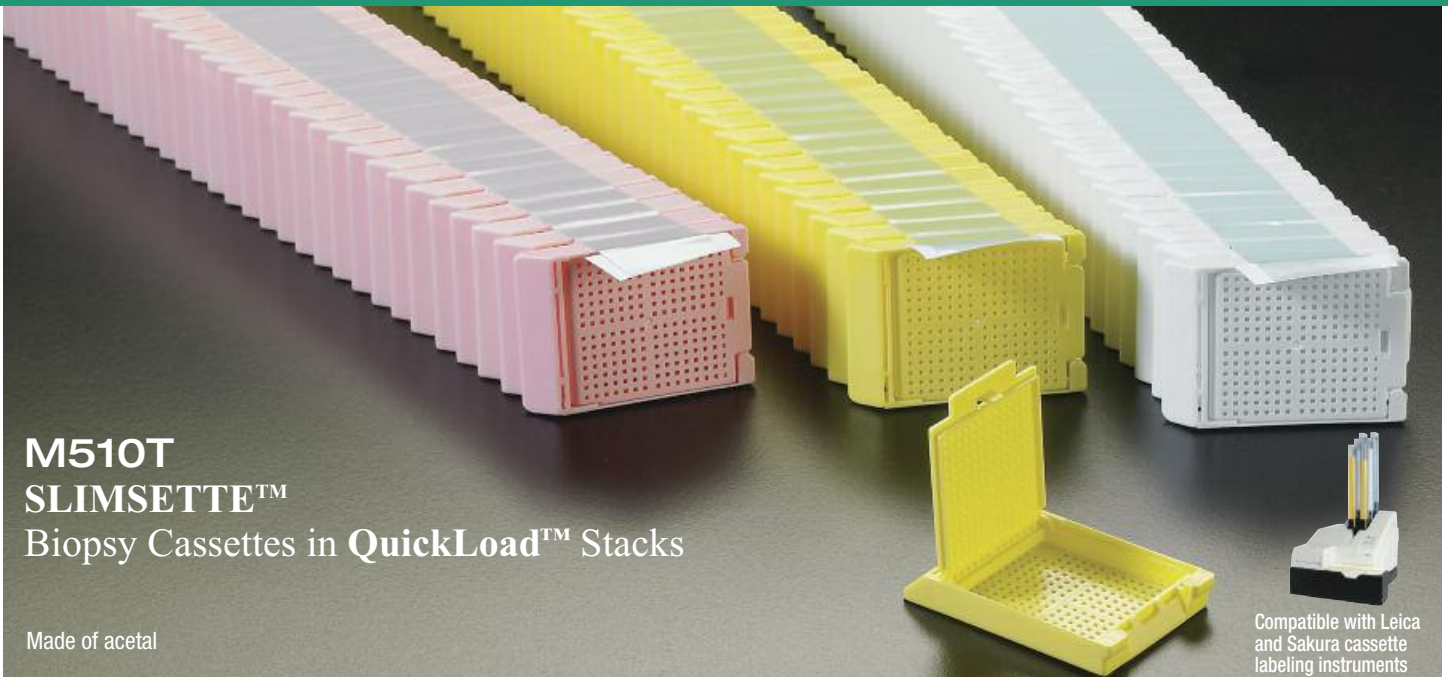

## M510T SLIMSETTE™ Biopsy Cassettes in QuickLoad™ Stacks

Made of acetal

Slimsette™ Biopsy Cassettes are similar to M509 Tissue Cassettes but are specially designed to hold biopsy specimens. They have an attached lid that opens from the back of the cassette. The lids arrive closed but can be opened many times, always relocking securely. The anterior printing area is at a 45° angle and offers an unobstructed view of the writing surface.

Cassettes are packaged in stacks of 40. Each case contains 50 stacks for a total of 2000 cassettes. Choose from 11 standard colors.

Cat. #	Color	Qty/Cs	Cat. #	Color	Qty/Cs
M510-2T	White	2000	M510-8T	Tan	2000
M510-3T	Pink	2000	M510-9T	Gray	2000
M510-4T	Green	2000	M510-10T	Lilac	2000
M510-5T	Yellow	2000	M510-11T	Orange	2000
M510-6T	Blue	2000	M510-12T	Aqua	2000
M510-7T	Peach	2000			

Compatible with Leica and Sakura cassette labeling instruments

For IVD use

Available worldwide. For North America, please contact a Customer Service Representative.

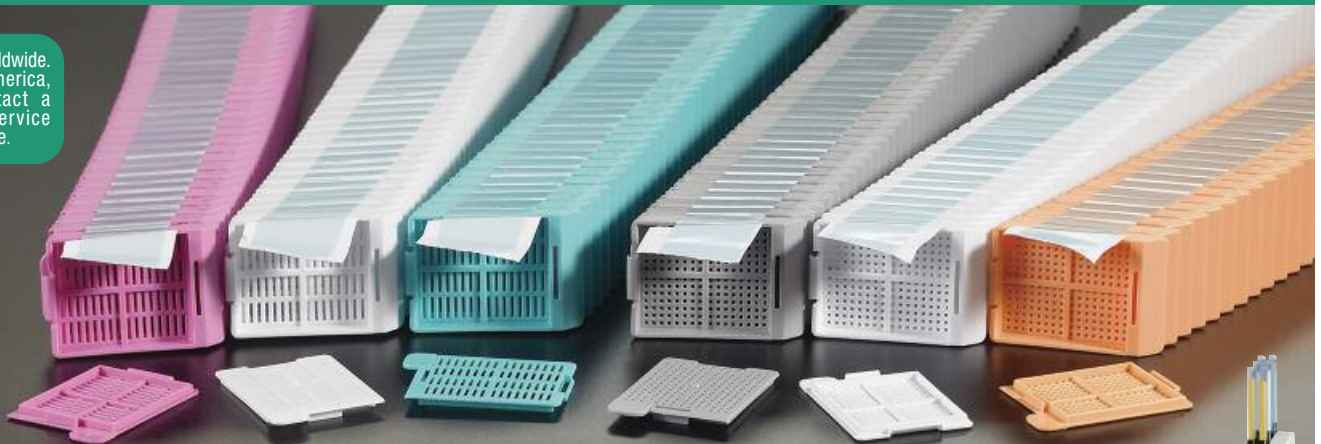

## M517T & M518T SWINGSETTE™ Tissue & Biopsy Cassettes in QuickLoad™ Stacks

Made of acetal

Our latest model suited for the Leica and Sakura labellers. These cassettes will also load in those cassette labeling instruments in one simple operation. Save time and money with these convenient stacks of 40 Simport® cassettes. Just load the cassette sleeve in the magazine and you are ready for printing.

These specially designed cassettes belong to the world-wide known Simport® Swingsette™ design. They differ by the special hinge that holds the base and cover together. This hinge allows the Swingsette™ to be opened and closed as often as necessary.

Two types of cassettes are offered in order to suit your particular needs: a regular tissue cassette and a biopsy model designed to hold small biopsy samples securely during the embedding process. Anterior printing area is at a 45° angle, offering an unobstructed view of the writing surface and making the cassette perfectly suitable to be used with cassette labeling instruments. Choose from 11 standard colors.

For Tissues Cat. #	For Biopsies Cat. #	Color	Qty/Cs
M517-2T	M518-2T	White	2000
M517-3T	M518-3T	Pink	2000
M517-4T	M518-4T	Green	2000
M517-5T	M518-5T	Yellow	2000
M517-6T	M518-6T	Blue	2000
M517-7T	M518-7T	Peach	2000
M517-8T	M518-8T	Tan	2000
M517-9T	M518-9T	Gray	2000
M517-10T	M518-10T	Lilac	2000
M517-11T	M518-11T	Orange	2000
M517-12T	M518-12T	Aqua	2000

Compatible with Leica and Sakura cassette labeling instruments

## M512

### MACROSETTE®

#### Processing / Embedding Cassettes (with lid)

Made of acetal

Disposable plastic cassettes designed to hold larger tissue specimens during the embedding process, as well as in a storage cabinet. Dimensions are exactly the same as the ones of a regular HISTOSETTE® cassette but the MACROSETTE® is twice as high (13 mm).

The one-piece integral lid eliminates the need for separate steel lids. It can be opened and closed as often as necessary and will always relock securely without danger of specimen loss. Large labeling areas are located on three sides of the cassettes for your convenience. Each case contains three dispenser boxes of 250 cassettes.

Dimensions: 40.1 x 28.5 x 13 mm H (1<sup>9</sup>/<sub>16</sub> x 1<sup>1</sup>/<sub>8</sub> x 1/2 in. H)

For IVD use 



Cat. #	Color	Qty/Cs
M512	White	750

## M475-10

### Disposable Deep Base Mold



Made of PVC

Designed especially for M512 MACROSETTE®. Thanks to the specially formulated plastic material, it offers excellent thermal exchange. It has a smooth interior finish and rounded corners facilitating specimen removal.

Cat. #	Size (mm)	Vol	Qty/Cs
M475-10	37 x 24 x 10	5 ml	500

## M513-2

### JUMBOSETTE®

#### Processing / Embedding Cassettes (with lid)

Made of acetal

The JUMBOSETTE™ is suitable for extra large tissue samples such as eyes, animal organs etc, thanks to its larger size. Will ensure efficient fluid exchange during the processing cycle. When utilised with a specially designed Base Mold, the cassette becomes the supporting structure of the paraffin block. A clamp adapter is available in order to support the JUMBOSETTE™. Dimensions: 3" x 2" x 3/4" (75 x 52 x 18 mm).

For IVD use 

Cat. #	Color	Qty/Cs
M513-2	White	100

Green, yellow and blue available on request. Minimum quantities apply.



## M474-7

### Reusable Base Mold for the JUMBOSETTE®

Made of Stainless Steel

This mold is suited for all applications in specimen embedding with the JUMBOSETTE™. Manufactured from high-quality stainless steel for optimal thermal conductivity, the mold has a highly polished surface for easy paraffin block removal. Reusable. Stackable for easy storage.



Cat. #	Size (mm)	Qty/Pk
M474-7	66 x 45 x 15	10



You can pile these up over 2 meters high.

## M495-6 Modular Storage Drawer

Made of high impact polystyrene

This drawer provides permanent storage & identification of up to 165 embedding rings or 250 cassettes per drawer. It is stackable to any convenient height, thanks to interlocking ridges on top and bottom. Made of high impact resistant plastic. Identification labels included.

Cat. #	Dimensions	Qty/Cs
M495-6	40.5 cm x 23 cm x 5.1 cm H (15 7/8 x 9 1/8 x 2 1/8 in. H)	6



## M495-7 Storage Drawer

Made of durable, waterproof, heavy-duty cardboard for long term storage. Requires minimal space. Label and cardboard separators are provided for each box allows recording of specimen number, date and type of specimen. Each box can store up to 165 embedding rings or 250 cassettes. Dimensions: 40.5 cm x 23 cm x 5.1 cm H (15 7/8 x 9 1/8 x 2 1/8 in. H)

Cat. #	Material	Qty/Cs
M495-7	Heavy-duty cardboard	12

## M474 Base Molds



Made of Stainless Steel

Sizes fit most cassettes. Superior thermal exchange. These molds are for all applications in specimen embedding with all styles of Embedding Rings and Cassettes. Manufactured from high-quality stainless steel for optimal thermal conductivity, the molds have a highly polished surface for easy paraffin block removal. Well corners are rounded for optimal paraffin ribboning.

Cat. #	Size (mm)	Qty/Pk
M474-1	7 x 7 x 5	12
M474-2	15 x 15 x 5	12
M474-3	24 x 24 x 5	12
M474-4	30 x 24 x 5	12
M474-5	37 x 24 x 5	12

## M475 Disposable Base Molds

Made of PVC

Simport® disposable base molds offer ease and convenience of operation. They are inexpensive enough to be discarded after use, yet strong enough to be reused. Thanks to the specially formulated plastic material, they offer excellent thermal exchange. They have a smooth interior finish and rounded corners facilitating specimen removal. Also, they are available in the same variety of sizes as metal molds and can be used with the same styles or types of cassettes and embedding rings. Each case contains two dispenser boxes of 500 base molds.

Cat. #	Size (mm)	Qty/Cs
M475-1	7 x 7 x 5	1000
M475-2	15 x 15 x 5	1000
M475-3	24 x 24 x 5	1000
M475-4	30 x 24 x 5	1000
M475-5	37 x 24 x 5	1000

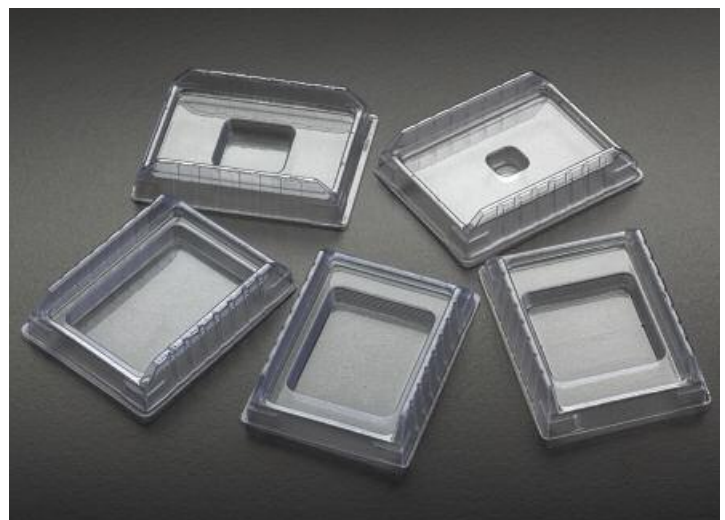

## M476 Biopsy Foam Pads

Made of polyester urethane foam

Simport® biopsy foam pads are used to hold biopsies in place and prevent them from being lost during processing. They are made of a specially formulated foam which is always verified for consistency throughout in order to achieve optimum solvent flow. Biopsy samples are sandwiched between two foam pads and are placed either in tissue capsules or cassettes\* with metal or plastic lids. M476-4 model is to be used with the Micromesh™ and Slimsette™ Cassettes. M476-5 is specially suited for the Histosette® II Cassettes on page 26 & 27. Will resist temperatures from -40 °C to 121 °C.

Cat. #	For use with	Size (mm)	Qty/Pk	Qty/Cs
M476-1	Cassettes	30.2 x 25.4 x 2	1000	10 000
M476-2	Small capsules	25.4 x 2.7	1000	10 000
M476-3	Large capsules	34.6 x 2	1000	10 000
M476-4*	Slimsette	27.4 x 25.4 x 2	1000	10 000
M476-5**	Histosette® II	30.2 x 25.4 x 2	1000	10 000

\*Use with the following Simport® cassette Series: M509 and M510.\*\* Use with the following Simport® cassette Series: M492, M493, M485 and M486.



M476-5 is specially suited for the Histosette® II Cassettes on page 26 & 27.

## M478 Biopsy Bags

Made of nylon

These sturdy biopsy bags are made of white nylon thin mesh (0.3 mm diameter), reducing the risk of specimen loss during processing. While solvent resistant, they provide great tissue safety and excellent fluid exchange. In order to ease specimen removal, bags can be peeled open. All seams are heat-sealed. Available in three sizes.

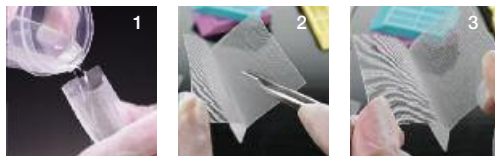

1. Transfer the biopsy in the bag with a pair of forceps OR empty both fixative and specimen in the bag. Let the fixative drip out of the bag in a container, close the bag and insert in a cassette.
2. After processing, remove bag from cassette. Open with care, extending the edges.
3. Extract biopsy and proceed with your embedding.



Cat. #	Dimensions (mm)	Qty/Pk
M478-1	30 X 50	1000
M478-2	45 X 75	1000
M478-3	75 X 95	500



While providing maximum tissue safety, you can conveniently see through the biopsy bags.



## M477-6 Paraffin Block Mailer, 6 compartments

Made of PVC

At last, a transport container made especially for paraffin blocks. Sturdy and easy to use, the Simport® mailer is transparent for easy viewing of contents. It can be used for handling and shipping up to 6 blocks as needed, while having to keep only one model of block mailer in inventory. The attached cover is easy to close but very secure when closed. Suitable for all regular models of tissue and biopsy cassettes.

Cat. #	Dimensions	Qty/Cs
M477-6	134 x 141 x 29 mm H (5 1/4 x 5 5/8 x 1 1/8 in. H)	50



## M470 & M471 Tissue Capsules

Made of polypropylene

These capsules are suitable for holding tissue samples during processing. The lids have a frosted write-on area for sample identification and an open mesh area to facilitate fluid exchange. The entire surface of the base is also an open mesh. The lid snaps securely on the base, eliminating the risk of tissue loss during processing.

For IVD use

Cat. #	Size (mm)	Color	Qty/Cs
M470	28 x 5 H	White	1000
M471	38 x 10 H	White	1000

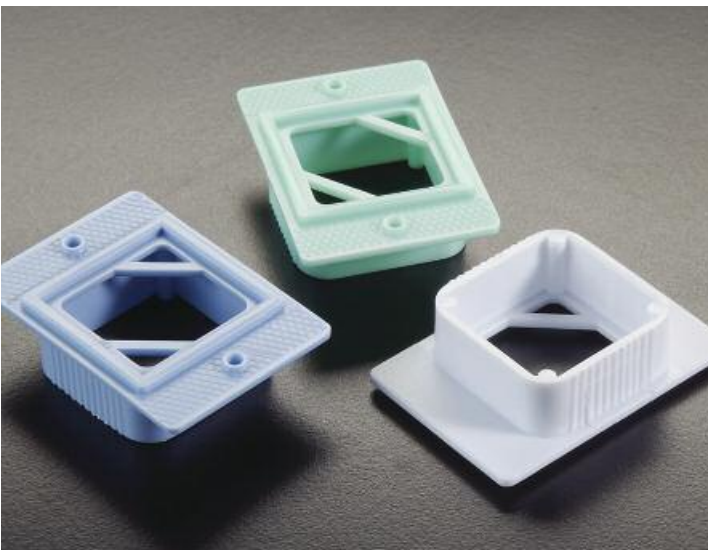

## M460 Embedding Rings

Made of high impact polystyrene

For IVD use

Embedding rings are suitable for holding and identifying tissue sample blocks and fit well in microtome chuck adapters. The etched writing surface on the ring is marked with an identification number and placed on top of the sample block. Additional paraffin is poured into the base mold to cement the ring onto the tissue block. The embedding ring securely holds the tissue sample in the microtome chuck adapter for sectioning and then identifies the sample while in storage. Rings are available in different colors. Each case contains 4 dispenser boxes of 250 rings.

Cat. #	Color	Qty/Box	Qty/Cs
M460	White	250	1000
M460-3	Pink	250	1000
M460-4	Green	250	1000
M460-5	Yellow	250	1000
M460-6	Blue	250	1000

## M590BK Cassette Labeler Thermal Printing Foil

This hot foil tape is used on the Thermo Scientific PrintMate and MicroWriter, RA Lamb and TBS Shurmark cassette labelers. Will print up to 20,000 cassettes per roll, subject to the amount of data being printed on each cassette. Dimensions: 1 1/8" wide x 400' long (28.6mm wide x 122m long).

Cat. #	Color	Qty/Cs
M590BK	Black	5



## M495-12 Write-ON™ Marker Pen

This pen is specially suited to be used on anterior surfaces and sides of Histology Cassettes. Ink will dry almost instantly. Ink withstands temperatures up to 195 °C and is resistant to solvents.



Cat. #	Color	Qty/Pk
M495-12	Black	10

## M795-1 Diamond Stylus for Microscope Slide Labelers

This diamond stylus is perfectly suited for the Thermo Scientific PrintMate and MicroWriter, RA Lamb and TBS Shurmark microscope slide labelers. Manufactured with a consistent even coating of diamond dust. The 2.35mm shaft is made from stainless steel.



Cat. #	Color	Qty/Pk
M795-1	Diamond Stylus	6

# SLIDE STORAGE

## A MODERN APPROACH TO SLIDE FILING

### M700-50 SlideFile™ Jr. Storage System

This rack is also available separately. See M710-50

Unobstructed front writing surface

Base made of high impact polystyrene / Cover made of polystyrene

The Junior model can hold up to 200 slides per unit in just 860 cm<sup>3</sup> (53 cu. in.) and is stackable for space efficient storage. Each SlideFile™ Jr. includes a slide box and a removable tray. A tinted hinged cover makes the contents of the box easy to see at a glance. The base is available in five different colors to help slide classification and to minimize the possibility of sample mix-up.

The key to the SlideFile™ Jr. is a removable tray inside the storage box having fifty individual numbered slots. All slides are stored upright for easier insertion and removal. Simply tilt them forward and backward with one finger to easily and rapidly pick up the slide you need. A unique feature with this system is to be able to read bar codes without having to remove the slides from the box.

For space saving purposes, you can double the amount of slides simply by storing two slides per slot. And for maximum storage space, simply remove the tray and line up 200 slides in 3 rows for long term storage. Will resist temperatures between -80 °C and +80 °C. Not autoclavable.

Dimensions: 82 x 140 x 86 mm H (3 1/4 x 5 1/2 x 3 3/8 in. H)



Read bar codes without having to remove slides from tray.



Simply tilt slides forward or backward with one finger to easily and rapidly pick up the one you need.



Remove slide tray and it will store up to 200 slides.



Removable tray makes it easy to carry slides around and store up to 50 slides vertically (1 per slot) or 100 slides vertically (2 per slot)



Two index cards numbered from 1 to 50 are supplied with each box.

Cat. #	Color	Qty/Pk	Qty/Cs
M700-50B	Blue	1	10
M700-50G	Green	1	10
M700-50P	Pink	1	10
M700-50W	White	1	10
M700-50Y	Yellow	1	10

### M710-50 DrainRack™ Jr.

Made of high impact polystyrene

Can hold up to 100 microscope slides in 50 individual numbered slots. Will resist temperatures -80 °C and +80 °C. Not autoclavable.

Cat. #	Color	Qty/Pk	Qty/Cs
M710-50B	Blue	1	10
M710-50G	Green	1	10
M710-50P	Pink	1	10
M710-50W	White	1	10
M710-50Y	Yellow	1	10





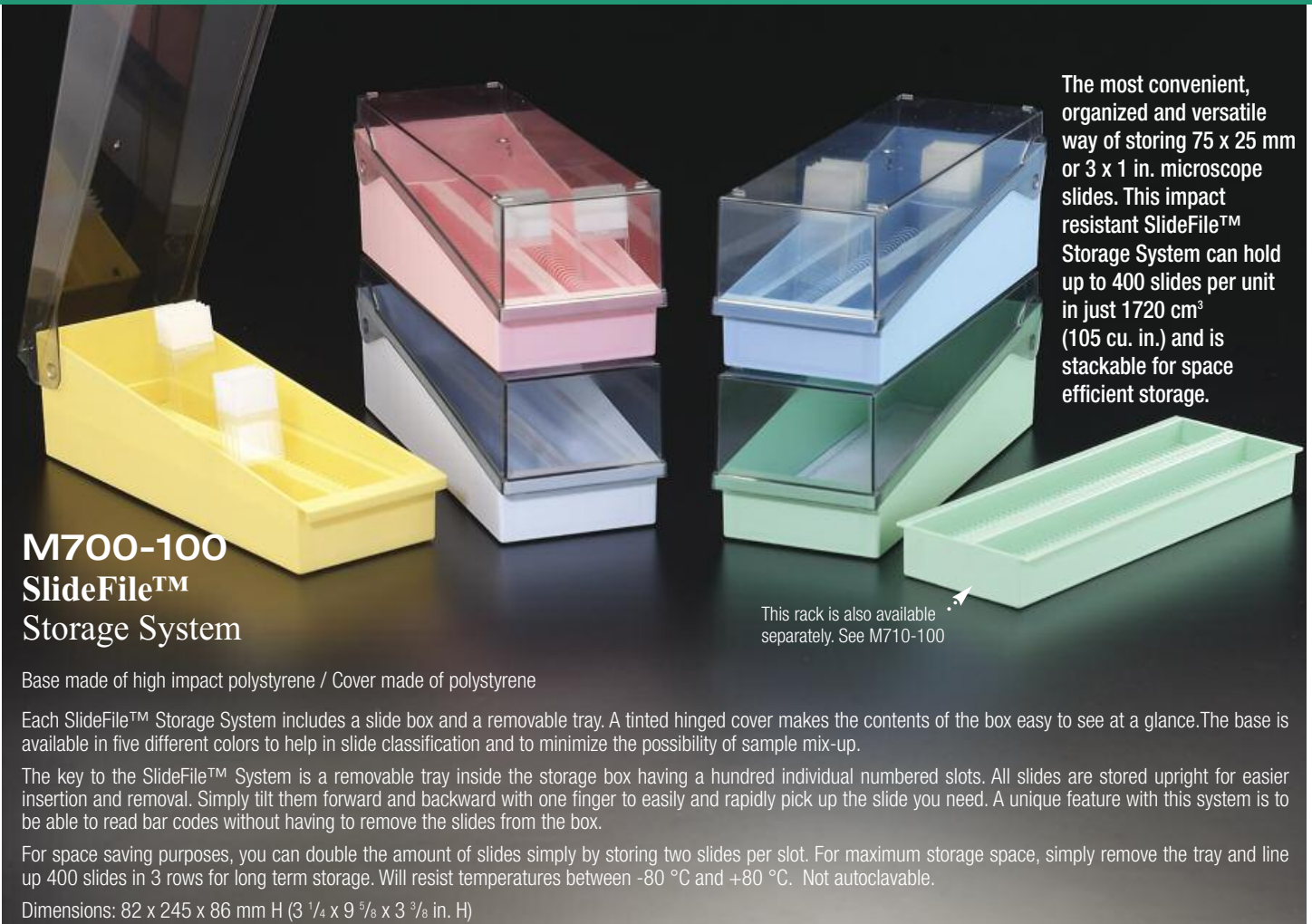

The most convenient, organized and versatile way of storing 75 x 25 mm or 3 x 1 in. microscope slides. This impact resistant SlideFile™ Storage System can hold up to 400 slides per unit in just 1720 cm³ (105 cu. in.) and is stackable for space efficient storage.

## M700-100 SlideFile™ Storage System

Base made of high impact polystyrene / Cover made of polystyrene

Each SlideFile™ Storage System includes a slide box and a removable tray. A tinted hinged cover makes the contents of the box easy to see at a glance. The base is available in five different colors to help in slide classification and to minimize the possibility of sample mix-up.

The key to the SlideFile™ System is a removable tray inside the storage box having a hundred individual numbered slots. All slides are stored upright for easier insertion and removal. Simply tilt them forward and backward with one finger to easily and rapidly pick up the slide you need. A unique feature with this system is to be able to read bar codes without having to remove the slides from the box.

For space saving purposes, you can double the amount of slides stored simply by storing two slides per slot. For maximum storage space, simply remove the tray and line up 400 slides in 3 rows for long term storage. Will resist temperatures between -80 °C and +80 °C. Not autoclavable.

Dimensions: 82 x 245 x 86 mm H (3 1/4 x 9 5/8 x 3 3/8 in. H)

This rack is also available separately. See M710-100

Cat. #	Color	Qty/Pk	Qty/Cs
M700-100B	Blue	1	10
M700-100G	Green	1	10
M700-100P	Pink	1	10
M700-100W	White	1	10
M700-100Y	Yellow	1	10



Read bar codes without having to remove slides from tray.

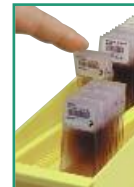

Simply tilt slides forward or backward with one finger to easily and rapidly pick up the one you need.



Remove slide tray and store up to 400 slides.



Removable tray makes it easy to carry slides around and store up to 100 slides vertically (1 per slot) or 200 slides vertically (2 per slot)



Two index cards numbered from 1 to 100 are supplied with each box.

## M710-100 DrainRack™



Dimensions: 75 x 231 x 25 mm H (3 x 9 x 1 in. H)

Easy-to-read numbers from 1 to 100 identifying each slot

Made of high impact polystyrene

This rugged tray used as a drain rack can hold up to 200 microscope slides in 100 individual numbered slots. All slides are stored upright for easier insertion and removal. Simply tilt them forward and backward with one finger to easily and rapidly pick up the slide you need. A unique feature with the DrainRack™ is to be able to read bar codes without having to remove the slides from the box.

For space saving purposes, you can double the amount of slides stored simply by storing 2 slides per slot, giving you a capacity of 200 slides instead of 100. Not autoclavable.

Cat. #	Color	Qty/Pk	Qty/Cs
M710-100B	Blue	1	10
M710-100G	Green	1	10
M710-100P	Pink	1	10
M710-100W	White	1	10
M710-100Y	Yellow	1	10

## M620 DissecTable™ Dissecting Board

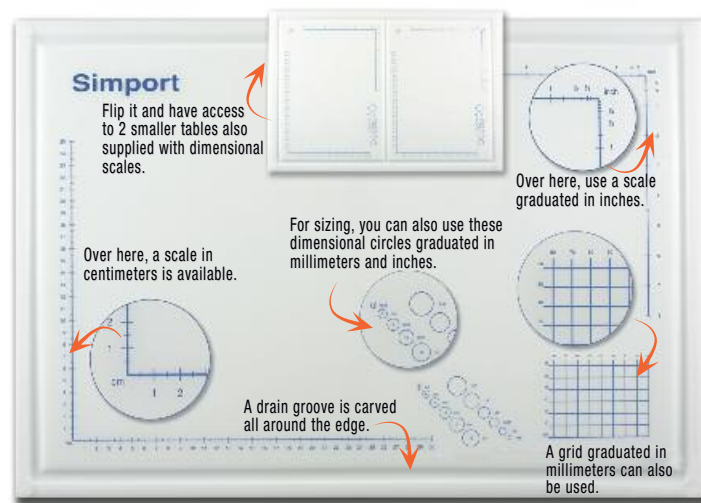

Patent applied for

Made of high-density polyethylene

A new and unique approach makes this dissecting board more convenient than any other found on the market today. It is no more necessary to buy different sizes as this board offers a large surface on one side and two smaller ones on the other side.

Made of heavy-duty stain resistant thick polyethylene, it will last for years to come without changing shape, bending or swelling. Will not dull fine surgical blades. In order to contain fluids, a drain groove is carved all around the edge of the DissecTable™.

On one side, you will find a large cutting area including dimensional scales in inches and centimeters, along with a 60 x 80 mm grid made of 48 x 10 mm squares. Six dimensional circles are also printed from 1/8 to 9/8 in. and 4 to 14 mm in diameter. Flip it over and the other side offers two cutting boards half the size with the same dimensional features printed on each one of them. All corners have rubber feet giving more stability to the working surface.

Dimensions: 575 mm x 400 mm x 12.5 mm (23 x 16 x 1/2 in H)

Cat. #	Description	Qty/Cs
M620	DissecTable™	1



## M618 DissecTable™ Jr. Dissecting Board

Made of high-density polyethylene

A smaller DissecTable™ is also available with the same features and benefits as the M620. Perfect for smaller counter area. Dimensions: 330.2 mm x 279.4 mm x 12.5 mm (13 x 11 x 1/2 in H)

Cat. #	Description	Qty/Cs
M618	DissecTable™ Jr.	1



Each base raises the DissecTable by 91 mm (3 5/8 in.)



## M625 Board Base (for use with M620)

Made of high impact polystyrene

To make dissecting more comfortable, this heavy-duty base is used to elevate the DissecTable™ Board to the right height. The bases are stackable and will not move sideways during the dissecting work. The base will also retain excess fluid if necessary.

Dimensions: 481 mm x 656 mm x 91 mm (19 1/4 x 26 1/4 x 3 5/8 in H)

Cat. #	Description	Qty/Cs
M625	DissecTable™ Board Base	1

## THE *DispoCut*<sup>EM</sup> DISSECTING BOARD

Can be used  
on both sides

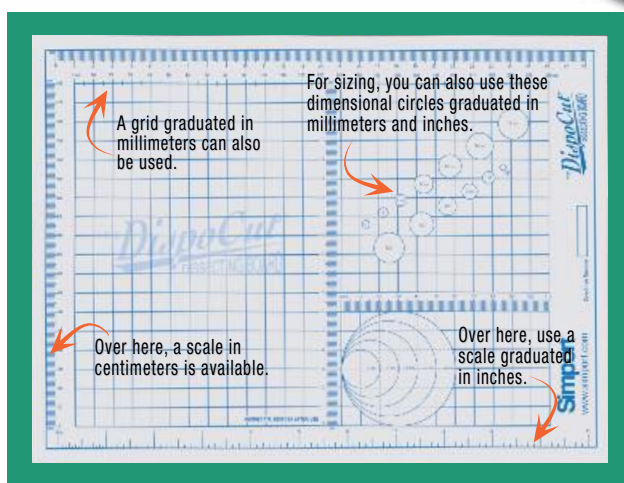

Have you ever considered  
our Modular Storage Drawer?  
See M495-6 on page 43.



### M630

#### Disposable Dissecting Board

The DispoCut™ Disposable Dissecting Board is strong yet inexpensive enough to throw away. It is especially developed to provide a clean, safer and more efficient way of handling infectious tissue specimens for the pathologist. It can be used on both sides, a great money saving feature. Printed with helpful imperial and metric dimensional scales in inches, centimeters and millimeters. Available in three sizes to accommodate small biopsies to large gross anatomy procedures.

DispoCut™ is extrusion made using a copolymer resin in order to increase impact and temperature performance. Copolymer resins are also used because they retain the ability to be flexed an unlimited number of times without breaking. Chemically, DispoCut is inert. At regular temperatures most oils, solvents and water have no effect, allowing it to perform under adverse weather conditions or as a product component exposed to harsh chemicals.

Each surface has many conveniently located rulers including seven dimensional circles from 4 to 16 mm in diameter and five larger ones from 2 to 6 cm in diameter. Surface will not dull knives. Perfect for use with dissecting pins. All sizes of DispoCut™ Disposable Dissecting Boards are ideal for pathology labs, medical schools, classroom dissections, forensic labs, medical research labs, pharmaceutical labs, surgery and more.

Temperature performance range: -27 °C to 71 °C (17 °F to 160 °F)

Melting point: 162 °C (324 °F)

Sterilization: DispoCut™ may be wiped down with alcohol with no effect on the material. DispoCut™ is being autoclaved (in excess of 3 years) in many situations. There are some extreme settings which will be damaging and we suggest a trial to determine performance in your equipment. Ethylene oxide gas sterilization has no effect of any kind on DispoCut™ and may be repeated any number of times.

Physical Data: Specific Gravity 0.90 - 0.96. Essentially insoluble in water.

Cat. #	Description	Qty/Pk	Qty/Cs
M630-1	152 x 203 mm (6 x 8 in.)	24	96
M630-2	229 x 305 mm (9 x 12 in.)	12	48
M630-3	305 x 483 mm (12 x 19 in.)	12	24

# SLIDE STAINING

## M900 EasyDip™ Slide Staining System



Slide Staining Rack sold separately

Made of acetal

Finally a user-friendly approach for staining your microscope slides, the EasyDip™ Slide Staining System has two components: a square staining jar and a 12-position vertical slide rack. As an extra benefit, they are available in 5 different colors to help better identifying contents or applications.

The staining jar being made of resistant acetal plastic will not break like most glass jars do. It will resist to most staining agents including alcohol and xylene (but not phenol, iodine or ferric chloride). The wide stable base offers greater stability while the inside is recessed, allowing for a smaller reagent volume of only 80 ml. Easy to clean and no metals to corrode. Ideal for special stains, frozen sections and special processes. Dimensions: 64 x 76 x 92 mm H (2 1/2 x 3 x 3 5/8 in. H).

### EasyDip™ Slide Staining Jar

Cat. #	Color	Qty/Cs
M900-12B	Blue	6
M900-12G	Green	6
M900-12P	Pink	6
M900-12W	White	6
M900-12Y	Yellow	6
M900-12AS	Assorted*	1 Kit

\*This kit includes 5 jars (one of each color) and 1 rack (M905-12DGY).



425 x 102 x 38 mm H  
(16 3/4 x 4 x 1 1/2 in. H)

## M906AS EasyDip™ Slide Staining Kit

This kit includes one anodized aluminum rack along with six assorted color jars (two white ones) and one M905-12DGY Slide Staining Rack. Also available without staining jars and staining rack (see M906)



Cat. #	Description	Qty/Cs
M906AS	EasyDip Kit	1
M906	Aluminum Holder only	1

## M905-12DGY EasyDip™ Slide Staining Rack



Made of acetal

The EasyDip™ Slide Staining Rack will hold up to 12 microscope slides with dimensions such as 75 x 25 mm (3 x 1 in.) and even 76 x 26 mm and with a thickness of 1.0 and 1.2 mm. The slides fit into individual slots for free passage and rapid drainage of staining fluids. Available in dark gray only. Dimensions: 60 x 64 x 97 mm H (2 1/4 x 2 1/2 x 3 3/4 in. H)

Cat. #	Color	Qty/Cs
M905-12DGY	Dark Gray	6



A handle is permanently attached to the rack for easy insertion and removal.



Staining rack is placed at an angle to facilitate draining of slides.



Vertical rack eases slide removal without using forceps.



Slides are fully secured when lid is upright. Rotate it sideways to allow their easy removal.

## M920 StainTray™ Slide Staining System

Made of ABS Plastic

Another user friendly approach to immunohisto-chemistry staining. This tray is also suitable not only for routine staining requiring a humid chamber but is also ideal for Hematology, Cytology and Microbiology laboratories. Manipulation is made safe and easy by using only one hand.

The StainTray™ has a black base made of tough ABS plastic withstanding a wide range of chemicals (Avoid chlorinated hydrocarbons). It will accept up to 20 slides on four plastic rails covered with a polymer strip to perfectly hold slides even if tray is held at an angle. When humidity is needed, wells between rails will hold up to one ml of water securely without splashing. Middle wells will hold up to 2 ml each. Rails are raised not only to avoid water touching the slides but to make them more easily retrieveable. The base will also hold excess stain solution dripping from the slides. Four rubber feet ensure greater base stability. Units are stackable for space saving purposes.

Two covers are available:

- A clear one allowing for visual examination. Made of PETG with a temperature range of -20 °C to +60 °C.
- A black lid for fluorescent work. Made of ABS with a temperature range of -80 °C to +80 °C



**DO NOT USE  
WITH ACETONE**

Dimensions: 38 x 24 x 4.5 cm H. (15 x 9 3/8 x 1 3/4 in. H)

Cat. #	Description	Capacity	Qty/Cs
M920-1	Base with Clear Lid	20 slides	1
M920-2	Base with Black Lid	20 slides	1
M921-1	Clear Lid only for M920	–	1
M921-2	Black Lid only for M920	–	1

## M918 StainTray™ Slide Staining System

Made of ABS Plastic

This 10-slide StainTray™ offers the same great features and benefits as the M920 Model. Dimensions with cover: 24 x 24 x 4.5 cm H (9 3/8 x 9 3/8 x 1 3/4 in. H)

Cat. #	Description	Capacity	Qty/Cs
M918-1	Base with Clear Lid	10 slides	1
M918-2	Base with Black Lid	10 slides	1
M919-1	Clear Lid only for M918	–	1
M919-2	Black Lid only for M918	–	1



Plastic rails are covered with a polymer strip holding slides perfectly even if tray is held at an angle.



Wells between rails can be used to hold water for techniques needing a humid environment.



A black lid for fluorescent work. Made of ABS with a temperature range of -80 °C to +80 °C.

If you **TRULY** care about your sample,  
let us help you **PROTECT** its integrity!



Can also be used as a slide staining jar

## M950 LockMailer™ Microscope Slide Jar



Jar made of Polypropylene  
Closure made of High Density Polyethylene

At least a tamper evident multi purpose container for mailing, staining or storing microscope slides.

Constructed of extra-strong and clear polypropylene, it will hold up to 4 standard 3 x 1 in. or 75 x 25 mm slides vertically. Inside channels are slotted to keep slides safely separated. Perfect also for slide conveyors and specimen slide transport between the doctor's office and the lab.

It incorporates a unique tamper evident leakproof screw cap ensuring your peace of mind during transport or storage situations where someone might have manipulated your slides without your prior knowledge. Can also be used without the tamperproof locking mechanism. For color coding purposes, use a Capinsert™ (see T345 Series) that may be inserted on top of closure. Ten different colors are available.

The container is designed for maximum stability on a bench top while having an internal volume of only 12 ml.

Dimensions: 35 x 87 mm H (1 3/8 in. x 3 7/16 in. H)

Cat. #	Color	Qty/Pk	Qty/Cs
M950-4MA	Magenta	100	500

## How to use the LockMailer™



Push up the attached tab on side of vial.



Make sure it firmly clicks in place.



Screw on tamperproof cap all the way.



When opening the vial, the tamper evident ring will detach itself from the cap.



The LockMailer™ can also be used without the tamper evident feature.

## T345 Color Coding CAPINSERT™

Made of polypropylene

The Capinsert™ is used to color code a multitude of Simport® products according to your specific needs. It is inserted on top of the closure and has a write-on frosted area for sample identification.



Cat. #	Color	Cat. #	Color	Qty/Bag
T345B	Blue	T345P	Pink	500
T345GY	Gray	T345R	Red	500
T345G	Green	T345V	Violet	500
T345L	Lilac	T345W	White	500
T345O	Orange	T345Y	Yellow	500
	* Blue, lilac, red, yellow and white	T345AS	Assorted*	500

## M800 UniMailer™ Slide Mailer

Made of high impact polystyrene



- 1 Slides fit perfectly to avoid any vibrations and breaking during transport.
- 2 Ship as many slides as needed, using only one type of slide mailer.
- 3 A special locking tab keeps UniMailer™ slide mailers securely in place.
- 4 Through holes, you can attach ID label or tamper evident tie.
- 5 Three writing surfaces for proper slide identification.
- 6 Strong plastic ensures rigidity and avoids any slide breakage.
- 7 Great for accessing one slide at a time while other slides are being kept well protected.

For many years now, noticeable improvements on the design of slide mailers have been scarce. Following many suggestions from users in the lab field, Simport® is now proud to come out with the UniMailer™, a truly versatile model which can easily be used for handling and shipping one or as many slides as needed, while having to keep only one model in inventory.

The UniMailer™ is a one-slide tray allowing the use of as many as necessary according to the number of slides to be mailed. Not only do they fit snugly on top of each other but they are also secured by an innovative locking mechanism. You may also want to insert a tamper evident tie or attach an ID label.

Designed to accommodate 25 x 75 mm and 1 x 3 in. slides with or without cover glasses, they can also be used to provide safe storage for those valuable slides you want to protect. It provides for multiple reuse or single use disposability.

Each tray allows placing the slide in a horizontal position for full visibility. Slides can easily be inserted with an exact fit to avoid any breaking during transport. When pressed on either side while in the UniMailer™, they will pop-up for easy removal.

Identification can be made on three sides or on top. Made of an almost unbreakable plastic, they are available in many popular pastel colors for easy identification. Packed in bag of fifty slide mailers. Will resist temperatures between -80 °C and +80 °C.

Dimensions: 89 x 29 x 6 mm H (3 1/2 x 1 3/8 x 1/4 in. H)

Cat. #	Color	Qty/Pk	Qty/Cs
M800-100B	Blue	50	200
M800-100G	Green	50	200
M800-100P	Pink	50	200
M800-100W	White	50	200
M800-100Y	Yellow	50	200

Not only do UniMailer™ slide mailers fit snugly on top of each other but are secured by an innovative locking mechanism.

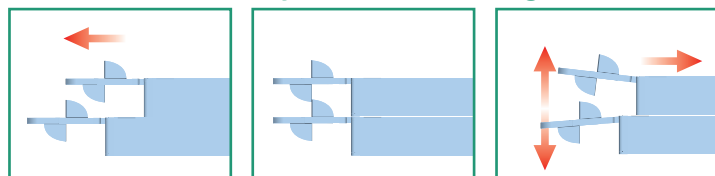

To close, slide upper UniMailer™ forward until locking pins are engaged.

Locking mechanism is now functional.

To open, insert finger between two locking tabs and slide back upper UniMailer™.

### The UniMailer™ is easy to use



Identify content by writing on sides.



Place slide in UniMailer™



Place another slide mailer on top and slide forward until a click is heard.



If desired, you can attach a tamper evident tie.



To open, slightly lift front tab to disconnect lock and slide back upper UniMailer™.



Press on slide to lift and remove.

**Tamper Evident**



## M960 HISTOTAINER™ I

### TAMPER EVIDENT Prefilled Specimen Containers, 50% Filled with 10% Neutral Buffered Formalin

Container made of polypropylene  
Closure made of polyethylene

Especially designed for collection, transport and storage of histology specimens, Simport® offers shatter resistant polypropylene containers, eliminating most problems of leakage and evaporation. The magenta lids are ribbed for easy opening when hands are wet or gloved while the jars are stackable for easy, safe storage and translucent to allow specimens to be viewed without opening. The closures are manufactured from virgin polyethylene with a unique integrated leak-resistant seal. Container's vertical walls offer excellent rigidity.

The uniqueness of the HistoTainer™ I is that it incorporates an innovative tamper evident screw cap ensuring your peace of mind during transport or storage situations where someone might have manipulated the specimen without your prior knowledge. Can also be used without using the tamper evident locking mechanism. For color coding purposes, use a Capinsert™ (see T345 Series) on top of closure. Ten different colors are available.

Both containers and caps are manufactured without the use of plasticisers or mold release agents. All material used in manufacture are free from latex. All containers are 95 kPa compliant. Available in many sizes from 20 to 120 ml. Packaging in trays of 24, cases of 96.

The Simport® HistoTainer™ I is half filled with 10% Neutral Buffered Formalin as a fixative. 10% Neutral Buffered Formalin penetrates quickly, but fixes slowly. The Simport® Formalin is enhanced by a buffering capacity optimizing histological results by light microscopy and immunohistochemistry.

Cat. #	Packaging	Volume	Qty/Tray	Qty/Cs
M960-20FMA	Tamper Evident – Internal Trays	20 ml	24	96
M960-40FMA	Tamper Evident – Internal Trays	40 ml	24	96
M960-60FMA	Tamper Evident – Internal Trays	60 ml	24	96
M960-90FMA	Tamper Evident – Internal Trays	90 ml	24	96
M960-120FMA	Tamper Evident – Internal Trays	120 ml	24	96



## How to use the HistoTainer™ I



Remove Screw Cap.

Place sample in container.

Push up the attached tab on side of container. Make sure it firmly clicks in place.

Screw cap completely on container.



When opening the container, the tamper evident ring will detach itself from the cap.

The HistoTainer™ can also be used without the tamper evident feature.

As a cassette holder, the 40 ml HistoTainer™ M960-40MA containing 20 ml of 10% Formalin, is the ideal size container to transport up to four tissue samples pre-inserted in processing / embedding cassettes.

M960 Series packaged in sturdy cardboard boxes with handles for easy carrying.

## Anatomy of the HistoTainer™ I

- Ridges around base offer a better grip during opening and closing.
- Warning label has space for patient identification.
- Insertion of a Capinsert™ allows color coding identification of contents.
- Molded ridges around lid make it easy to open and close.
- Tamper evident sealing ring for better sample protection.
- Specially designed locking tab to ensure a perfect tamper evident seal.
- 10% Neutral Buffered Formalin helps to protect sample integrity.





## With Conventional Closure



## M961 HISTOTAINER™ II

### NON Tamper Evident Prefilled Specimen Containers, 50% Filled with a Choice of Fixatives



Container made of polypropylene / Closure made of polyethylene

Especially designed for collection, transport and storage of histology specimens, Simport® offers shatter resistant polypropylene containers, eliminating most problems of leakage and evaporation. Containers are manufactured from virgin, translucent polypropylene. The white lids are ribbed for easy opening when hands are wet or gloved while the jars are stackable for easy, safe storage. Jars are translucent and specimens can be viewed without having to open the lid. Closures are manufactured from virgin polyethylene with a unique integrated leak-resistant seal. Container's vertical walls offer excellent rigidity. For color coding purposes, use a Capinsert™ (see T345 Series) on top of closure. Ten different colors are available.

Both containers and caps are manufactured without the use of plasticisers or mold release agents. All materials used in manufacturing are free from latex. Containers are 95 kPa compliant. Available in many sizes from 20 to 120 ml. Packaging is offered in trays of 24, cases of 96.

The HistoTainer™ II is half filled with a choice of fixatives. 10% Neutral Buffered Formalin penetrates quickly, but fixes slowly. The Formalin is enhanced by a buffering capacity optimizing histological results by light microscopy and immunohistochemistry. Bouin, Hollande and Zinc Formalin fixatives are also available. Please contact Simport for minimum ordering quantities.



M961 Series packaged in sturdy cardboard boxes with handles for easy carrying.



Warning label has space for patient identification

Cat. #	Volume	Fixative	Qty/Tray	Qty/Cs
M961-20FW	20 ml	Formalin	24	96
M961-20BW	20 ml	Bouin	24	96
M961-20HW	20 ml	Hollande	24	96
M961-20ZW	20 ml	Zinc Formalin	24	96
M961-40FW	40 ml	Formalin	24	96
M961-60FW	60 ml	Formalin	24	96
M961-60BW	60 ml	Bouin	24	96
M961-60HW	60 ml	Hollande	24	96
M961-60ZW	60 ml	Zinc Formalin	24	96
M961-90FW	90 ml	Formalin	24	96
M961-120FW	120 ml	Formalin	24	96

For Capinsert™ details, please refer to T345 on page 52.



# CoreDish®

Multiple Biopsy Containers  
Half Prefilled with 10% Formalin

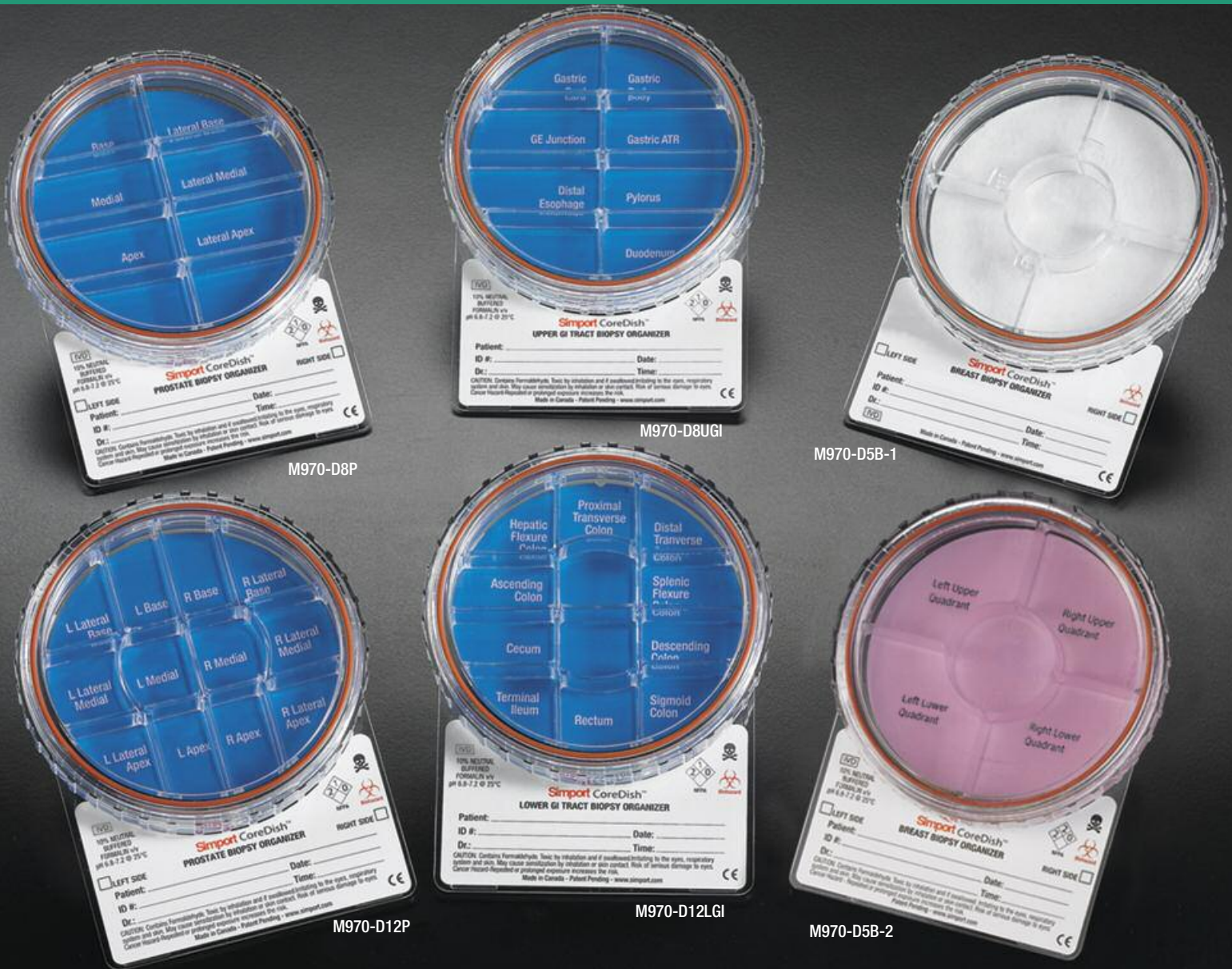

Made of polystyrene

Few recommendations concerning how the biopsies should be handled have been published. Performing a large number of biopsies means an increase in the number of containers handled and consequently a technical overload of the transmission network, which occurs without any financial counterpart. A new approach had to be developed in order to increase productivity.

Simport® is proud to offer a multi-compartment container in the shape of a dish and half prefilled with 10% Neutral Buffered Formalin, for holding and transporting biopsies. It is supplied with a leakproof closure with o-ring ensuring total protection of contents. **The Simport® CoreDish® measures only 15 x 95 mm in diameter.** Each compartment is clearly identified to allow proper placement and visualization of the biopsy being inserted. **Thanks to the CoreDish® it is no more necessary to use a multitude of individual containers, thereby reducing risks of confusion.** The Simport® CoreDish® offers many configurations in order to hold different biopsies of the breast, prostate, upper GI tract and lower GI tract. A label allows essential information to be written such as patient I.D., doctor, date and time. **The CoreDish® is also available without formalin. See series M971.**

For IVD use





## M970-D5B-1

**BREAST BIOPSY CONTAINER** For separation, imaging and transport of core needle specimens

Designed specifically for radiography, separation, imaging and transport of core needle breast biopsies. Special absorbent liner keeps specimens moist (when saline solution is added) prior to radiography while helping to attenuate the x-ray beam. Four compartments are clearly identified (3, 6, 9 and 12) and the radiolucent numbers show up clearly on the radiograph. Formalin may be added prior to transportation to pathology for analysis. An area for writing patient information is provided on the label. Leakproof seal, thanks to o-ring lid, allows for safe and easy transport of the specimens from collection to analysis. **Not available in USA.**

Cat. #	For	Compartments	Prefilled	Qty/Pk	Qty/Cs
M970-D5B-1	Breast	5	NO	1	10



## M970-D5B-2

**BREAST BIOPSY CONTAINER**

Simport® is proud to offer a multi-compartment container (out of five compartments, four are labelled: Left Upper Quadrant, Right Upper Quadrant, Left Lower Quadrant, Right Lower Quadrant) in the shape of a dish and half prefilled with 10% Neutral Buffered Formalin for holding and transporting biopsies. It conforms to OSHA directives. Each compartment is clearly identified to allow proper placement and visualization of the breast biopsy being inserted. A writing area for patient information is provided. Leakproof seal, thanks to o-ring lid, allows for safe and easy transport of the specimens from collection to analysis.

Cat. #	For	Compartments	Prefilled	Qty/Pk	Qty/Cs
M970-D5B-2	Breast	5	YES	1	10
M971-D5B-2	Breast	5	NO	1	10



## M970-D8P

**PROSTATE BIOPSY CONTAINER**

For prostate biopsies. Eight compartments. Leakproof seal thanks to o-ring lid. An area for patient information is provided. Six labeled compartments: Base, Lateral Base, Medial, Lateral Medial, Apex, Lateral Apex. Leakproof seal, thanks to o-ring lid, allows for safe and easy transport of the specimens from collection to analysis.

Cat. #	For	Compartments	Prefilled	Qty/Pk	Qty/Cs
M970-D8P	Prostate	8	YES	1	10
M971-D8P	Prostate	8	NO	1	10



## M970-D8UGI

**UPPER GI TRACK BIOPSY CONTAINER**

For upper GI track biopsies. Eight compartments. Leakproof seal thanks to o-ring lid. An area for patient information is provided. Seven labeled compartments: Gastric Card, Gastric Body, GE Junction, Gastric ATR, Distal Esophage, Pylorus, Duodenum. Leakproof seal, thanks to o-ring lid, allows for safe and easy transport of the specimens from collection to analysis.

Cat. #	For	Compartments	Prefilled	Qty/Pk	Qty/Cs
M970-D8UGI	Upper Gi Tract	8	YES	1	10
M971-D8UGI	Upper Gi Tract	8	NO	1	10



## M970-D12LGI

**LOWER GI TRACK BIOPSY CONTAINER**

For lower GI track biopsies. Twelve compartments. Leakproof seal thanks to o-ring lid. An area for patient information is provided. Ten labeled compartments: Proximal Flexure Colon, Hepatic Flexure Colon, Distal Transverse Colon, Ascending Colon, Splenic flexure Colon, Cecum, Descending Colon, Terminal Ileum, Rectum, Sigmoid Colon. Leakproof seal, thanks to o-ring lid, allows for safe and easy transport of the specimens from collection to analysis.

Cat. #	For	Compartments	Prefilled	Qty/Pk	Qty/Cs
M970-D12LGI	Lower Gi Tract	12	YES	1	10
M971-D12LGI	Lower Gi Tract	12	NO	1	10



## M970-D12P

**PROSTATE BIOPSY CONTAINER**

For prostate biopsies. Twelve compartments. Leakproof seal thanks to o-ring lid. An area for patient information is provided. Twelve labeled compartments: L Base, R Base, L Lateral Base, R Lateral Base, L Lateral Medial, L Medial, R Medial, R Lateral Medial, L Lateral Apex, L Apex, R Apex, R Lateral Apex. Leakproof seal, thanks to o-ring lid, allows for safe and easy transport of the specimens from collection to analysis.

Cat. #	For	Compartments	Prefilled	Qty/Pk	Qty/Cs
M970-D12P	Prostate	12	YES	1	10
M971-D12P	Prostate	12	NO	1	10

## CoreDish®

### GENERAL PURPOSE MULTIPLE BIOPSY CONTAINERS



#### M970-D5

5-COMPARTMENT BIOPSY CONTAINER

Made of polystyrene

Performing a large number of biopsies means an increase in the number of containers handled and consequently a technical overload of the transmission network, which occurs without any financial counterpart. A new approach had to be developed in order to increase productivity. Simport® is proud to offer a five-compartment container in the shape of a dish and half prefilled with 10% Neutral Buffered Formalin, for holding and transporting biopsies. It is supplied with a leakproof screw closure with o-ring ensuring total protection of contents. A writing area for patient information is provided. Compartments are numbered from 1 to 5.

Cat. #	For	Compartments	Prefilled	Qty/Pk	Qty/Cs
M970-D5	General purpose	5	YES	1	10
M971-D5	General purpose	5	NO	1	10



#### M970-D8

8-COMPARTMENT BIOPSY CONTAINER

Made of polystyrene

Simport® is proud to offer a multi-compartment container for up to 8 biopsies. The screw on lid incorporates an o-ring in order to make it leakproof and protect its contents. The CoreDish® conforms to OSHA directives. An area for patient information is provided on the label. Compartments are numbered from 1 to 8.

Cat. #	For	Compartments	Prefilled	Qty/Pk	Qty/Cs
M970-D8	General purpose	8	YES	1	10
M971-D8	General purpose	8	NO	1	10



#### M970-D12

12-COMPARTMENT BIOPSY CONTAINER

Made of polystyrene

This model will contain up to twelve biopsies. The screw on lid incorporates an o-ring in order to make it leakproof and protect its contents. The CoreDish® conforms to OSHA directives. Compartments are numbered from 1 to 12.

Cat. #	For	Compartments	Prefilled	Qty/Pk	Qty/Cs
M970-D12	General purpose	12	YES	1	10
M971-D12	General purpose	12	NO	1	10



A security label is supplied to ensure integrity of contents from collection stage to reopening of CoreDish®.

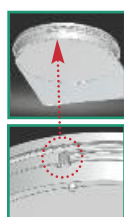

To close, turn clockwise until you feel a firm stop.



#### M975

**The CorePicker™**

Made of polystyrene

A practical tool and a great help to pick up and handle biopsies out of the CoreDish®. Packed in tamperproof resealable bags.

Cat. #	Length	Qty/Bag	Qty/Pk
M975	53 mm (2 1/8 in.)	25	125



#### M976

**Shipping Box for CoreDish®**

Made of cardboard

This sturdy and easy-to-assemble shipping box is most convenient for transporting or mailing the Simport® CoreDish®.

Cat. #	Description	Qty/Pk
M976	Cardboard Box	10

## M750-20 SlideFolder™

Base made of high impact polystyrene / Hinged doors made of polystyrene

The SlideFolder™ will hold up to twenty standard microscope slides 75 mm x 25 mm (3 x 1 in.) and is made of two parts: a base holding the slides horizontally offering numbered spaces for easy identification, and transparent doors which can either cover the slides or be swung behind the SlideFolder™ for space saving purposes.

The base is available in 5 different colors, allowing color-coding classification of the slides. Each slide location is identified with a number from 1 to 20. Removal of slides is made easy simply by pressing on one end, which will automatically lift the other end.

The two transparent hinged covers offer a full view of each slide without having to remove it from its position in the SlideFolder™ and allows easy reading of ID labels with or without an optical bar code reader. All units are stackable and take minimum space on laboratory tables or shelves. Will resist temperatures between -80 °C and +80 °C. Not autoclavable.

Dimensions: 192 x 295 x 11 mm H (7<sup>9</sup>/<sub>16</sub> X 11<sup>11</sup>/<sub>16</sub> X 7<sup>7</sup>/<sub>16</sub> in. H)



For light sensitive slides, use M752-20WOP SlideFolder™ with opaque doors.

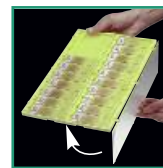

For easier access to slides, simply swing the transparent hinged covers behind the SlideFolder™.



Easy slide removal by pressing down on one end and lifting it from the other.

Cat. #	Color	Qty/Cs
M750-20B	Blue	10
M750-20G	Green	10
M750-20GY	Gray	10
M750-20W	White	10
M750-20Y	Yellow	10
M750-20AS	Assorted (two of each color)	10

Cat. #	Color	Qty/Cs
M752-20WOP	Opaque doors and white base	10

## M755-20 SlideTray™

Made of HIPS

The SlideTray™ is a convenient microscope slide holder made of heavy-duty plastic lasting many years even under the most adverse conditions. The SlideTray™ will hold up to 20 microscope slides in an almost horizontal position. Each slide can be easily removed and placed back in its position. The SlideTray™ is easily stackable and will take minimum space on any shelf or laboratory counter. Even when trays are stacked, slides are well protected and will not touch the tray above. Dimensions: 206 x 299 x 18 mm H (8<sup>1</sup>/<sub>8</sub> x 11<sup>3</sup>/<sub>4</sub> x 11<sup>11</sup>/<sub>16</sub> in. H)



Slides are easily inserted and removed.



Cat. #	Color	Qty/Cs
M755-20W	White	10

# CytoSep™ Family



The Simport® CytoSep™ Family is a series of Cytology Funnel sample chambers specially designed to concentrate cells into thin-layer preparations. Simport® is one of the most trusted names in the disposable plasticware marketplace, providing quality products since 1975 and is proud to offer the largest choice of Cytology Funnels on the market by manufacturing numerous models for use with the Shandon Cytospin® 4 Cyto centrifuge, the Sakura Cyto-Tek® Cyto centrifuge, the Hettich Cyto-System, the Unitech (Wescor) Cytopro® Cyto centrifuge and finally the StatSpin Cytofuge® 2 Cyto centrifuge. They are safer than reusable sample chambers and lower your risk of contamination to pathogenic samples. After use, they are simply discarded. The CytoSep™ Cytology Funnels are a time saver compared to cleaning and sterilizing reusable sample chambers. The Simport® CytoSep™ Cytology Funnels are recommended for the following applications:

- Bronchial alveolar lavage washes
- Cerebrospinal fluids
- Exudates and transudates
- Fine needle aspirates, and other aspirates
- Gastric washes
- Oral cavity washes
- Pericardial fluids
- Peritoneal fluids
- Pleural fluids
- Sputum
- Synovial fluids
- Urine

For IVD use 

## Consumables for the Shandon CytoSpin® Cytocentrifuges Single CytoSep™ Cytology Funnel



M964-10FW



M964-10FT



Fully compatible with the Shandon CytoSpin® Centrifuge, Simport® CytoSep™ Cytology Funnels can be used to deposit a thin layer of cells in a clearly defined area of a microscope slide. The filter card absorbs any excess fluid. These Cytology Funnels have the filter cards pre-attached for consistent, reliable results. No alignment necessary! All disposable Funnels are packaged with closure caps to seal in specimen for added protection. All components also available separately.

For sample volumes of up to 0.5 ml, use the Simport® Single CytoSep™ Cytology Funnel with a White Filter Card and Cap. It provides a cell deposition area of 6 mm (28 mm squared). Can be use with all stainless steel slide clips.

For samples volumes of up to 0.4 ml, such as Spinal Fluids for example, use the Single CytoSep™ Cytology Funnel with Brown Filter Card and Cap. It allows for a slower absorption of fluids. All the individual components are also available separately.

**Now available!  
Individually wrapped**

**For IVD use**

Cat. #	Description	Qty/Pk	Qty/Cs
M964-10FW	Single Funnel with White Filter & Cap	50	500
M964-10FW1	<b>Individually wrapped</b> Single Funnel with White Filter & Cap	100	500
M964-10FT	Single Funnel with Tan Filter & Cap	50	500
M964-1	Single Funnel only	–	500
M965C	Cap only	50	500
M965FW	White Filter Paper for Single Funnel	200	–
M965FT	Tan Filter Paper for Single Funnel	200	–

## Double CytoSep™ Cytology Funnel



M964-20FW



The Simport® Double CytoSep™ Cytology Funnel with disposable sample chamber allows for two samples to be run simultaneously on a single slide and is ideal for immunohistochemistry work. The Double CytoSep™ Cytology Funnel provides a cell deposition area of 6 mm (28 mm square) for sample volumes of up to 0.5 ml. The filter card comes pre-attached. Cap is included. Can be use with all stainless steel slide clips. Each component is also available separately.

**Now available!  
Individually wrapped**

**For IVD use**

Cat. #	Description	Qty/Pk	Qty/Cs
M964-20FW	Double Funnel with White Filter & Cap	50	500
M964-20FW1	<b>Individually wrapped</b> Double Funnel with White Filter & Cap	100	500
M964-1D	Double Funnel only	–	500
M965C	Cap only	50	500
M965FWD	White Filter Paper for Double Funnel	200	–

## Consumables for the Shandon Cytospin® Cytocentrifuges

ALL PLASTIC Single and Double CytoSep™ Cytology Funnels



These are so easy to use, and improve turn-around time while giving more diagnostic information. Being totally disposable, they eliminate time-consuming decontamination and cleaning. They are safe to use and reduce the risk of exposure to pathogenic samples. They also decrease the possibility of cross-contamination.

This series of Simport® Single CytoSep™ Cytology Funnels is single-use. The disposable sample chambers do not need metal clips and are designed to meet any processing requirement. They are capable of producing high quality thin-layer slide preparations while improving laboratory efficiency.

The disposable Sample Chambers with White Filter Cards are used for sample volumes up to 0.5 ml; the ones with the Brown Filter Cards are for sample volumes up to 0.4 ml. The cell deposition area is 6 mm in diameter (28 mm squared). Filter cards are pre-attached. Excellent for scanty specimens such as CSF. All components also available separately.

This CytoSep™ Cytology Funnel allows two sample deposition areas on a single slide. The disposable sample chambers do not need metal clips. inserted filter card. This Sample Chamber is also disposable.

Cat. #	Description	Qty/Pk	Qty/Cs
M965-10FW	Single Funnel with White Filter & Cap	40	480
M965-10FT	Single Funnel with Tan Filter & Cap	40	480
M965-20FW	Double Funnel with White Filter & Cap	40	480

For IVD use



**YOU CAN ALSO REUSE OR ACQUIRE ANY INDIVIDUAL COMPONENTS WHEN NEEDED**



Cat. #	Description	Qty/Pk	Qty/Cs
M965-1	Single Funnel only	50	500
M965-1D	Double Funnel only	50	500
M965B	Base only	50	500
M965C	Cap only	50	500
M965FW	White Filter Paper for Single Funnel	200	–
M965FT	Tan Filter Paper for Single Funnel	200	–
M965FWD	White Filter Paper for Double Funnel	200	–

Each component is strong enough to be reused.

For IVD use



Insert funnel into base.



Insert microscope slide.



Place new filter onto microscope slide.



Clip top of funnel and base together.



Your CytoSep ALL PLASTIC Cytofunnel is now ready to use.



## Consumables for the Shandon Cytospin® Cytocentrifuges

### MEGA CytoSep™ Cytology Funnel



The Simport® ALL PLASTIC CytoSep™ MEGA Funnel provides an easy, efficient and cost effective method of producing high quality thin-layer slide preparations. It eliminates the need for stainless steel slide clips, offering laboratory workflow improvements. It is dedicated for convenient preparation of larger volume samples.

This larger funnel is quick and easy to remove. The large rectangular cell deposition area of 22 x 14.75 mm (325 mm square) provides for up to 12 times the sample volume (6 ml) of the single CytoSep™ Cytology Funnel. It produces more cost-effective thin layer preparations when compared to other thin layer methods. Strategically placed baffles inhibit cell settling which results in uniform cell deposition and excellent quality slide preparations. Simport® ALL PLASTIC CytoSep™ Cytology MEGA Funnel and Cap minimize user exposure to pathogens while reducing the risk of specimen cross-contamination. Can prepare both air-dried and fixed preparations.

	Cat. #	Description	Qty/Pk	Qty/Cs
<b>For IVD use</b>	M965-40	MEGA Funnel & Cap	40	480



Filter Card for  
Shandon  
Reusable TPX  
Single Sample  
Chamber

Cat. #	Description	Qty/Pk	Qty/Cs
M965FWDV	White Filter Paper for TPX Cytology Funnel	200	–

## Consumables for the Sakura Cyto-Tek® Cytocentrifuge

### CytoSep™ Cytology Funnel for Sakura Cyto-Tek® Cytocentrifuge



All components are available separately. The Simport® CytoSep™ Cytology Funnel offers the 1 ml fluid chamber, the base holder, the chamber cap, and the filter paper.

	Cat. #	Description	Qty/Pk	Qty/Cs
	M963-1	Fluid Chamber only, 1 ml	50	200
	M963B	Base Holder only	50	200
	M963C	Cap only	50	200
<b>For IVD use</b>	M963FW	White Filter Card only	–	200

## Consumables for the Unitech (Wescor) Cyto-System

### Single CytoSep™ Cytology Funnels for the Unitech (Wescor) Cytopro® Cyto-centrifuge



These funnels will snap quickly in place, allowing the pad to align correctly with the sample tunnel. Made with a compression ring around the sample hole in order to better control the rate of absorption and to ensure more consistent results.

Two ports, one in the sample well and one in the tunnel, provide great versatility. Samples are loaded directly through the chamber caps to prevent spilling of hazardous ones. Caps provide added safety to the operator. A large, centered cell deposit area makes screening easier and more sensitive.

	Cat. #	Description	Qty/Pk	Qty/Cs
For IVD use	M967-10FW	Single Sample Chamber With White Filter Paper & Cap	48	–
	M967FW	White Filter Paper for Single Funnel	–	100

### Dual CytoSep™ Cytology Funnels for the Unitech (Wescor) Cytopro® Cyto-centrifuge



With two chambers, cell deposit areas are close together and easy to find, helping to speed sample analysis. Two deposit areas on one slide enhance all of the advantages of the popular single chambers. Reduced time spent loading and unloading slides.

- Two cell deposit areas on the same slide means true cost reduction.
- Two deposit areas on one slide enhance productivity for those under regulatory workload limitations.
- Reduced time spent loading and unloading slides between the rotor, stainer and microscope.
- Cell deposit areas are close together and easy to find, helping to speed sample analysis.
- Cytopro's 7 mm diameter spot provides a 37% larger area to collect cells.

	Cat. #	Description	Qty/Pk	Qty/Cs
For IVD use	M967-20FW	Double Sample Chamber With White Filter Paper & Cap	48	–
	M967FWD	White Filter Paper for Double Funnel	–	100

## Consumables for the StatSpin Cytofuge® 2 Cytocentrifuge

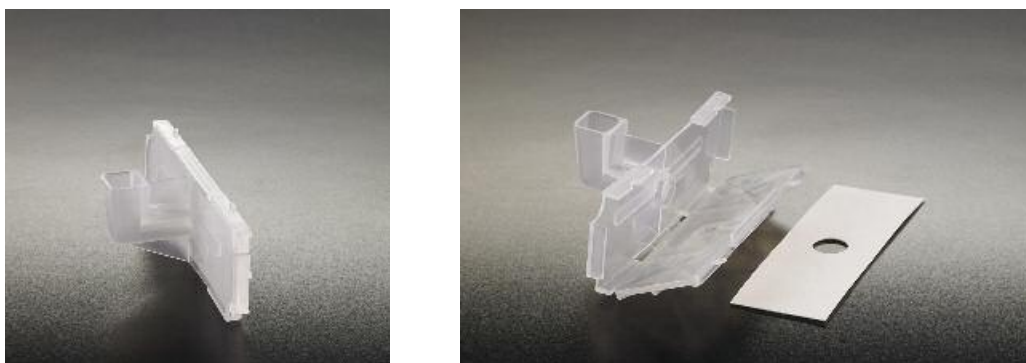

Simport® CytoSep™ Cytology Funnels for the StatSpin Cytofuge® 2 Cytocentrifuge allow cells to gently concentrate in a 7 mm diameter area on the slide while supernatant is simultaneously absorbed by a filter card. Will accept 50-400 µl of sample. Produces cell monolayer presentations of excellent quality. Disposable filter sold separately.

Cat. #	Description	Qty/Pk
M968-1	Cell Concentrator	48
M968FW	Disposable Filter Concentrator	200

For IVD use

## Consumables for the Hettich Cyto-System



The Simport® CytoSep™ Funnel Chambers for the Hettich Cyto-System optimize lab throughput with multiple funnel options in 2, 3, or 4 funnels per slide. These funnels are perfect for every application such as CSF, Viral infections, bronchial secretions and come in four sizes from 1 ml to 8 ml. The 1 ml chamber is for small-volume samples of low cell contents. Both 2 and 4 ml chambers are suggested for cell-rich samples, e.g. pleura, ascites and bronchial washings while the 8 ml chamber is perfect for large-volume samples such as urine.

Cat. #	Description	Qty/Pk	Qty/Cs
M966-1	One-Funnel Chamber, 1 ml	10	50
M966-2	One-Funnel Chamber, 2 ml	10	50
M966-4	One-Funnel Chamber, 4 ml	10	50
M966-8	One-Funnel Chamber, 8 ml	10	50
M966FW	Filter for 1, 2 and 4 ml Chambers	200	–
M966FW8	Filter for the 8 ml Chamber	200	–

For IVD use



## P200

### DROPETTE® Disposable Transfer Pipets

Made of low density polyethylene

These all-in-one pipets eliminate the hazard of broken glass and exposure to infectious materials. Put an end to matching rubber bulbs with glass pipets. Molded from see-through low density polyethylene. Inert to biological fluids and most acids. The low-affinity surface reduces the loss of cells and valuable proteins due to binding. Can be sealed and refrigerated. They work well whenever there is a need for quick, safe transfer of fluids. Temperature resistant down to -196 °C. Can be gaz (EtO) sterilized. Choose between 12 very popular models, available in several sizes, tip designs and lengths, in sterile or non sterile packaging. Seven models provide graduations.



- Will not shatter
- Can be used in liquid nitrogen
- Non toxic and inert
- No bulb to insert or remove
- Uniform drop size

Cat. #	Sterile	Graduated	Length	Capacity	Bulb draw	Inner pack
P200-10 P200-101S* P200-1020S*	• •		6.3 cm	1.2 ml	0.9 ml	Loose 1 20
P200-14 P200-141S* P200-1420S*	• •	•	11.4 cm	1.5 ml	0.8 ml	Loose 1 20
P200-20 P200-201S* P200-2020S*	• •		8.7 cm	1.7 ml	0.9 ml	Loose 1 20
P200-30 P200-301S* P200-3020S*	• •	•	13.8 cm	3 ml	2.1 ml	Loose 1 20
P200-44 P200-441S* P200-445S* P200-4410S* P200-4420S*	• • • • •		15.5 cm	4 ml	3.1 ml	Loose 1 5 10 20
P200-52 P200-521S* P200-525S* P200-5210S* P200-5220S*	• • • • •	•	15 cm	5 ml	3.1 ml	Loose 1 5 10 20
P200-56 P200-561S* P200-565S* P200-5610S* P200-5620S*	• • • • •	•	15.5 cm	5 ml	1.9 ml	Loose 1 5 10 20
P200-58 P200-581S* P200-5820S*	• •	•	15.6 cm	5 ml	1.8 ml	Loose 1 20
P200-58V P200-58V1S* P200-58V20S*	• •	•	14.5 cm	5 ml	1.8 ml	Loose 1 20
P200-60 P200-601S* P200-605S* P200-6010S* P200-6020S*	• • • • •		22.5 cm	6 ml	2.3 ml	Loose 1 5 10 20
P200-72 P200-721S* P200-725S* P200-7210S* P200-7220S*	• • • • •	•	15.5 cm	7 ml	3.2 ml	Loose 1 5 10 20
P200-82 P200-821S* P200-8220S*	• •		15 cm	8 ml	4.6 ml	Loose 1 20

## Packaging:

All non sterile pipets are in boxes of 500 and cases of 5000.

Exception: P200-82 are in boxes of 400 and cases of 4000.

Most sterile pipets are in boxes of 400 and cases of 4000.

*\* Available on request only. Minimum quantities apply. Please enquire for more details.*



## ChillBlock™

### Tube Rack Collection

ChillBlock™ thermo-conductive metal alloy tube racks eliminate inconsistencies which occur due to inserting tubes directly into ice, dry ice, alcohol baths, water baths and other common laboratory temperature sources. Place the ChillBlock™ tube rack directly onto a temperature source and it will rapidly adapt to that temperature from -150°C to >+100°C. ChillBlock™ tube racks ensure +/- 0.1°C temperature uniformity of all tubes when cooling, freezing or heating. ChillBlock™ tube racks are available in a variety of sizes for tubes such as microcentrifuge tubes, cryogenic vials, PCR tubes, SBS-compliant strips and plates and 15 mL and 50 mL tubes.



### Anatomy of a ChillBlock™

Individual wells minimize risks of tube contamination by water or ice.

Can be autoclaved or cleaned with disinfectants.

Anodized surface resistant to rust, corrosion and abrasion.

Temperature uniformity through the whole ChillBlock™ rack.

Tubes stay upright and are easier to manipulate.

Alphanumeric identification of wells facilitating tube location.



### APPLICATIONS

#### Use on Ice

- Adapts from ambient to <4°C in 60-90 seconds
- Samples and labels stay dry, organized and uniform in temperature
- Hours of ice cooling without direct ice contact

#### Use on Dry Ice

- Adapts from ambient to -78°C in 5-7 minutes
- Eliminates ethanol – cost savings, no hazardous waste
- Equal or better freezing rate when compared to other methods

#### Use above Liquid Nitrogen

- Adapts from ambient to -140°C in 15 minutes
- Samples are upright and organized as they freeze
- No direct contact between samples and liquid nitrogen

#### Heating methods

Use ChillBlock™ tube racks with heat sources such as:

- waterbath
- incubator
- hot plate, oven

# THERMAL CONDUCTIVE RACKS

## S700-1, -4, -6, -8, -10

### ChillBlock™ Microcentrifuge Tube Racks

ChillBlock™ Microcentrifuge Tube Racks are available in five models from 6 to 96 wells. An alphanumeric grid allows for indexing rows and columns, therefore facilitating tube location. These racks will hold 1.5 ml and 2.0 ml snap cap Microcentrifuge tubes. They will also accommodate the popular 0.5 ml to 2.0 ml screw cap Microcentrifuge tubes such as the Simport Micrewtube® Series.



Cat. No	Wells	Dimensions (L x W x H)	Qty/Cs
S700-1	6	2.4 x 1.7 x 1.5 in / 6.0 x 4.3 x 3.2 cm	1
S700-4	15	3.8 x 2.4 x 1.5 in / 9.6 x 6.0 x 3.2 cm	1
S700-6	30	4.5 x 3.8 x 1.5 in / 11.4 x 9.6 x 3.2 cm	1
S700-8	90	10.8 x 4.5 x 1.5 in / 27.4 x 11.4 x 3.2 cm	1
S700-10	96	8.7 x 5.9 x 1.5 in / 22.1 x 14.9 x 3.2 cm	1



This group of racks will also accommodate the popular 0.5 ml to 2.0 ml screw cap Microcentrifuge tubes such as the Simport Micrewtube® Series.



These wells have a vertical wall in order to accommodate all types of Microcentrifuge tubes up to 2 ml.



Alphanumeric identification of wells facilitating tube location.

## In your ChillBlock™ racks, have you ever considered using Simport® Microcentrifuge tubes?

### The Micrewtube® Family Screw Cap Microcentrifuge Tubes

T332 – T361 Series

A Simport MICREWUBE® has a multitude of applications around your lab. It is ideal for freezer storage, boiling application, centrifugation etc. and will fit most standard microcentrifuge rotors. Six styles of caps to choose from, and three sizes of conical bottom or self-standing tubes (0.5 ml, 1.5 ml and 2 ml).

A TUBE FOR EVERY APPLICATION



### Clicklok™ Microcentrifuge Tube Family



T330 & T331 Series

- Extra clarity for better visual inspection
- Boil-proof design
- Ultra rugged walls made for high speed centrifugation
- Unique ClickLok™ sealing mechanism
- Made of highest purity polypropylene.

# THERMAL CONDUCTIVE RACKS

## S700-14, -16, -18

### ChillBlock™ Profile Fit Microcentrifuge Tube Racks

S700-16 and S700-18 ChillBlock™ Profile Fit Microcentrifuge Tube Racks are available with either 15 & 30 wells holding 1.5 ml snap cap Microcentrifuge tubes. S700-14 is a 30-well rack and will hold 0.5 ml tubes. An alphanumeric grid allows for indexing rows and columns, therefore facilitating tube location. Each cavity will ensure a more efficient thermal exchange since it is in direct contact with the entire tube wall.

Cat. #	Wells	Dimensions (L x W x H)	Qty/Cs
S700-14	30	4.5 x 3.8 x 1.5 in / 11.4 x 9.6 x 3.2 cm	1
S700-16	15	3.8 x 2.4 x 1.5 in / 9.6 x 6.0 x 3.2 cm	1
S700-18	30	4.5 x 3.8 x 1.5 in / 11.4 x 9.6 x 3.2 cm	1



Excellent temperature exchange since tube wall is in direct contact with rack.



Alphanumeric identification of wells facilitating tube location.

## In your ChillBlock™ racks, have you ever considered using Simport® Microcentrifuge tubes?

### Cliklok™ Microcentrifuge Tube Family



#### T330 & T331 Series

- Extra clarity for better visual inspection
- Boil-proof design
- Ultra rugged walls made for high speed centrifugation
- Unique ClickLok™ sealing mechanism
- Made of highest purity polypropylene.



## S700-24, -28

### ChillBlock™ Cluster or Storage Tube Racks

The ChillBlock™ Cluster Tube Racks are available in two models of 96 wells each. An alphanumeric grid allows for indexing rows and columns, therefore facilitating tube position. S700-24 rack will hold 0.5 ml cluster tubes while S700-28 rack accepts 1.2 or 1.4 ml cluster tubes.

Cat. #	Wells	Dimensions (L x W x H)	Qty/Cs
S700-24	96	5 x 3.4 x 1.5 in / 12.8 x 8.5 x 3.2 cm	1
S700-28	96	5 x 3.4 x 1.7 in / 12.8 x 8.5 x 4.3 cm	1

## In your ChillBlock™ racks, have you ever considered using Simport® Cluster tubes?

### Cluster Tubes T100 Series

Tubes are made of autoclavable polypropylene and are available either individually or in strips of 8 or 12 detachable tubes. Tubes have a gross volume of 1.2 ml but with a cap in place, they will hold 1.1 ml. Caps are made of polyethylene and are not autoclavable. They are available individually and also in strips of 8 or 12.

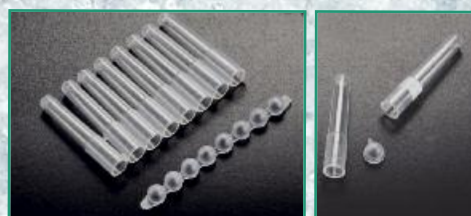



# THERMAL CONDUCTIVE RACKS

## S700-35, -40

### ChillBlock™ 15 ml and 50 ml Centrifuge Tube Racks

The ChillBlock™ 15 ml and 50 ml Centrifuge Tube Racks are available in two configurations, one of 9 wells for 15 ml centrifuge tubes and one of 4 wells for 50 ml centrifuge tubes. An alphanumeric grid allows for indexing rows and columns, therefore facilitating tube location.

Cat. #	Wells	For tubes	Dimensions (L x W x H)	Qty/Cs
S700-35	9	15 ml	3.1 x 3.1 x 4.2 in / 7.9 x 7.9 x 10.7 cm	1
S700-40	4	50 ml	3.5 x 3.5 x 4.4 in / 8.9 x 8.9 x 11.2 cm	1



Alphanumeric identification of wells facilitating tube location.

## In your ChillBlock™ racks, have you ever considered using Simport® Centrifuge tubes?

### 15 ml Centrifuge Tubes - T408



Suitable for general centrifugation, urinalysis procedures and serum separation. These conical bottom tubes are chemically clean and metal free, ready to use and uniform in size and shape.

### 50 ml Centrifuge Tubes - T420



These centrifuge tubes are useful for collecting and transporting biological specimens. Leakproof characteristics are ensured by a flat top plastic screw cap with an inner sealing lip. Tubes are made of translucent polypropylene or optically clear polystyrene with molded graduations from 2.5 to 50 ml.



## S700-50, -52, -56, -58

ChillBlock™

### SBS Footprint Tube Racks



These ChillBlock™ SBS Footprint Tube Racks conform in size to the SBS standard footprint and are compatible for quick transfer to automated systems. An alphanumeric grid allows for indexing rows and columns, therefore facilitating tube location. Depending on the model, they will accept 200 µL PCR tubes, strips, plates and most Microcentrifuge tubes. S700-56 Rack will hold twelve screw cap Microcentrifuge tubes or 1.5 ml and 2.0 ml snap cap Microcentrifuge tubes along with up to 6 PCR strips or 48 individual 0.2 ml PCR tubes.

Cat. #	Wells	Dimensions (L x W x H)	Qty/Cs
S700-50	96	5 x 3.4 x 1 in / 12.8 x 8.5 x 2.5 cm	1
S700-52	384	5 x 3.4 x 0.8 in / 12.8 x 8.5 x 2.3 cm	1
S700-56	60	5 x 3.4 x 1.5 in / 12.8 x 8.5 x 3.2 cm	1
S700-58	24	5 x 3.4 x 1.5 in / 12.8 x 8.5 x 3.2 cm	1



Rack S700-56 will hold twelve 1.5 and 2.0 ml Microcentrifuge tubes and 0.2 ml PCR tubes or strips.



Rack S700-58 will hold up to 24 x 1.5 or 2.0ml Microcentrifuge tubes.



Alphanumeric identification of wells facilitating tube location.

# THERMAL CONDUCTIVE RACKS

## S700-60, -80, -82, -84

### ChillBlock™ Cryogenic Vial Tube Racks

ChillBlock™ Cryogenic Vial Racks are specially designed for Cryogenic vials and are available in four models with 15 to 45 wells. An alphanumeric grid allows for indexing rows and columns, therefore facilitating tube location. These racks will hold 1.0 ml to 2.0 ml inner and outer threaded Cryogenic vials. They will also accommodate the Simport® similar sample tubes (T500 and T501 Series). Rack S700-60 has a universal locking base, allowing most cryogenic vials and sample tubes up to 5 ml to lock in place and facilitate screw cap removal using only one hand.



Alphanumeric identification of wells facilitating tube location

Cat. #	Wells	Dimensions (L x W x H)	Qty/Cs
S700-60	24	5 x 3.4 x 1.5 in / 12.8 x 8.5 x 3.2 cm	1
S700-80	15	3.8 x 2.4 x 1.5 in / 9.6 x 6 x 3.2 cm	1
S700-82	30	4.5 x 3.8 x 1.5 in / 11.4 x 9.6 x 3.2 cm	1
S700-84	45	6.8 x 3.8 x 1.5 in / 17.3 x 9.6 x 3.2 cm	1

## In your ChillBlock™ racks, have you ever considered using Simport® Cryovial and Sample tubes?

### Cryovial - Series T301, T308, T309, T310, T311



The Simport® Cryovial® Family is the most complete line of cryogenic vials available today. Designed for storing cells, blood, serum and other biological fluids at temperatures as low as -196 °C, these sturdy polypropylene vials offer a high level of chemical resistance.

### Sample Tubes - Series T501



Designed for the storage and transportation of biological material. Manufactured from non-toxic polypropylene, the tube provides strength and clarity and exhibits some unique design features. The vial has external threads, providing a smooth and uniform inner surface, thus reducing the risk of contamination.



## S700-90, -92

### ChillBlock™ Platforms



These two thermo-conductive platforms can be placed in ice, dry ice, liquid nitrogen or even in a water bath. They will keep ChillBlock™ racks at the proper temperature which will remain completely dry while on the platform. The thermo-conductive properties of the ChillBlock™ platforms ensure uniform temperature distribution throughout. **Not available for sale in the USA.**

Cat. #	Dimensions (L x W x H)	Qty/Cs
S700-90	11 x 5.5 x 3.4 in / 27.9 x 14 x 8.6 cm	1
S700-92	11 x 5.5 x 2.5 in / 27.9 x 14 x 6.3 cm	1



By using these platforms, even the ChillBlock™ racks remain completely dry.

## ChillBlock™ Plastic Racks

S700-475, -476, -477

## ChillBlock™ Microcentrifuge Tube Plastic Racks

Made of polycarbonate

An alternative to ice buckets for keeping reagents and enzymes cool. Great for a multitude of tubes such as Microcentrifuge tubes with snap cap or screw cap (in all three racks) along with 1.2 and 2.0 ml Simport® sample tubes (in rack S700-476). Also protects critical samples from temperature fluctuations in the freezers. Base is filled with non-toxic gel. Will maintain temperature for approximately 1 hour on the bench. Freeze for 24 hrs at -20°C to -25°C before use.

Cat. #	Wells	Dimensions (L x W x H)	Qty/Cs
S700-475	12	5.7 x 4.0 x 3.9 in / 15.5 x 10.1 x 9.8 cm	1
S700-476	20	8.25 x 6.4 x 4.4 in / 20.9 x 16.3 x 11.1 cm	1
S700-477	32	8.9 x 5.0 x 3.8 in / 22.7 x 12.8 x 9.6 cm	1



All Simport® tubes in the Microw Family will also fit in these three racks.



## S700-480

## ChillBlock™ Microcentrifuge Tube Plastic Rack

Made of polycarbonate

Base and cover are filled with non-toxic gel. Will maintain temperature for approximately 2 hours on the bench. Alphanumeric grid for easy identification of tubes. Also protects critical samples from temperature fluctuations in the freezers. Freeze for 24 hrs at -20°C to -25°C before use.

Cat. #	Wells	Dimensions (L x W x H)	Qty/Cs
S700-480	32	8.9 x 5.0 x 4.4 in / 22.7 x 12.8 x 11.1 cm	1

## S700-490

## ChillBlock™ PCR Plate & Strip Plastic Rack

Made of polycarbonate

This cooler is designed to protect enzymes & solutions by maintaining them at temperatures between -20°C and -15°C up to 2 hours during sample preparations on the bench. Base is filled with non-toxic gel. The aluminium block has 96 wells to hold tubes, strips or plates. Freeze for 24 hrs at -20°C to -25°C before use.

Cat. #	Wells	Dimensions (L x W x H)	Qty/Cs
S700-490	96	8.25 x 3.8 x 1.5 in / 17.3 x 9.6 x 3.2 cm	1



## S700-600

## ChillBlock™ Cryogenic Vial Cooler













Made of polycarbonate – Cover made of HDPE

Used for cell cryopreservation and recovery, this cooler gives -1°C/min cooling rate for up to 18 cryovials of 1 to 2 ml. The cooler needs 250 ml of 100% isopropyl alcohol and should be placed in a mechanical freezer. Screw top 120mm lid secures samples inside container. Vials never come in contact with the alcohol.















Cat. #	Wells	Dimensions (L x W x H)	Qty/Cs
S700-600	18	6.8 x 3.8 x 1.5 in / 17.3 x 9.6 x 3.2 cm	1



## ChillBlock™ Selection Chart

	Item No.	For Use With	Wells	Well Shape	Well Diameter	Well Depth	Dimensions (L x W x H)	Row Spacing	Column Spacing	Weight
	S700-1	1.5 ml and 2.0 ml Microcentrifuge Tubes	6	Cylindrical	0.43 in / 11.1 mm	1.28 in / 32.6 mm	2.4 x 1.7 x 1.5 in 6.0 x 4.3 x 3.2 cm	0.7 in / 17.8 mm	0.7 in / 17.8 mm	194 gr / 0.43 lb
	S700-4	1.5 ml and 2.0 ml Microcentrifuge Tubes	15	Cylindrical	0.43 in / 11.1 mm	1.28 in / 32.6 mm	3.8 x 2.4 x 1.5 in 9.6 x 6.0 x 3.2 cm	0.7 in / 17.8 mm	0.7 in / 17.8 mm	450 gr / 0.99 lb
	S700-6	1.5 ml and 2.0 ml Microcentrifuge Tubes	30	Cylindrical	0.43 in / 11.1 mm	1.28 in / 32.6 mm	4.5 x 3.8 x 1.5 in 11.4 x 9.6 x 3.2 cm	0.7 in / 17.8 mm	0.7 in / 17.8 mm	854 gr / 1.88 lb
	S700-8	1.5 ml and 2.0 ml Microcentrifuge Tubes	90	Cylindrical	0.43 in / 11.1 mm	1.28 in / 32.6 mm	10.8 x 4.5 x 1.5 in 27.4 x 11.4 x 3.2 cm	0.7 in / 17.8 mm	0.7 in / 17.8 mm	2428 gr / 5.35 lb
	S700-10	1.5 ml and 2.0 ml Microcentrifuge Tubes	90	Cylindrical	0.43 in / 11.1 mm	1.28 in / 32.6 mm	18.7 x 5.9 x 1.5 in 22.1 x 14.9 x 3.2 cm	0.7 in / 17.8 mm	0.7 in / 17.8 mm	2582 gr / 5.69 lb
	S700-14	500 µl Conical Microcentrifuge Tubes	30	Conical	0.33 in / 8.4 mm	1.17 in / 29.6 mm	4.5 x 3.8 x 1.5 in 11.4 x 9.6 x 3.2 cm	0.7 in / 17.8 mm	0.7 in / 17.8 mm	1010 gr / 2.23 lb
	S700-16	1.5 ml Conical Microcentrifuge Tubes	15	Conical	0.43 in / 11.1 mm	1.38 in / 35.1 mm	3.8 x 2.4 x 1.5 in 9.6 x 6.0 x 3.2 cm	0.7 in / 17.8 mm	0.7 in / 17.8 mm	468 gr / 1.03 lb
	S700-18	1.5 ml Conical Microcentrifuge Tubes	30	Conical	0.43 in / 11.1 mm	1.38 in / 35.1 mm	4.5 x 3.8 x 1.5 in 11.4 x 9.6 x 3.2 cm	0.7 in / 17.8 mm	0.7 in / 17.8 mm	884 gr / 1.95 lb
	S700-24	0.5 ml Cluster Tubes	96	Cylindrical	0.33 in / 8.4 mm	0.63 in / 15.9 mm	5.0 x 3.4 x 1.5 in 12.8 x 8.5 x 3.2 cm	0.35 in / 9.0 mm	0.35 in / 9.0 mm	424 gr / 0.93 lb
	S700-28	1.4 ml Cluster Tubes	96	Cylindrical	0.33 in / 8.4 mm	1.26 in / 32.1 mm	5.0 x 3.4 x 1.7 in 12.8 x 8.5 x 4.3 cm	0.35 in / 9.0 mm	0.35 in / 9.0 mm	614 gr / 1.35 lb
	S700-35	15 ml Centrifuge Tubes	9	Cylindrical	0.67 in / 17.1 mm	4.2 in / 106.6 mm	3.1 x 3.1 x 4.2 in 7.9 x 7.9 x 10.7 cm	1.05 in / 26.7 mm	1.05 in / 26.7 mm	1218 gr / 2.68 lb
	S700-40	50 ml Centrifuge Tubes	4	Cylindrical	1.16 in / 29.5 mm	4.0 in / 101.6 mm	3.15 x 3.5 x 4.4 in 8.9 x 8.9 x 11.2 cm	1.05 in / 38.1 mm	1.05 in / 38.1 mm	1584 gr / 3.49 lb
	S700-50	96-well PCR Plates	96	Conical	0.27 in / 6.9 mm	0.79 in / 20.1 mm	5.0 x 3.4 x 1.0 in 12.8 x 8.5 x 2.5 cm	0.35 in / 9.0 mm	0.35 in / 9.0 mm	522 gr / 1.15 lb

# THERMAL CONDUCTIVE RACKS

	Item No.	For Use With	Wells	Well Shape	Well Diameter	Well Depth	Dimensions (L x W x H)	Row Spacing	Column Spacing	Weight
	S700-52	384-well PCR Plates	384	Conical	0.16 in / 4.1 mm	0.32 in / 8.1 mm	5.0 x 3.4 x 0.8 in 12.8 x 8.5 x 2.3 cm	0.18 in / 4.5 mm	0.18 in / 4.5 mm	462 gr / 1.02 lb
	S700-56	1.5 ml and 200 µl Tubes	60	Conical	0.25 in / 6.3 mm 0.43 in / 11.1 mm	0.63 in / 15.9 mm 1.38 in / 35.1 mm	5.0 x 3.4 x 1.5 in 12.8 x 8.5 x 3.2 cm	0.35 in / 9.0 mm 0.7 in / 17.8 mm	0.35 in / 9.0 mm 0.8 in / 20.3 mm	922 gr / 2.03 lb
	S700-58	1.5 ml Microcentrifuge Tubes	24	Conical	0.43 in / 11.1 mm	1.38 in / 35.1 mm	5.0 x 3.4 x 1.5 in 12.8 x 8.5 x 3.2 cm	0.7 in / 17.8 mm	0.8 in / 20.3 mm	894 gr / 1.97 lb
	S700-60	Cryogenic Vials	24	Conical	0.50 in / 12.7 mm	1.29 in / 32.7 mm	5.0 x 3.4 x 1.5 in 12.8 x 8.5 x 3.2 cm	0.76 in / 19.3 mm	0.76 in / 19.3 mm	820 gr / 1.50 lb
	S700-80	Cryogenic Vials	15	Cylindrical	0.50 in / 12.7 mm	1.28 in / 32.6 mm	3.8 x 2.4 x 1.5 in 9.6 x 6.0 x 3.2 cm	0.7 in / 17.8 mm	0.7 in / 17.8 mm	408 gr / 0.90 lb
	S700-82	Cryogenic Vials	30	Cylindrical	0.50 in / 12.7 mm	1.29 in / 32.7 mm	4.5 x 3.8 x 1.5 in 11.4 x 9.6 x 3.2 cm	0.7 in / 17.8 mm	0.7 in / 17.8 mm	776 gr / 1.71 lb
	S700-84	Cryogenic Vials	45	Cylindrical	0.50 in / 12.7 mm	1.29 in / 32.7 mm	6.8 x 3.8 x 1.5 in 17.3x 9.6 x 3.2 cm	0.7 in / 17.8 mm	0.7 in / 17.8 mm	1178 gr / 2.60 lb
	S700-90	ChillBlock Tube Racks	N/A	N/A	N/A	N/A	11.0 x 5.5 x 3.4 in 27.9 x 14.0 x 8.6 cm	N/A	N/A	1702 gr / 3.75 lb
	S700-92	ChillBlock Tube Racks	N/A	N/A	N/A	N/A	11.0 x 5.5 x 2.5 in 27.9 x 14.0 x 6.3 cm	N/A	N/A	1508 gr / 3.32 lb
	S700-475	ChillBlock 12 Wells, 1.5 ml Tubes	12	Conical	0.485 in / 12.3 mm	1.56 in / 39.7 mm	5.7 x 4.0 x 3.9 in 14.5 x 10.1 x 9.8 cm	0.84 in / 21.3 mm	0.84 in / 21.3 mm	620 gr / 1.36 lb
	S700-476	ChillBlock 20 Wells, 1.5 ml Tubes	20	Conical	0.490 in / 12.4 mm	1.82 in / 46.2 mm	8.25 x 6.4 x 4.4 in 20.9 x 16.3 x 11.1 cm	1.25 in / 31.7 mm	1.25 in / 31.7 mm	1962 gr / 4.32 lb
	S700-477	ChillBlock 1.5 ml Tubes	32	Conical	0.485 in / 12.3 mm	1.57 in / 40.0 mm	8.9 x 5.0 x 3.8 in 22.7x 12.8 x 9.6 cm	0.84 in / 21.3 mm	0.84 in / 21.3 mm	1350 gr / 2.97 lb
	S700-480	1.5 ml Tubes (with gel filled cover)	32	Cylindrical	0.485 in / 12.3 mm	1.57 in / 40.0 mm	8.9 x 5.0 x 4.4 in 22.7x 12.8 x 11.1 cm	0.84 in / 21.3 mm	0.84 in / 21.3 mm	1748 gr / 3.85 lb
	S700-490	0.2 ml PCR Tubes, Strip or Plates	96	Cylindrical	0.25 in / 6.3 mm	0.73 in / 18.4 cm	8.25 x 6.4 x 4.4 in 20.9 x 16.3 x 11.1 cm	0.35 in / 9.0 mm	0.35 in / 9.0 mm	1966 gr / 4.33 lb
	S700-600	ChillCooler for 1-2 ml Cryogenic Vials	18	Conical	0.6 in / 15.2 mm	1.24 in / 3.1 cm	04.9 x 3.4 in 012.5 x 8.6 ina	0.8 in / 20.3 mm	0.8 in / 20.3 mm	192 gr / 0.42 lb



# Biotube<sup>TM</sup> Collection

Simport® offers a wide choice of racks containing 96 x 1.2 ml tubes (8.8 mm top dia. x 45 mm H, or strips of 8 or 12. Tubes, strips, caps and boxes are available as separate units as well. The racks hold the tubes in the standard microtiter configuration of 8 x 12 and are available sterile or non sterile. The racks can be autoclaved up to 100 times. Both tubes and racks will resist most research chemicals. They can also be stored at temperatures as low as -90 °C and their configuration allows for optimum use of freezer space.

Each rack cover has an alphanumeric numbering system for identifying tubes and is supplied with a removable 96-place ID card for recording sample location. The transparent cover allows the user to see the contents of the rack and is keyed to the base to prevent misalignment.

## T100 BioTube™ Racks

Made of polypropylene

The T100 BIOTUBE™ rack with standard 96-well on center spacing of tubes offers a color coding system using colored interchangeable plastic grids. These are used as a support for the 1.2 ml tubes. This unique grid stands on four legs and can be removed from the base of the box and placed on a lab counter as a self-standing support. It can also be placed in a refrigerator or freezer shelf for improved air circulation around tubes, or in a water bath to allow controlled warming of the tubes and their contents. Easy to read numbers and letters used on the box cover for sample identification are also shown on the support grids. The gridded racks are available in a choice of four popular colors: blue, green, red and yellow. These racks and tubes are also ideal for storing, freezing and transporting reagents and specimens. For details on tubes and strips, see page 79.

Rack is made of 3 components:

- A white base
- A removable grid plate that can hold individual or strips of tubes
- A translucent cover



Cat. #	Description	Grid Plate Color	Qty/Cs
T100-1B	Rack with 96 plain individual tubes	Blue	10
T100-1G	Rack with 96 plain individual tubes	Green	10
T100-1R	Rack with 96 plain individual tubes	Red	10
T100-1Y	Rack with 96 plain individual tubes	Yellow	10

Cat. #	Description	Grid Plate Color	Qty/Cs
T100-2B	Rack with 96 plain individual tubes, sterile	Blue	10
T100-2G	Rack with 96 plain individual tubes, sterile	Green	10
T100-2R	Rack with 96 plain individual tubes, sterile	Red	10
T100-2Y	Rack with 96 plain individual tubes, sterile	Yellow	10

Cat. #	Description	Grid Plate Color	Qty/Cs
T100-3B	Rack with 12 strips of 8 tubes	Blue	10
T100-3G	Rack with 12 strips of 8 tubes	Green	10
T100-3R	Rack with 12 strips of 8 tubes	Red	10
T100-3Y	Rack with 12 strips of 8 tubes	Yellow	10

Cat. #	Description	Grid Plate Color	Qty/Cs
T100-4B	Rack with 12 strips of 8 tubes, sterile	Blue	10
T100-4G	Rack with 12 strips of 8 tubes, sterile	Green	10
T100-4R	Rack with 12 strips of 8 tubes, sterile	Red	10
T100-4Y	Rack with 12 strips of 8 tubes, sterile	Yellow	10

Cat. #	Description	Grid Plate Color	Qty/Cs
T100-50B	Storage box only	Blue	10
T100-50G	Storage box only	Green	10
T100-50R	Storage box only	Red	10
T100-50Y	Storage box only	Yellow	10

Cat. #	Description	Grid Plate Color	Qty/Cs
T100-60B	Grid Plate only	Blue	10
T100-60G	Grid Plate only	Green	10
T100-60R	Grid Plate only	Red	10
T100-60Y	Grid Plate only	Yellow	10

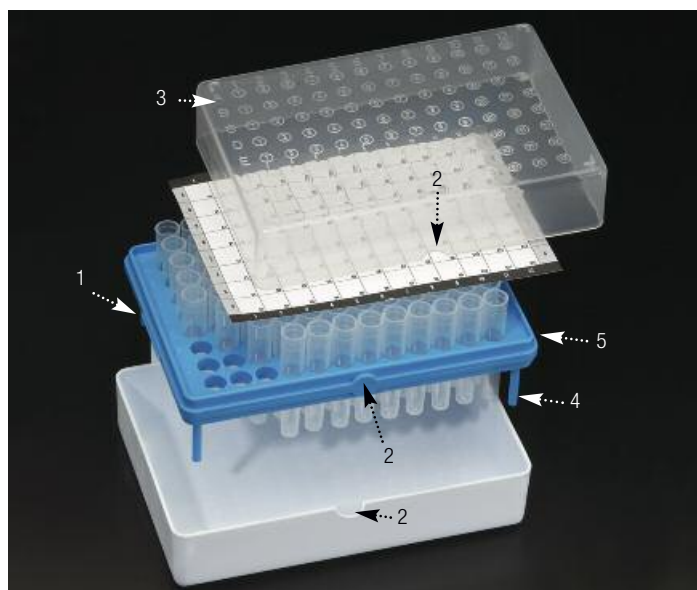

- 1- Convenient carrying handles on both sides
- 2- Cover, grid plate and base are keyed to prevent misalignment
- 3- Easy to read ID numbers and letters
- 4- Grid plate stands on 4 legs and can be placed on a lab counter, in a water bath
- 5- These racks and tubes are also ideal for storing, freezing and transporting reagents and specimens

Products on this page are certified RNase, DNase, Pyrogen and DNA-free.

# CLUSTER TUBES

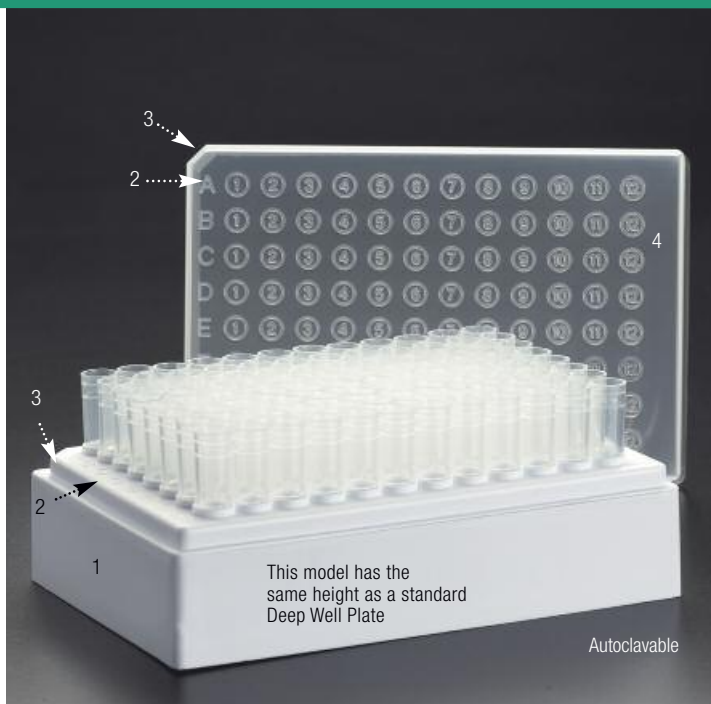

This model has the same height as a standard Deep Well Plate

Autoclavable

1. This rack has a standard microtiter sized footprint.
2. Easy to read ID numbers and letters
3. Cover and base are keyed to prevent misalignment
4. Translucent cover



T101-50

## T101 BioTube™ Rack



Made of polypropylene

The T101 BIOTUBE™ System is designed in such a way that the 96-place rack, having a standard on-center spacing of tubes, also has a standard microtiter sized footprint. This rack is therefore suitable for use with robotics systems and for transferring liquids with multichannel pipettors and autosampling devices that conform to 96-well microplate systems. The same alphanumeric identification is used on the cover and white base. Autoclavable.

These racks are ideal for HTLV-III testing, bacterial and hybridoma cell uptake studies, cell harvesting, pharmaceutical quality control, receptor binding assays, RIA and EIA.

Cat. #	Description	Qty/Cs
T101-1	Rack with 96 plain individual tubes, non sterile	10
T101-2	Rack with 96 plain individual tubes, sterile	10
T101-3	Rack with 12 strips of 8 tubes, non sterile	10
T101-4	Rack with 12 strips of 8 tubes, sterile	10
T101-5	Rack with 8 strips of 12 tubes, non sterile	10
T101-6	Rack with 8 strips of 12 tubes, sterile	10
Cat. #	Description	Qty/Cs
T101-50	Storage Box only	10

For details on tubes and strips, see page 79.



## T105 BioTube™ Storage Rack with 2 ml Tubes



Made of polypropylene

Compatible with most robotic workstations, this polypropylene storage rack can be used with most cell harvesters and leading 8- & 12-channel pipettors.

It contains 96 removable polypropylene square tubes in a 8 x 12 configuration, each having a 2.1 ml capacity (2 ml when capped). Although the tubes are square, the bottom is round to facilitate emptying. For procedures requiring a low surface tension such as protein and nucleic acid work, Simport® has developed a special tube (cat.# T105-20LST) using a type of polypropylene specifically designed to avoid potentially harmful lubricants (such as silicone) while minimizing liquid retention.

The autoclavable rack and tubes (not the cover) are ideal for storage of blood and other biological samples at temperatures, from -170 °C. for freezer storage, up to 121 °C. Tubes are available separately. A PVC cover is also supplied for full protection of tube contents. Racks are stackable to save on storage space. Available in sterile and non sterile versions.



- 1- Boxes are stackable for space-saving
- 2- Transparent cover for easy viewing of contents
- 3- Cover and base are keyed to prevent misalignment
- 4- Tubes and rack are autoclavable
- 5- Tubes can easily be inserted and removed
- 6- Alphanumeric identification of each position

Products on this page are certified RNase, DNase, Pyrogen and DNA-free.



Cat. #	Description	Sterile	Qty/Cs
T105-50	96-well BIOTUBE™ storage rack with tubes	No	10
T105-51	96-well BIOTUBE™ storage rack with tubes	Yes	10
T105-20	2.1 ml square tubes	No	4800
T105-20LST	2.1 ml low surface tension square tubes	No	4800





## Tubes & Caps

Tubes are made of autoclavable polypropylene and are available either individually or in strips of 8 or 12 detachable tubes. Tubes have a gross volume of 1.2 ml but with a cap in place, they will hold 1.1 ml. Caps are made of polyethylene and are not autoclavable. They are available individually and also in strips of 8 or 12. For procedures requiring low surface tension such as protein and nucleic acid work, Simport® has developed a special tube (see T100-20LST) using a type of polypropylene specifically designed to avoid potentially harmful lubricants while minimizing liquid retention. T100-20 can be centrifuged up to 2000g.

These tubes are ideal for HTLV-III testing, bacterial and hybridoma cell uptake studies, cell harvesting, pharmaceutical quality control, receptor binding assays, RIA and EIA.

Cat. #	Description	Material	Qty/Bag	Qty/Cs
T100-20	Individual tubes, without writing surface, non sterile, bulk	PP	960	4800
T100-20LST	Low surface tension individual tubes, non sterile, bulk	PP	960	4800
T100-20PR	Individual tubes, with writing surface, non sterile, bulk	PP	960	4800
T100-25	Strips of 8 tubes, without writing surface, non sterile, bulk	PP	120	600
T100-26	Strips of 12 tubes, without writing surface, non sterile, bulk	PP	80	400
T100-28	Individual plug caps, non sterile, bulk	PE	960	4800
T100-30	Strips of 8 plug caps, non sterile, bulk	PE	120	600
T100-35	Strips of 8 plug caps, sterile, bulk	PE	120	600
T100-40	Strips of 12 plug caps, non sterile, bulk	PE	80	400

Products on this page are certified RNase, DNase, Pyrogen and DNA-free.

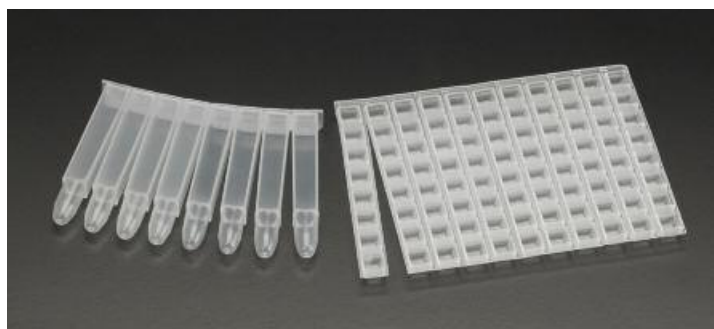

## T105-26

### Mat Cover for T105 Storage Rack

Made of low density polyethylene

Designed to fit the Simport® Biotube™ Storage Rack, these mat covers are made of a specially formulated plastic ensuring great flexibility. When only a few tubes have to be sealed, this flexible mat cover can be split easily in strips of 8 caps.

Cat. #	Description	Sterile	Qty/Cs
T105-26	Mat for T105-50 and T105-51	No	10



# Bioblock<sup>TM</sup> Collection

## THE WIDE VARIETY YOU HAVE BEEN LOOKING FOR

These specially designed non sterile deep well plates are available in polypropylene (model T110-6 is made of polystyrene). They conform to the SBS standard footprint and are identical in size to 96-well microtiter plates. These rugged plates are compatible with all leading robotic sample processors, automated liquid handling systems and 8- & 12-channel pipettors. Will withstand temperatures up to 121 °C (except T110-6 polystyrene plate). Polypropylene plates are fully compatible with deep freezing work, down to -196 °C. Six sizes are available.

All plates offer an alphanumeric grid to help in sample identification. To facilitate orientation, a corner of the plate is cut away. To save space on freezer shelves and on lab benches, they are easily stackable. They can also withstand centrifugation up to 6000g by using microtiter plate rotors. All models are DMSO resistant except cat.# T110-6.

Applications are endless. Designed for high-throughput screening, they are well suited for combinatorial chemistry. They are just the right size for sample storage and automated plate pipetting. Perfect for general procedures requiring a mother plate, DNA sequencing, ELISA, etc...

### The outside dimensions:

The outside dimensions shown on pages 73, 74, 75 and 76 (T110-7 Series) of the base footprint, measured within 12.7 mm (0.5000 inches) of the outside corners, shall be as follows:

- Length 127.76 mm ± 0.25 mm
- Width 85.48 mm ± 0.25 mm

## T110-5

### BioBlock™ Deep Well Plates

Made of polypropylene

The 1.2 ml capacity round bottom deep well plate (1 ml when capped) is easy to empty completely and ideal for culturing bacterial cells. The polypropylene version can withstand centrifugation up to 6000g by using microtiter plate rotors. It is available in natural and four different colors. DMSO resistant.

- Length 127.76 mm ± 0.25 mm
- Width 85.48 mm ± 0.25 mm

Cat. #	Description	Color	Qty/Pk	Qty/Cs
T110-5	Plate, 1.2 ml	Natural	4	24
T110-5B*	Plate, 1.2 ml	Blue	4	24
T110-5G*	Plate, 1.2 ml	Green	4	24
T110-5P*	Plate, 1.2 ml	Pink	4	24
T110-5Y*	Plate, 1.2 ml	Yellow	4	24

\* Minimum quantity applicable. Please contact one of our customer service agents for further details.



Products on this page are certified RNase, DNase, Pyrogen and DNA-free.



## 96 Wells with Round Bottom

127.76 mm ± 0.25 mm

85.48 mm ± 0.25 mm

6.7 mm I.D.

# 1.0 ml WORKING VOLUME

41.6 mm



## T110-6

### BioBlock™ Deep Well Plate

Made of polystyrene



The T110-6 is made of polystyrene and also has 96 x 1.2 ml capacity round bottom wells. It can withstand 3000g and is available in natural color only. Not DMSO resistant. Packed in bags of 4 plates.



Cat. #	Description	Color	Qty/Pk	Qty/Cs
T110-6	Plate, 1.2 ml	Natural	4	24

# DEEP WELL PLATES



## T110-2 & -3

### BioBlock™ Deep Well Plates with 600 µl 8-Tube Strips



Made of polypropylene

These plates feature 600 µl wells for smaller volume applications. They include a T110-5 deep well plate along with twelve T110-15 eight-tube strips (see below). In the T110-2 model, tube strips are removable and can also be ordered separately. In the T110-3 model, tube strips are welded by ultrasound. DMSO resistant. Packed in bags of 4 plates.

Cat. #	Description	Qty/Pk	Qty/Cs
T110-2	Plate, 600 µl (removable tube strips)	4	24
T110-3	Plate, 600 µl (fixed tube strips)	4	24

Products on this page are certified RNase, DNase, Pyrogen and DNA-free.



## 96 Wells with Conical Bottom

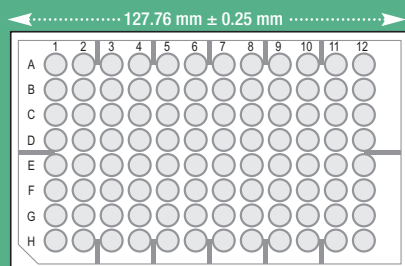

600 µl  
WORKING  
VOLUME

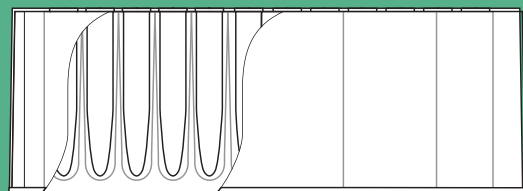

## T321-1 & -2

### Domed and Flat Cap Strips

Made of polypropylene

For a perfect seal, 8-cap strips are available.

Cat. #	Description	Color	Qty/Cs
T321-1N	Domed cap strip	Natural	125
T321-2N	Flat cap strip	Natural	125



## T110-15

### Strip of 8 Tubes 600 µl

Made of polypropylene

Cat. #	Description	Qty/Cs
T110-15	Strip of 8 tubes, 600 µl	125

## T110-10

### BioBlock™ Deep Well Plates

Made of polypropylene

The 2.2 ml well capacity (2.1 ml when capped) plate is used mainly for compound storage and enzyme assays. Suitable to be used with Qiagen equipment. It is available in natural and four different colors.

DMSO resistant. Packed in a bag of 4 plates.

Cat. #	Description	Color	Qty/Pk	Qty/Cs
T110-10	Plate, 2.1 ml	Natural	4	24
T110-10B*	Plate, 2.1 ml	Blue	4	24
T110-10G*	Plate, 2.1 ml	Green	4	24
T110-10P*	Plate, 2.1 ml	Pink	4	24
T110-10Y*	Plate, 2.1 ml	Yellow	4	24

\* Minimum quantity applicable. Please contact one of our customer service agents for further details.



## 96 Square Wells with Round Bottom

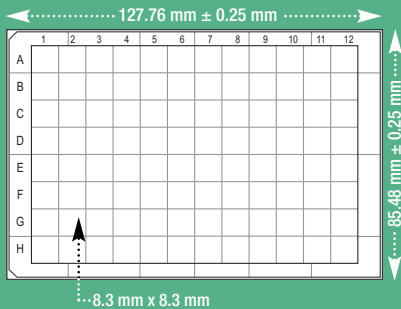

2.0 ml  
WORKING  
VOLUME

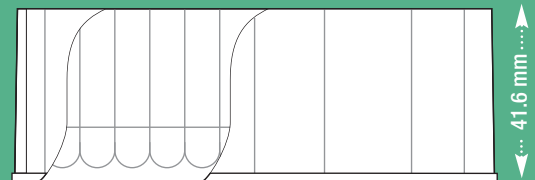

Products on this page are certified RNase, DNase, Pyrogen and DNA-free.



A picture is worth a thousand words.  
A sample, a thousand pictures...

You might look at a picture and read the words under it a thousand times, nothing beats having the product in your own hands for evaluation.

Simport® is proud to offer you the most comprehensive sample program ever developed in the industry. Just for the asking, you can get free of charge a sample of any Simport® product along with a specially designed card describing all the features, benefits and ordering information.

# DEEP WELL PLATES

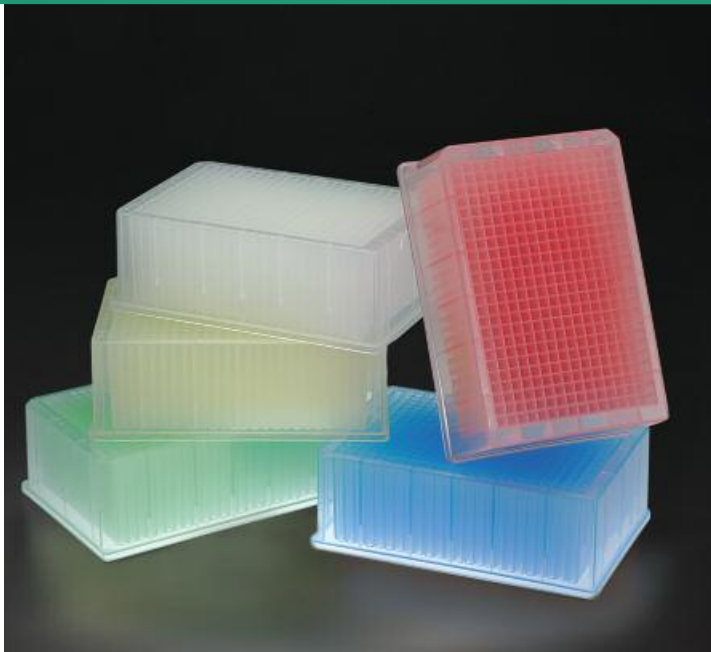

Made of polypropylene

This 384-well plate is available in 3 models from a working volume of 120 µl to 400 µl. It is perfect for compound storage and handling of biological samples. Well bottom is round (except for T110-100) to facilitate aspiration. Suitable to be used with DMSO and biological buffers. Packed in a bag of 4 plates.

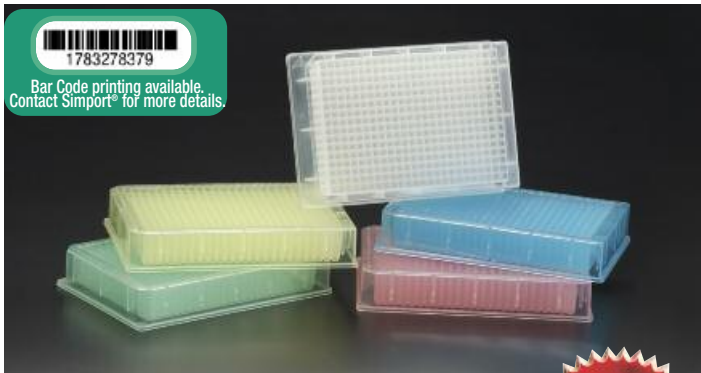

## T110-7, -100 & -200 BioBlock™ Deep Well Plates



### 384 Square Wells with Round Bottom

400 µl  
WORKING  
VOLUME

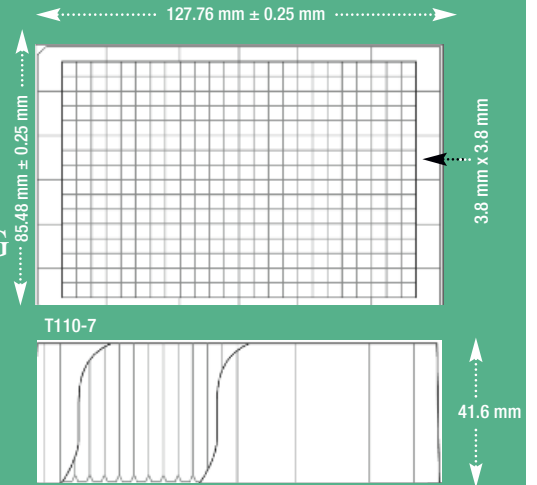

### 384 Square Wells with Round Bottom

200 µl  
WORKING  
VOLUME

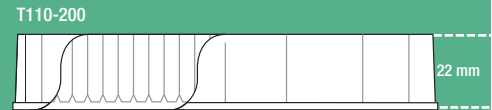

Products on this page are certified RNase, DNase, Pyrogen and DNA-free.

### 384 Square Wells with Flat Bottom

120 µl  
WORKING  
VOLUME



Cat. #	Description	Color	Qty/Pk	Qty/Cs	Cat. #	Description	Color	Qty/Pk	Qty/Cs
T110-7	Plate 400 µl	Natural	4	24	T110-100P*	Plate 120 µl	Pink	4	24
T110-7B*	Plate 400 µl	Blue	4	24	T110-100Y*	Plate 120 µl	Yellow	4	24
T110-7G*	Plate 400 µl	Green	4	24	T110-200	Plate 200 µl	Natural	4	24
T110-7P*	Plate 400 µl	Pink	4	24	T110-200B*	Plate 200 µl	Blue	4	24
T110-7Y*	Plate 400 µl	Yellow	4	24	T110-200G*	Plate 200 µl	Green	4	24
T110-100	Plate 120 µl	Natural	4	24	T110-200P*	Plate 200 µl	Pink	4	24
T110-100B*	Plate 120 µl	Blue	4	24	T110-200Y*	Plate 200 µl	Yellow	4	24
T110-100G*	Plate 120 µl	Green	4	24					

\*Minimum quantity applicable. Please contact one of our customer service agents for further details.

## T110-25, -26, -27 & -37 Mat Covers for Deep Well Plates

Designed to fit the Simport® Bioblock™ Family, these mat covers are made of a specially formulated plastic ensuring great flexibility. They allow for maximum sample volume in each well. They are resistant to DMSO and biological buffers.

T110-25, T110-26 and T110-27 are made of polyolefin and Elastomer. They should be used within a temperature range of -80 °C to +80 °C.

The T110-37 is made of thermoplastic rubber and will resist temperatures from -170 °C to +121 °C. Only the T110-37 is autoclavable.

Cat. #	Description	Qty/Cs
T110-25	For 1.2 ml 96-well plates	24
T110-26	For 2.1 ml 96-well plates	24
T110-27	For 120 µl to 400 µl 384-well plates	24
T110-37	For 120 µl to 400 µl 384-well plates	24



## T329-3 & -4

### SecureSeal™ Adhesive Film for Microplates

Simport® adhesive sealing films reduce sample-to-sample or well-to-well contamination and/or spill over. SecureSeal™ is economically priced and has the differential advantage of perforated end tabs and a multiple split backing which allow for easier and more accurate positioning and more secure sealing. The polyester based film with acrylic adhesive is inert and thus compatible with almost all microplate procedures. The functional temperature range of the product is -40 °C to +120 °C. SecureSeal™ is less than .001% moisture permeable under high humidity conditions and less than .01% oxygen permeable. DMSO resistant. Each package contains 100 sheets. Use T329-9 Amplate™ Roller for a perfect seal.

Cat. #	Description	Sterile	Qty/Pk	Qty/Cs
T329-3	SecureSeal™	No	100	1000
T329-4	SecureSeal™	Yes	100	1000

## T329-5 SecureSeal™ Aluminium Sealing Foil

This type of material is ideal for manual sealing during PCR work and also for high throughput applications. Adhesive backing makes it easy to apply. Will resist temperatures from -80 °C to +120 °C. Pierceable with a pipet tip for easy access to sample. DMSO resistant.

It is recommended to use the Amplate™ Roller (T329-9) to ensure a perfect bond, eliminating the danger of evaporation. No heat sealer needed.

Cat. #	Description	Qty/Pk
T329-5	Peeling foil	100 sheets

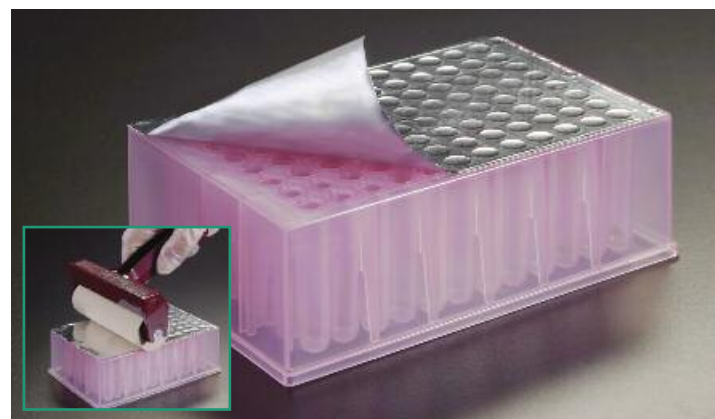

## T329-9 AMPLATE™ Roller

For ensuring a perfect seal when using either SecureSeal™ sealing film or aluminum foil on microtiter or deep well plates. Roller made of medial hard rubber. Heavy-duty handle with comfort grip reducing fatigue. Will last a long time.

Cat. #	Size	Qty/Pk
T329-9	10.16 cm (4 in.)	1



Products on this page are certified RNase, DNase, Pyrogen and DNA-free.

## SIMPORT® CAN CUSTOMIZE YOUR BAR CODING NEEDS



A barcode is a piece of automatic identification technology that stores information. Barcodes are "machine-readable codes" which can be used to reduce errors, process many samples, track products etc... Simport® offers customised bar-coded products such as Cryogenic Vials, Microcentrifuge Tubes, Sample Tubes or any other tubes with a white background on which the barcode can be printed.

### Why use bar codes?

Bar codes play an essential role in tracking samples. They provide a tool for reviewing the large quantities of data. A bar code provides the safest way to keep track of your sample. The code is extremely durable and will help reduce human errors. Bar-coded products are suitable for automation or manual operations. Some bar-coded products provide a trouble-free human readable code, which can be read and manually entered when a scanner is not available.

### Other advantages of using barcodes are:

- Reduce human errors
- Improve efficiency: manual and automatic
- Improve quality controls
- Reduce handling costs
- Demotivating job functions are reduced
- All barcodes have "visual-readable-numbers".

Bar codes are placed on tubes in the following way: First, a white background is pad-printed directly on the tube, then the Ink Jet technique is used to print the black codes on the white background. These codes can withstand the same temperature fluctuations that a Cryovial would in liquid nitrogen and the following defrosting.

Barcoded tubes are packaged in bags of 100. A label is placed on each bag indicating sequential numbering (ex. 100000 to 100099).

### Available Codes

We offer two different code types:



Alphanumeric printing is also available on many of our products. Contact Simport® for further details.

### Code 128C

This is an alphanumeric code, meaning that it contains both numbers and characters/letters. Code 128C characters comprise three bars and three spaces. Code 128C is our recommended barcode of choice because of the compressed design, widely supported, flexibility and data security.

### Interleaved 2 of 5

This code is numerical (no letters) and self-checking to improve the data security. Each Interleaved 2 of 5 character encodes two digits (one in the bars and one in the spaces) and therefore the code has a higher density. Interleave 2 of 5 always requires an equal number of characters (including check digit) to be printed. Due to the design of Interleaved 2 of 5 there is a risk of truncation of the sequence when scanned, which is why Simport® recommends a check digit and that a fixed number of digits mode is chosen in the reading software if possible.



# New Products



C566  
Page 13



B350ECO  
Page 5



M478  
Page 44



M513-2  
Page 42



M795-1  
Page 45



M961  
Page 55



S700  
Page 68



T323  
Page 104

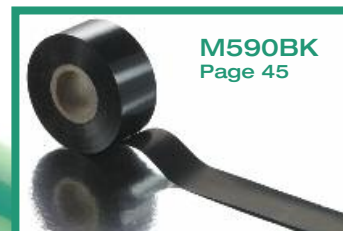

M590BK  
Page 45

and many more!



# Cryovial® Collection

The Simport® Cryovial® Family is the most complete line of cryogenic vials available today. Designed for storing cells, blood, serum and other biological fluids at temperatures as low as  $-196^{\circ}\text{C}$ , these sturdy polypropylene vials offer a high level of chemical resistance.

As described in the following pages, they are available in 3 different configurations and in 5 sizes from 1.2 ml to 5 ml. A large white marking area and printed graduations facilitate sample identification. Some models are free-standing while some others have only a round bottom. Self-standing vials have a locking base allowing opening and closing with only one hand while vials are used with the Simport® Workstation.

One important feature in the Simport® Cryovial® design is being able to manufacture both the tube and cap from the same plastic, ensuring the same expansion coefficient, therefore a lasting seal.\*

\* The Cryolock vial has a polyethylene cap.

**WARNING:** Do not use Cryovials for storage in the liquid phase of liquid nitrogen. Such use may cause entrapment of liquefied nitrogen inside the vial and lead to pressure build-up resulting in possible explosion or biohazard release. Use appropriate safety procedures when handling and disposing of vials.

## T309

### CRYOVIAL®

#### External Thread Design with Lip Seal



Made of specially formulated polypropylene

Designed for storing biological material, human or animal cells, at temperatures as low as -196 °C (but should be used only in the gas phase of liquid nitrogen). The cap features a long skirt for one hand aseptic methods, and a super fast thread design that allows tightening or removal with a mere 1¼ turn, and an inside thread design that will not contribute to possible contamination. A specially designed lip inside the cap ensures a leakproof seal even at very low temperatures. Closures and tubes are both made of polypropylene having the same coefficient of expansion, which further enhances the leakproof qualities of these vials at various temperatures. Tubes are provided with a white marking area for sample identification and can be color coded by the use of a CAPINSERT™ (Series T312). T309-2 can be centrifuged up to 17,000g. Vials are sterilized by gamma radiation and are packaged in unique tamperproof, resealable, safety-lock bags of 100. Autoclavable

Tubes on this page are certified RNase, DNase, Pyrogen and DNA-free



For Capinsert™, please refer to T312 on page 98.

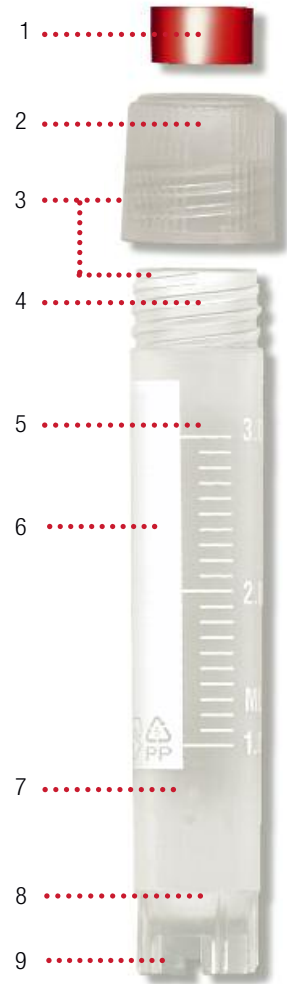
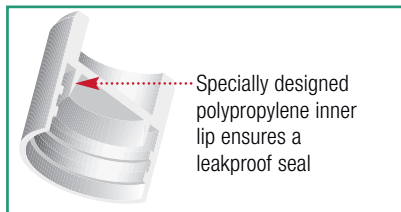

- 1- A CAPINSERT™ is available in 11 different colors / Perfect for color coding (See T312 Series on page 98)
- 2- Vertical ribs facilitate cap removal
- 3- Both cap and tube are made of same polypropylene material, therefore same coefficient of expansion ensures secure seal at all temperatures
- 4- Super fast 1¼ turn thread design
- 5- Thick wall makes vial almost unbreakable
- 6- Large white marking area
- 7- Excellent clarity makes sample easy to see
- 8- Round bottom / Very easy to empty contents completely
- 9- Many sizes available as self-standing with universal locking base

For IVD use

Cat. #	T309-1A	T309-2	T309-2A	T309-3A	T309-4A	T309-5A
Volume (ml)	1.2	2	2	3	4	5
Size (mm)	12.5 x 42	12.5 x 47	12.5 x 49	12.5 x 71	12.5 x 77	12.5 x 91
Self-Standing	•		•	•	•	•
Round Bottom		•				
Qty/Bag	100	100	100	100	100	100
Qty/Cs	1000	1000	1000	1000	1000	1000

## T301

### CRYOVIAL®

#### Internal Thread Design with Silicone O-ring Seal



Specially formulated polypropylene

Designed for safe storage at temperatures as low as -196 °C (but should be used only in the gas phase of liquid nitrogen). Only 1 1/4 turn of the cap is sufficient to screw the cap on the vial. The specially formulated silicone o-ring ensures a positive leakproof seal at all temperatures. Closure and vial are both made of polypropylene having the same coefficient of expansion, ensuring an equally secure seal both at room temperature and at low cryogenic temperatures. Tubes have a white marking area, can be color coded with a CAPINSERT (Series T312) and are compatible with most storage systems. Only the non skirted vials can be centrifuged, and up to 17,000g. Sterilized by gamma radiation and packaged in unique tamperproof, resealable, safety-lock bags of 100. Autoclavable.

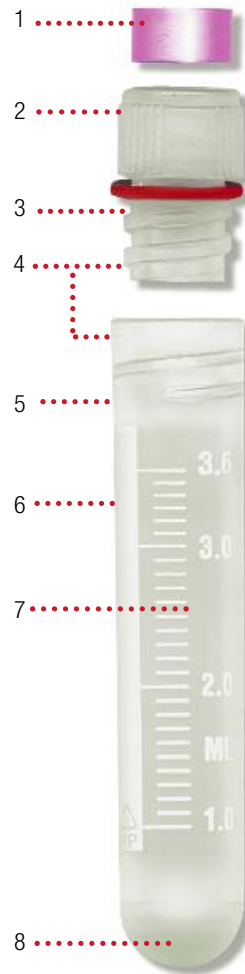

- 1- A CAPINSERT™ is available in 11 different colors Perfect for color coding (See T312 Series on page 98)
- 2- Vertical ribs facilitate cap removal
- 3- Super fast 1 1/4 turn thread design
- 4- Both cap and tube are made of same polypropylene material, therefore same coefficient of expansion ensures secure seal at all temperatures
- 5- Thick wall makes vial almost unbreakable
- 6- Large white marking area
- 7- Excellent clarity makes sample easy to see
- 8- Round bottom / Very easy to empty contents completely / Two sizes are self-standing with universal locking base

Tubes & caps on this page are certified RNase, DNase, Pyrogen and DNA-free



Feel the quality of your seal!

1. A positive leakproof seal is enhanced by a specially designed silicone o-ring around the cap.
2. As you tighten it, you can feel the quality of your seal while you compress the o-ring between the tube wall and the cap, creating a tight closure.



For IVD use

Cat. #	T301-1	T301-2	T301-3	T301-4	T301-4A	T301-5
Volume (ml)	1.2	2	2	4	4	5
Size (mm)	12.5 x 41	12.5 x 49	12.5 x 48	12.5 x 70	12.5 x 72	12.5 x 90
Self-Standing	•	•			•	
Round Bottom			•	•		•
Qty/Bag	100	100	100	100	100	100
Qty/Cs	1000	1000	1000	1000	1000	1000



## T311

### CRYOVIAL®

#### Internal Thread Design with Silicone Washer Seal



Specially formulated polypropylene

Designed for storing biological material, human or animal cells, at temperatures as low as -196 °C (but should be used only in the gas phase of liquid nitrogen). A silicone washer between cap and vial ensures a positive leakproof seal at all temperatures. A 1 ¼ turn of the cap is sufficient to seal the vial. Closure and vials are both manufactured of polypropylene with the same coefficient of expansion, ensuring an equally secure seal both at room temperature and at low cryogenic temperatures. Tubes have a white marking area, can be color coded with a CAPINSERT™ (Series T312) and are compatible with most storage systems. Only the round bottom vials can be centrifuged, and up to 17,000g. Sterilized by gamma radiation and packaged in unique tamperproof, resealable, safety-lock bags of 100. Autoclavable.



1. This cap offers a positive seal using a white silicone washer.
2. When the cap is screwed on, the white washer is tightly secured between cap and top of tube.

Tubes & caps on this page are certified RNase, DNase, Pyrogen and DNA-free



- 1- A CAPINSERT™ is available in 11 different colors / Perfect for color coding (See T312 Series on page 98)
- 2- Vertical ribs facilitate cap removal
- 3- Silicone washer
- 4- Super fast 1 ¼ turn thread design
- 5- Both cap and tube are made of same polypropylene material, therefore same coefficient of expansion ensures secure seal at all temperatures
- 6- Thick wall makes vial almost unbreakable
- 7- Large white marking area
- 8- Excellent clarity makes sample easy to see
- 9- Round bottom / Very easy to empty contents completely



For IVD use CE

Cat. #	T311-1	T311-2	T311-3	T311-4	T311-4A	T311-5
Volume (ml)	1.2	2	2	4	4	5
Size (mm)	12.5 x 41	12.5 x 49	12.5 x 48	12.5 x 70	12.5 x 72	12.5 x 90
Self-Standing	•	•			•	
Round Bottom			•	•		•
Qty/Bag	100	100	100	100	100	100
Qty/Cs	1000	1000	1000	1000	1000	1000



For Capinsert™, please refer to T312 on page 98.

# CRYOGENIC VIALS

## T308 CRYOVIAL®

### External Thread Design with Lip and Silicone Washer Seal



Made of specially formulated polypropylene

Designed for the storage of biological material, human or animal cells, at temperatures as low as -196 °C (but should be used only in the gas phase of liquid nitrogen). The cap features a long skirt for easy one-handed aseptic technique, a super fast thread design allowing removal with only 1¼ turn, and an inside thread design that will not contribute to possible contamination. This cap also features an exclusive silicone washer fitted inside the cap to ensure a positive seal at any temperature, even the lowest of cryogenic temperatures. The tubes are provided with a white marking area for sample identification and can be color coded by the use of a CAPINSERT™ (Series T312 for choice of available colors). T308-2 can be centrifuged up to 17,000g. Vials are sterilized by gamma radiation and are packaged in unique tamperproof, resealable safety-lock bags of 100. Autoclavable

Tubes & caps on this page are certified RNase, DNase, Pyrogen and DNA-free



For Capinsert™, please refer to T312 on page 98.

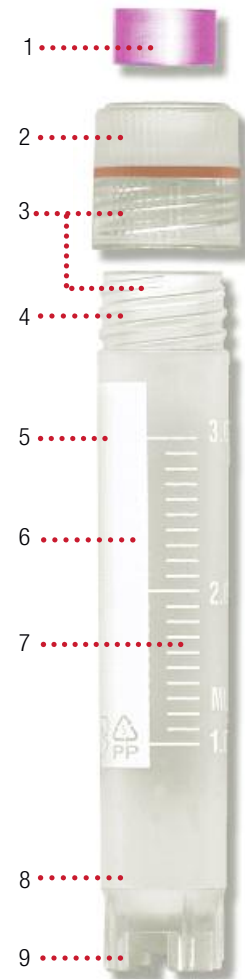
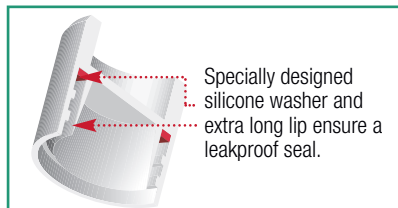

- 1- A CAPINSERT™ is available in 11 different colors / Perfect for color coding (See T312 Series on page 98)
- 2- Vertical ribs facilitate cap removal
- 3- Both cap and tube are made of same polypropylene material, therefore same coefficient of expansion ensures secure seal at all temperatures
- 4- Super fast 1¼ turn thread design
- 5- Thick wall makes vial almost unbreakable
- 6- Large white marking area
- 7- Excellent clarity makes sample easy to see
- 8- Round bottom / Very easy to empty contents completely
- 9- Many sizes available as self-standing with universal locking base



For IVD use

Cat. #	T308-1A	T308-2	T308-2A	T308-3A	T308-4A	T308-5A
Volume (ml)	1.2	2	2	3	4	5
Size (mm)	12.5 x 42	12.5 x 47	12.5 x 49	12.5 x 71	12.5 x 77	12.5 x 91
Self-Standing	•		•	•	•	•
Round Bottom		•				
Qty/Bag	100	100	100	100	100	100
Qty/Cs	1000	1000	1000	1000	1000	1000



## T310 CRYOVIAL® External Thread Design with Silicone Washer Seal



Made of specially formulated polypropylene

Designed for storing biological material, human or animal cells, at temperatures as low as -196 °C (but should be used only in the gas phase of liquid nitrogen). The cap features a long skirt for easy one hand aseptic methods, the same super fast thread design allowing it to be removed or sealed with a mere 1¼ turn, and the same inside thread design that will not contribute to possible contamination. But this cap also features an exclusive silicone seal fitted inside the cap to ensure a positive seal at any temperature, even the lowest of cryogenic temperatures. Please note that model T310-10A has a polyethylene screw cap. Tubes are provided with a white marking area for sample identification and can be color coded by the use of a CAPINSERT™ (Series T312). The Simport® CRYOVIAL® is compatible with most storage systems. T310-2 can be centrifuged up to 17,000g. Vials are sterilized by gamma radiation and are packaged in unique tamperproof, resealable, safety-lock bags of 100. Autoclavable.



Tubes & caps on this page are certified RNase, DNase, Pyrogen and DNA-free



- 1- A CAPINSERT™ is available in 11 different colors / Perfect for color coding (See T312 on page 98)
- 2- Vertical ribs facilitate cap removal
- 3- Silicone washer
- 4- Both cap and tube are made of same polypropylene material, therefore same coefficient of expansion ensures secure seal at all temperatures
- 5- Super fast 1 ¼ turn thread design
- 6- Thick wall makes vial almost unbreakable
- 7- Large white marking area
- 8- Excellent clarity makes sample easy to see
- 9- Round bottom / Very easy to empty contents completely
- 10- Many sizes available as self-standing with universal locking base



Cat. #	T310-1A	T310-2	T310-2A	T310-3A	T310-4A	T310-5A	T310-10A
Volume (ml)	1.2	2	2	3	4	5	10
Size (mm)	12.5 x 42	12.5 x 47	12.5 x 49	12.5 x 71	12.5 x 77	12.5 x 91	17 X 84
Self-Standing	•		•	•	•	•	•
Round Bottom		•					
Qty/Bag	100	100	100	100	100	100	50
Qty/Cs	1000	1000	1000	1000	1000	1000	500

For IVD use

# STORAGE BOXES

## T314 CRYOSTORE™ Storage Boxes

Made of polycarbonate

Color your world with a wide variety of Cryostore™ Storage Boxes for sizes from 1.2 ml to 5 ml.

Made of extra strong polycarbonate, these durable cryogenic storage boxes are designed to be used at temperatures between -196 °C and +121 °C and are autoclavable at 120 °C, 15 psig (1 bar) for 20 minutes. Different models are available to accommodate either 25, 81 or 100 Cryovial® tubes from 1.2 ml to 5 ml.

A transparent cover allows the user to see the contents of the box, and is keyed to the base to prevent misalignment. Printed with a series of squares (numbered from 1 to 25, 1 to 42, 1 to 81, or 1 to 100), surface accepts writing with markers, facilitating inventory control.

A unique color coding system uses colored plastic grids to separate the cover from the base on the 25, 42 and 81-place boxes. Those made to accept 100 tubes (series 2100) have a colored base instead of a grid. Removal of vials facilitated by an innovative vial picker supplied with each storage box (not available with box T314-542). A choice of four popular pastel colors is available. Autoclavable.

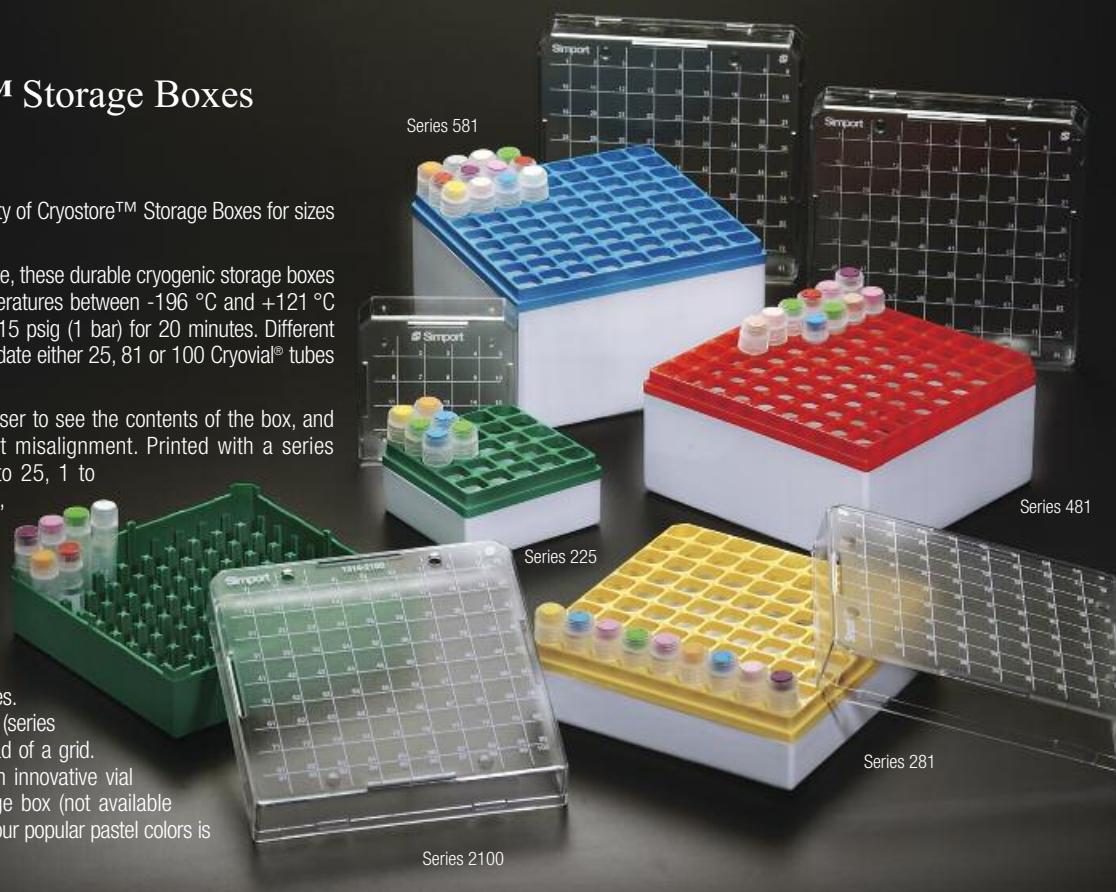

Storage Box on this page are certified RNase, DNase, Pyrogen and DNA-free

### Features and benefits of 25- and 81-Place CRYOSTORE™ Storage Boxes

- 1- Writing surface has numbered squares for easy sample identification
- 2- Stackable
- 3- Vials readily visible through transparent cover
- 4- Four colors available for better color-coding
- 5- Cover and base are keyed to prevent misalignment
- 6- Drain holes under base
- 7- Made to fit freezer metal racks
- 8- Writing surface for identifying base and/or cover
- 9- Numeric identification of each vial
- 10- Air vents minimizing condensation



A Vial Picker is included with each StoreBox™.

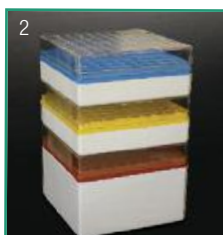

All CRYOSTORE™ Storage Boxes are easily stackable.

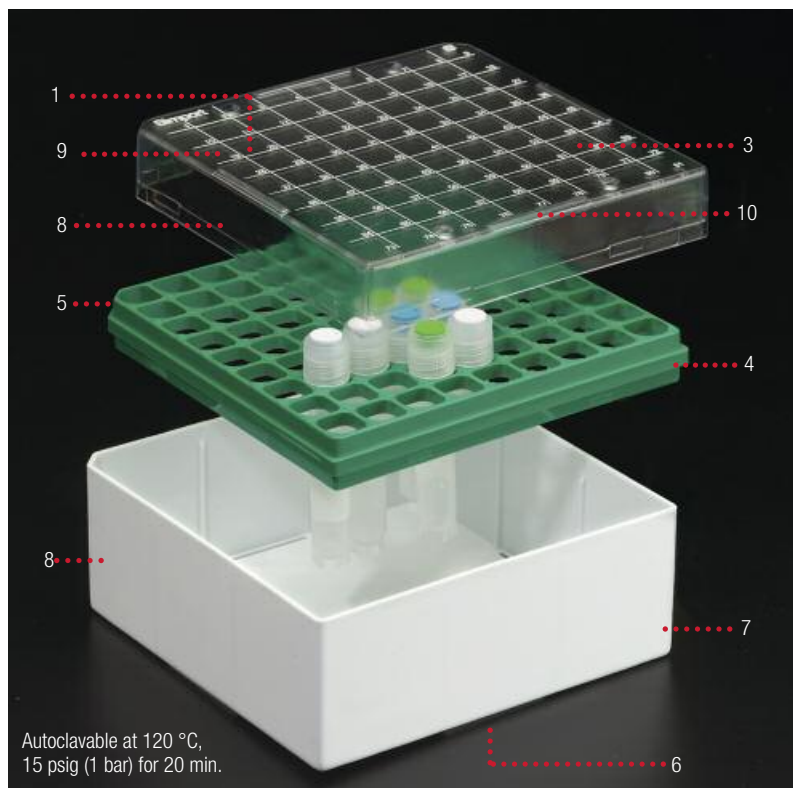

Autoclavable at 120 °C, 15 psig (1 bar) for 20 min.



## T314-542 CRYOSTORE™ Storage Box

Made of polycarbonate

Made of extra strong polycarbonate, these durable cryogenic storage boxes are designed to be used at temperatures between -196 °C and +121 °C and are autoclavable at 120 °C, 15 psig (1 bar) for 20 minutes. Different colors are available to accommodate 42 x T310-10A cryogenic tubes.

A transparent cover allows the user to see the contents of the box, and is keyed to the base to prevent misalignment. Printed with a series of squares numbered from 1 to 42, the surface accepts writing with markers, facilitating inventory control.

A unique color coding system uses colored plastic grids to separate the cover from the base on the box. A choice of four popular colors is available.



Series 225: Size: 76 mm x 76 mm x 52 mm H (3 x 3 x 2 1/16 in. H)

Cat. #	For cryogenic tubes	Color of grid	Qty/Pk	Qty/Cs
T314-225B	1 to 2 ml	Blue	8	48
T314-225G	1 to 2 ml	Green	8	48
T314-225R	1 to 2 ml	Red	8	48
T314-225Y	1 to 2 ml	Yellow	8	48

Series 542: Size: 133 mm x 133 mm x 95 mm H (5 1/4 x 5 1/4 x 3 3/4 in. H)

Cat. #	For cryogenic tubes	Color of grid	Qty/Pk	Qty/Cs
T314-542B	10 ml	Blue	5	10
T314-542G	10 ml	Green	5	10
T314-542R	10 ml	Red	5	10
T314-542Y	10 ml	Yellow	5	10

Series 281: Size: 133 mm x 133 mm x 52 mm H (5 1/4 x 5 1/4 x 2 1/16 in. H)

Cat. #	For cryogenic tubes	Color of grid	Qty/Pk	Qty/Cs
T314-281B	1 to 2 ml	Blue	4	24
T314-281G	1 to 2 ml	Green	4	24
T314-281R	1 to 2 ml	Red	4	24
T314-281Y	1 to 2 ml	Yellow	4	24

Series 581: Size: 133 mm x 133 mm x 95 mm H (5 1/4 x 5 1/4 x 3 3/4 in. H)

Cat. #	For cryogenic tubes	Color of grid	Qty/Pk	Qty/Cs
T314-581B	3 to 5 ml	Blue	5	10
T314-581G	3 to 5 ml	Green	5	10
T314-581R	3 to 5 ml	Red	5	10
T314-581Y	3 to 5 ml	Yellow	5	10

Series 481: Size: 133 mm x 133 mm x 81 mm H (5 1/4 x 5 1/4 x 3 1/8 in. H)

Cat. #	For cryogenic tubes	Color of grid	Qty/Pk	Qty/Cs
T314-481B	3 to 4 ml	Blue	3	12
T314-481G	3 to 4 ml	Green	3	12
T314-481R	3 to 4 ml	Red	3	12
T314-481Y	3 to 4 ml	Yellow	3	12

Series 2100: Size: 133 mm x 133 mm x 52 mm H (5 1/4 x 5 1/4 x 2 1/16 in. H)

Cat. #	For cryogenic tubes*	Color of grid	Qty/Pk	Qty/Cs
T314-2100B	1 to 2 ml	Blue	4	24
T314-2100G	1 to 2 ml	Green	4	24
T314-2100R	1 to 2 ml	Red	4	24
T314-2100Y	1 to 2 ml	Yellow	4	24

\* T301 and T311 Series only.





















**A picture is worth a thousand words.  
A sample, a thousand pictures...**

You might look at a picture and read the words under it a thousand times, nothing beats having the product in your own hands for evaluation.

Simport® is proud to offer you the most comprehensive sample program ever developed in the industry. Just for the asking, you can get free of charge a sample of any Simport® product along with a specially designed card describing all the features, benefits and ordering information.



# Box Selection Guide

																	
T309-1A	T309-2	T309-2A	T309-3A	T309-4A	T309-5A	T301-1	T301-2	T301-3	T301-4	T301-4A	T301-5	T311-1	T311-2	T311-3	T311-4	T311-4A	T311-5
1.2 ml	2 ml	2 ml	3 ml	4 ml	5 ml	1.2 ml	2 ml	2 ml	4 ml	4 ml	5 ml	1.2 ml	2 ml	2 ml	4 ml	4 ml	5 ml
●	●	●				●	●	●				●	●	●			
●	●	●				●	●	●				●	●	●			
			●	●					●	●					●	●	
			●	●	●						●						●
						●	●	●				●	●	●			

## T312

### CAPINSERT™ for CRYOVIAL® Tubes

Made of polypropylene

Color coded inserts fit precisely into the cap of the Cryovial® for color identification.

Cat. #	Color	Qty/Bag	Cat. #	Color	Qty/Bag
T312-1	White	500	T312-8	Tan	500
T312-2	Blue	500	T312-9	Gray	500
T312-3	Red	500	T312-10	Lilac	500
T312-4	Green	500	T312-11	Burnt orange	500
T312-5	Yellow	500	T312-13	Violet	500
T312-7	Assortment of colors above	5 bags of 100	T312-14	Pink	500



## T313

### Cane for CRYOVIAL® Tubes

Made of aluminum

For storage of up to five 1.2 or 2 ml Simport® Cryovial® tubes in liquid nitrogen containers such as Dewar flasks.

Cat. #	Length	Qty/Pk	Qty/Cs
T313	290 mm (11 5/16 in.)	12	48



## T315

### CRYOVIAL® Workstation Rack

Made of polypropylene

This handy autoclavable rack can hold up to 50 cryogenic vials. Now with one hand, you can easily unscrew a Simport® Cryovial® closure. Thanks to an innovative universal locking system, the vials will securely lock in each well and will not turn. Each position is identified with an alphanumeric index. Strong handles make it easy and safe to carry. It is supported by anti-skid rubber feet. The rack is compact and stackable. Available in three attractive colors.

Size: 10 cm x 20 cm x 25 mm H (4 x 8 x 1 in. H)



Now, with only one hand, you can easily unscrew a Simport® Cryovial® closure. Thanks to an innovative universal locking base, the vials will securely lock in the wells of just about any rack on the market. This newly designed feature is available on all Simport® self-standing Cryovial® tubes.

Cat. #	Color	Qty/Cs
T315-2	Blue	4
T315-3	Red	4
T315-10	Lilac	4



# PCR<sup>®</sup> Collection

## The assurance of highly accurate and contaminant-free procedures

Driven by innovation, research and product development, Simport<sup>®</sup> is a world leading laboratory products design and manufacturing company. Since 1975, Simport<sup>®</sup> has developed, manufactured and marketed a broad range of innovative disposables to improve research techniques and methods. Our products are distributed worldwide through reputable laboratory and medical products distributors. Some of our superior quality products are also distributed under private label by some of the world's leading laboratory products manufacturers and suppliers.

All Simport<sup>®</sup> PCR<sup>®</sup> products are designed and manufactured to the highest quality standards and to precise calibration and dimensional accuracy. Made under the most rigid manufacturing conditions. The Simport<sup>®</sup> PCR<sup>®</sup> Family was developed to help the researcher, analyst and technician obtain accurate and repeatable results from experimentation, testing and analysis.

PCR tubes, strips and plates are also available sterile on special request. When placing your order, please check with Customer Service to find out minimum quantities and expected delivery.



## T325-1 & -2 AMPLITUBE™ PCR Reaction Tubes, 0.2 ml

Made of polypropylene

Designed for oil-free operation, these tubes are made of transparent superior quality grade polypropylene for better viewing of the contents. Their ultrathin wall design will ensure rapid thermal transfer and a significant reduction in cycle and PCR reaction time.

Attached hinged caps are either dome or flat-topped and can be used with heated lids used by thermal cycler manufacturers. They provide positive sealing during thermal cycling and will prevent evaporation while being easily opened and closed with one hand. The cap has an integral shield preventing contamination with surface of lid. Frosted writing surface for sample identification.

Choice of colorless and four non-cytotoxic and non-metallic colors. Packaged in tamperproof resealable safety-lock bags.

Cat. # Domed Cap	Cat. # Flat Cap	Color	Qty/Pk
T325-1N	T325-2N	Natural	1000
T325-1B	T325-2B	blue	1000
T325-1G	T325-2G	Green	1000
T325-1R	T325-2R	Red	1000
T325-1Y	T325-2Y	Yellow	1000

The cap has an integral shield preventing contamination with surface of lid.

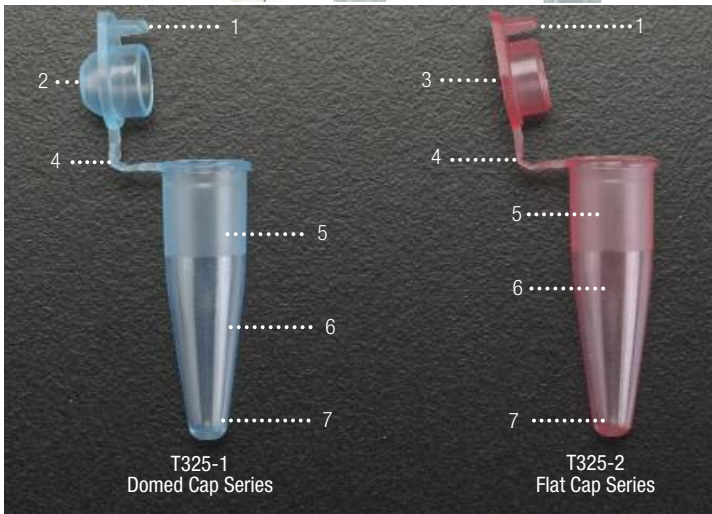

- 1 Integral shield prevents contamination with surface of lid
- 2 Domed cap provides a snap shut positive seal
- 3 Pierceable flat cap
- 4 Attached cap allows opening and closing with one hand
- 5 Frosted writing surface
- 6 Ultrathin wall ensures excellent thermal exchange
- 7 Round bottom makes tube easy to empty

Tubes on this page are certified  
RNase, DNase,  
Pyrogen and DNA-free



## T325-1V & -2V AMPLITUBE™ PCR Reaction Tubes, 0.2 ml

Made of polypropylene

Ideal tube design when centrifugation is necessary. These tubes are identical to the T325-1 & -2 Series but without a contamination shield. Frosted writing surface for sample identification. See description above for further details. Packaged in tamperproof resealable safety-lock bags.

Cat. # Domed Cap	Cat. # Flat Cap	Color	Qty/Pk
T325-1VN	T325-2VN	Natural	1000
T325-1VB	T325-2VB	Blue	1000
T325-1VG	T325-2VG	Green	1000
T325-1VR	T325-2VR	Red	1000
T325-1VY	T325-2VY	Yellow	1000

## T325-12 AMPLITUBE™ PCR Reaction Tubes 0.2 ml (without cap)

Made of polypropylene

This thin wall 0.2 ml tube is very useful when processing smaller volumes. It offers optimum contact with thermal cycler blocks. The ultrathin wall will ensure rapid thermal transfer and a significant reduction in cycle and PCR reaction time. Specially designed with a highly polished surface and a round bottom for maximum sample recovery. Sealing can be achieved by using either T321-1 or T321-2 Series Cap Strips. Choice of colorless and four non-cytotoxic and non-metallic colors. Packed in tamperproof resealable bags.



Cat. #	Color	Qty/Pk
T325-12N	Natural	1000
T325-12B	Blue	1000
T325-12G	Green	1000
T325-12R	Red	1000
T325-12Y	Yellow	1000

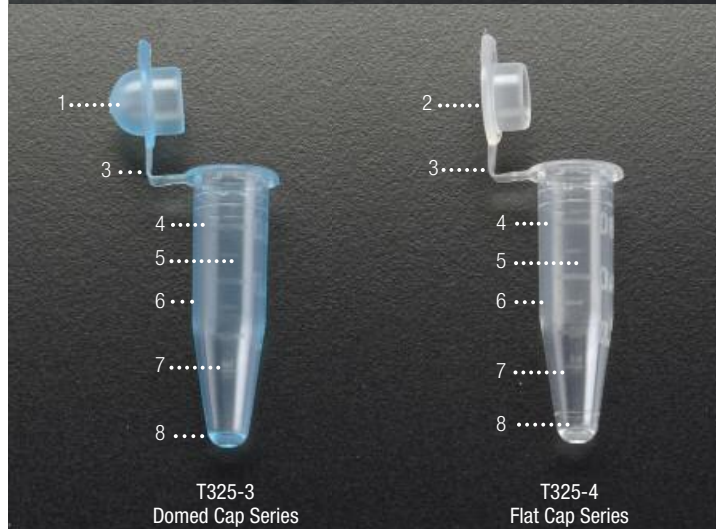

## T325-3 & -4 AMPLITUBE™ PCR Reaction Tubes, 0.5 ml

Made of polypropylene

Also designed for oil-free operation, the inside of these tubes has a polished surface, a conical shape and a round bottom for maximum sample recovery. They offer optimum contact with thermal cycler blocks. Their ultrathin wall design will ensure rapid thermal transfer and a significant reduction in cycle and PCR reaction time. Graduated in 0.1 ml increments.

Attached hinged caps are either dome or flat-topped and provide positive sealing during thermal cycling stages. They will prevent evaporation while being easily opened and closed with one hand. Choice of colorless and four non-cytotoxic and non-metallic colors for visual coding of samples. Packed in tamperproof resealable bags. Autoclavable.

- 1 Domed cap provides a snap shut positive seal
- 2 Pierceable flat cap
- 3 Attached cap allows opening and closing with one hand
- 4 Etched writing surface for sample identification
- 5 Graduated in 0.1 ml increments
- 6 Ultrathin wall
- 7 See-thru polypropylene
- 8 Round bottom makes tube easy to empty

Tubes on this page are certified  
RNase, DNase,  
Pyrogen and DNA-free

Cat. # Domed Cap	Cat. # Flat Cap	Color	Qty/Pk
T325-3N	T325-4N	Natural	1000
T325-3B	T325-4B	Blue	1000
T325-3G	T325-4G	Green	1000
T325-3R	T325-4R	Red	1000
T325-3Y	T325-4Y	Yellow	1000

### Three versatile racks to accommodate your PCR tubes, strips and plates.



See page 110

The Unirack™ is an almost universal support holding up to 60 PCR reaction tubes between 0.2 ml and 0.5 ml capacity.



See page 110

The Combi-Rack™ can hold up to 96 0.2 ml PCR tubes and 8- or 12- tube strips.



See page 110

The PCRRack™ will accept all models of 0.2 ml tubes, along with strips of 8 or 12 tubes and 96-well plates.

## T320 AMPLITUBE™ PCR Reaction Strips

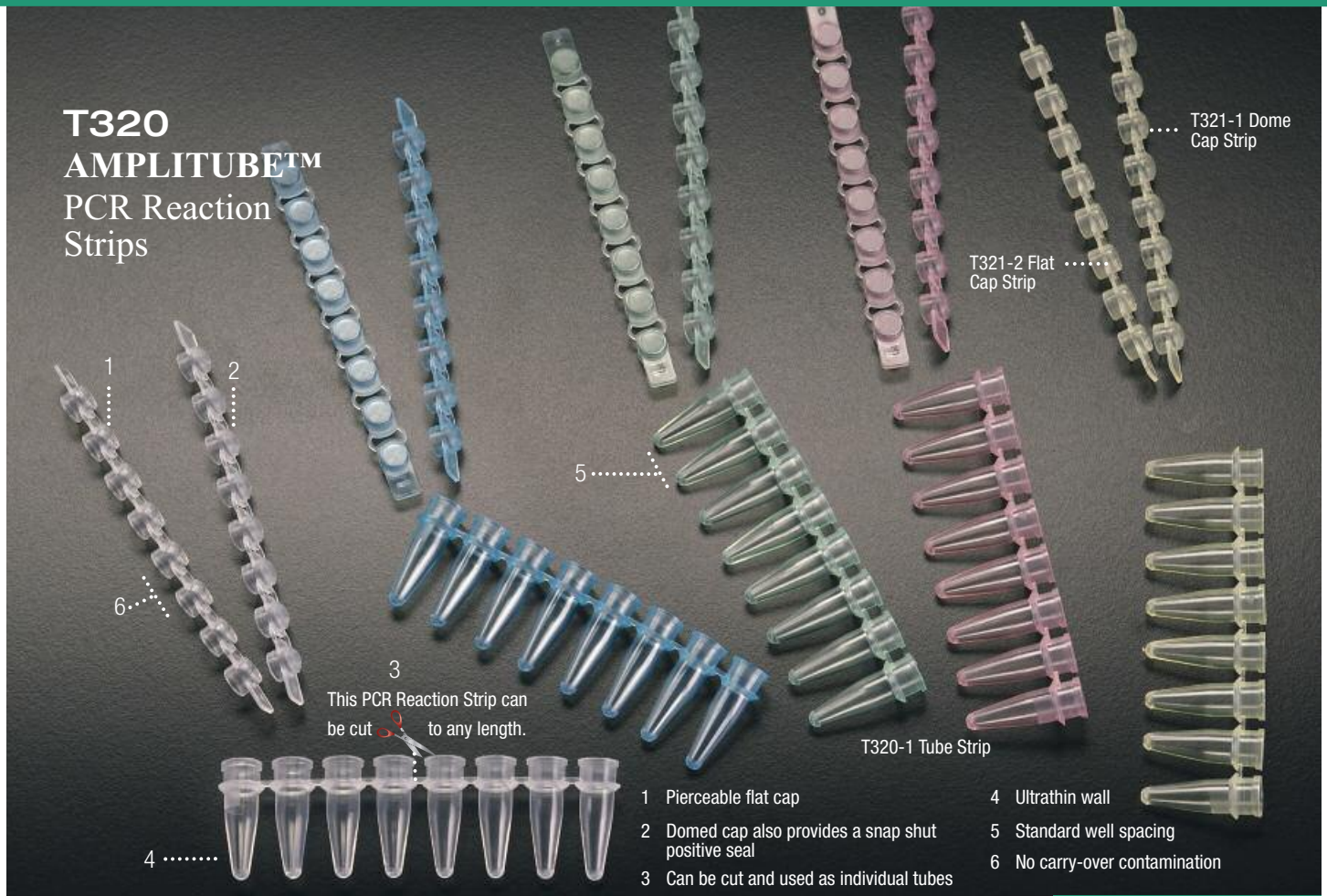

Made of polypropylene

Simport® Reaction Strips include 8 or 12 integral 0.2 ml tubes with ultrathin sidewalls and bottoms for more uniform and efficient temperature transfer, therefore reducing PCR reaction time in most 96-well "V" bottomed thermal cyclers such as MJ Research, Perkin Elmer, Hybaid and others.

They are more easily handled than single tubes. They will precisely fit standard well spacing and can also be used with 8- and 12-channel hand-held pipettors. All strips are molded of polypropylene under the most stringent conditions and are offered, colorless and in four different colors.

Non-attached cap strips are available in a dome or flat top design and ensure a perfect closure during the whole thermal cycle. Cap strips are not included and have to be ordered separately (see T321 Series). Packed in tamperproof resealable bags.

Tubes on this page are certified  
RNase, DNase,  
Pyrogen and DNA-free

### TUBE & CAP STRIPS OF 8

Cat. # Tube Strip	Cat. # Domed Cap	Cat. # Flat Cap	Color	Qty/Pk
T320-1N	T321-1N	T321-2N	Natural	125
T320-1B	T321-1B	T321-2B	Blue	125
T320-1G	T321-1G	T321-2G	Green	125
T320-1R	T321-1R	T321-2R	Red	125
T320-1Y	T321-1Y	T321-2Y	Yellow	125

### TUBE & CAP STRIPS OF 12

Cat. # Tube Strip	Cat. # Domed Cap	Color	Qty/Pk
T320-10N	T321-3N	Natural	125
T320-10B*	—	Blue	125
T320-10G*	—	Green	125
T320-10R*	—	Red	125
T320-10Y*	—	Yellow	125

\* Available on request only. Minimum quantities apply. Please enquire for more details.

All flat cap strips  
T321-2 have a super clear highly polished upper surface for real time qPCR applications on

Natural flat cap strips in series T321-2 have a super clear highly polished upper surface for real time qPCR applications and fluorescence detection.

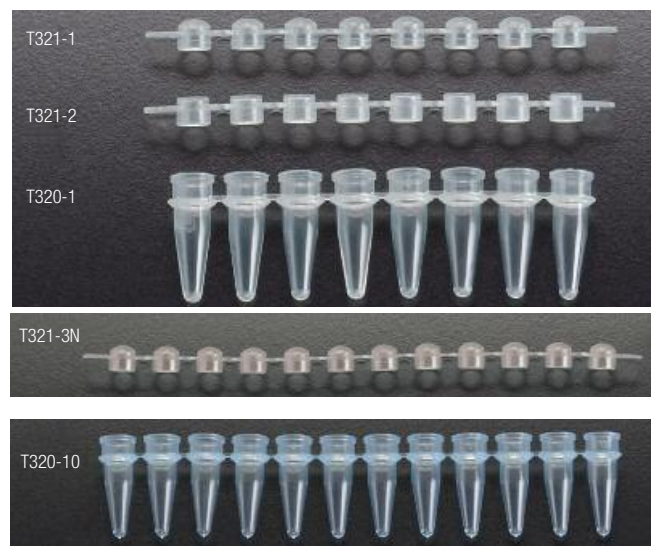



# Simport® Most Popular Tube Strips

## T320-2 & -3 AMPLITUBE™ PCR Reaction Strips

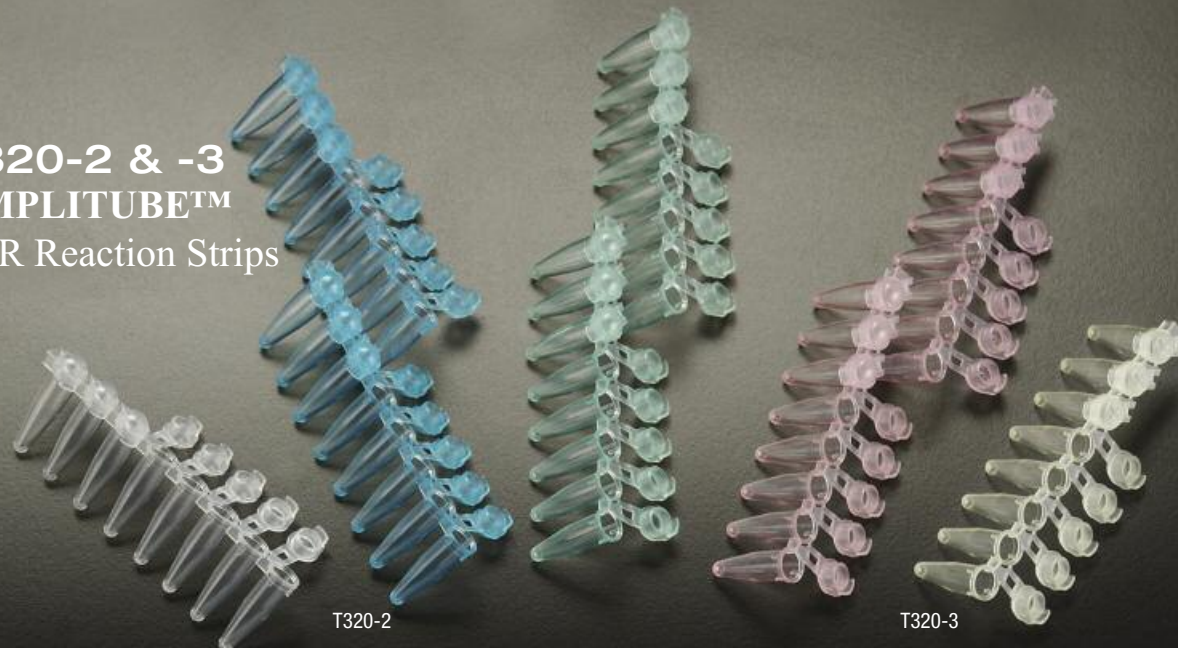

This PCR reaction strip is available with either flat (needle pierceable) or dome-topped individually attached hinged caps.



The cap has an integral seal preventing contamination with surface of lid.

Made of polypropylene

This more convenient 0.2 ml tube strip incorporates individually attached caps. No need to carry two separate components in inventory. The strip includes 8 integral 0.2 ml tubes with ultrathin sidewalls and bottoms for more uniform and efficient temperature transfer.

This PCR reaction strip is available with either flat (needle pierceable) or dome-topped individually attached hinged caps. While easily opened and closed with one hand, their positive sealing will fully protect the contents from evaporation during the whole thermal cycle. The cap has an integral seal preventing contamination with surface of lid.

While more easily handled than single tubes, the strip will precisely fit standard well spacing and can also be used with 8-channel hand-held pipettors. Manufactured under the most stringent conditions to attain the highest quality standards in the industry. Choice of colorless and four non-cytotoxic and non-metallic colors. Packed in tamperproof resealable bags.

## T320-2LPN Low Profile AMPLITUBE™ PCR Reaction Strip

Made of polypropylene



Well volume is only 100 µl

This flat cap low profile model has a volume of only 100 µl per tube, for a total of 8 tubes.

Cat. #	Type of Cap	Color	Qty/Pk
T320-2LPN	Flat	Natural	125

Cat. #	Type of Cap	Cat. #	Type of Cap	Color	Qty/Pk
T320-2N	Flat	T320-3N	Domed	Natural	125
T320-2B	Flat	T320-3B	Domed	Blue	125
T320-2G	Flat	T320-3G	Domed	Green	125
T320-2R	Flat	T320-3R	Domed	Red	125
T320-2Y	Flat	T320-3Y	Domed	Yellow	125

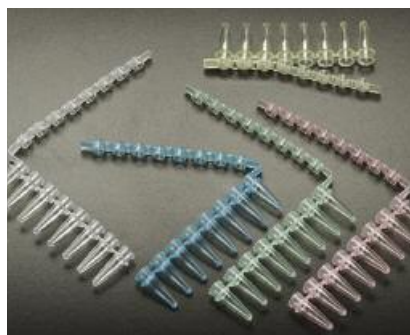

## T322 AMPLITUBE™ Thin Wall PCR Reaction Strips (Cap Strip attached)

Made of polypropylene

These reaction strips are identical to T320 Series but include already attached 8-cap strips molded with a living hinge to facilitate opening and closing. They are manufactured under strict quality control supervision to ensure reproducible results, using a special almost transparent polypropylene.

Individual tube sealing ensures that samples are well protected from any carry-over contamination. The domed cap design offers a snap shut seal to avoid evaporation during thermal cycling stages. Packed in tamperproof resealable bags.

Cat. #	Color	Qty/Pk
T322-1N	Natural	125
T322-1B	Blue	125
T322-1G	Green	125
T322-1R	Red	125
T322-1Y	Yellow	125

Strips on this page are certified  
RNase, DNase,  
Pyrogen and DNA-free

# T323 AMPLATE™ Thin Wall PCR Plates

Made of polypropylene

- Alphanumeric grid for better identification
- Flexible plate for better fitting of tubes in thermal block
- Can be cut to desired format
- Corner is cut away to facilitate orientation of plate
- Inside of tube is smooth and has an inert surface

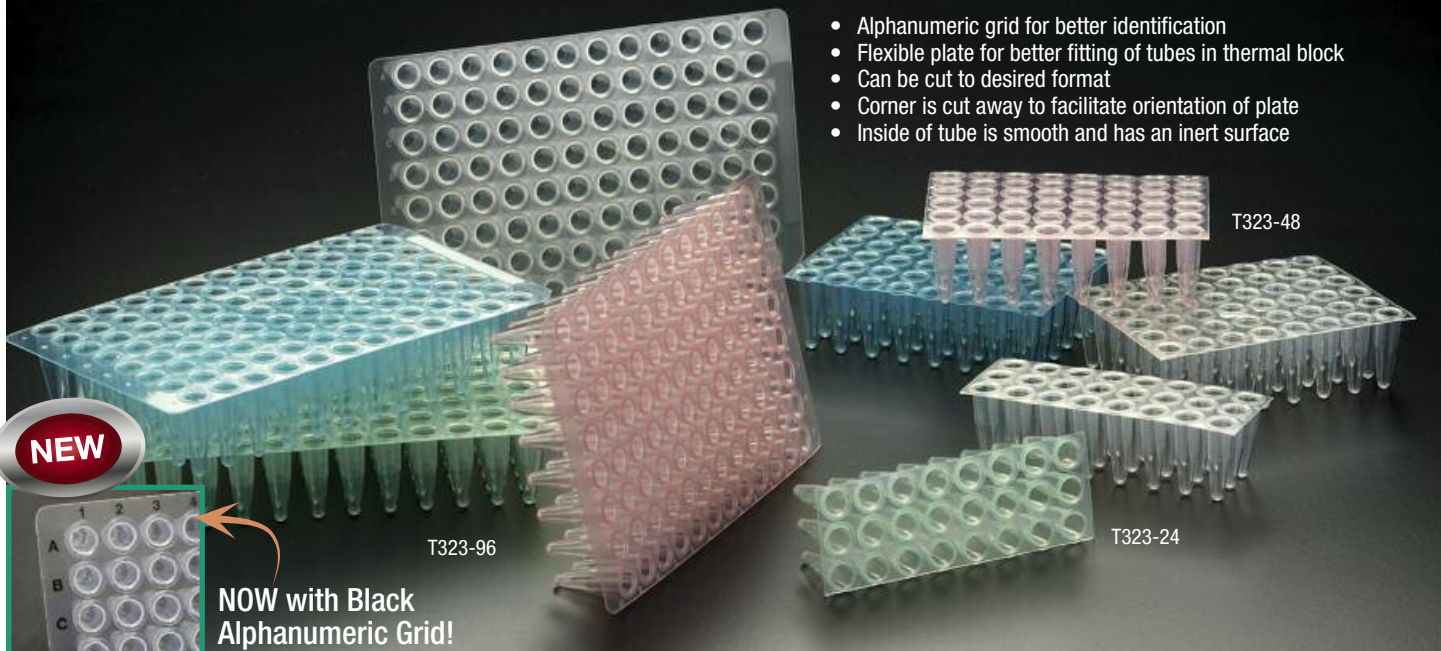

These 96-well PCR plates are thin-walled and designed for rapid thermal transfer. Each well has a capacity of 0.2 ml. They are precision-molded to ensure well-to-well and plate-to-plate uniformity. The insides of the tubes are smooth and have an inert surface on which enzymes and nucleic acids do not bind.

All sealing methods can be used for oil-free operation:

SecureSeal™ Thermal sealing film and foil (T329 Series), and Amplate™ Mat (T329-10). Suitable to be used with all 96-well shaped cyclers. Their flexible design allows them to be easily cut into sections of 24, 32 or 48 tubes.

The plates will accommodate differences in expansion coefficients between the metal thermal cycler block and polypropylene tubes. For more convenience, pre-cut plates are also available in the following formats: 48 tubes (6 x 8) and 24 tubes (3 x 8).

On the 96-well plate, a printed black alphanumeric grid helps sample identification. To facilitate orientation, the bottom right corner of the plate is cut away. The AMPLATE™ is easy to seal since no cylindrical walls extend above the plate. More economical than using single tubes, it is available colorless and in four different colors. Packed in tamperproof resealable bags of 10 plates.

Plates on this page are certified  
RNase, DNase,  
Pyrogen and DNA-free

NOW with Black  
Alphanumeric Grid!

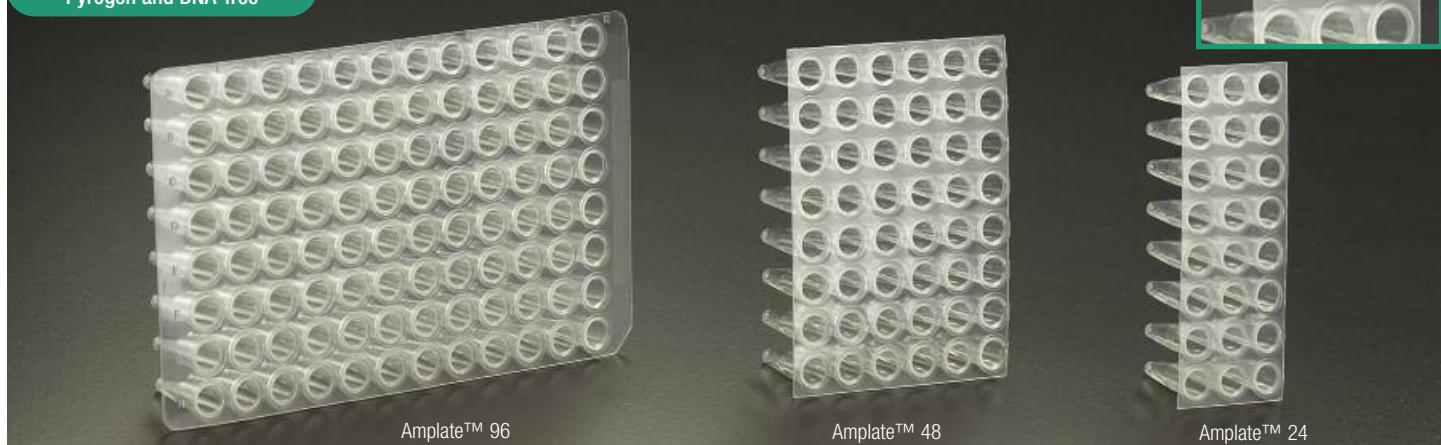
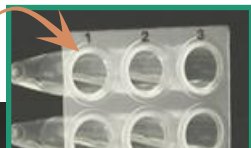

Amplate™ 96				Amplate™ 48		Amplate™ 24		
Cat. #	Color	Qty/Bag	Qty/Cs	Cat. #	Cat. #	Color	Qty/Bag	Qty/Cs
T323-96N	Natural	10	100	T323-48N	T323-24N	Natural	10	50
T323-96B	Blue	10	100	T323-48B	T323-24B	Blue	10	50
T323-96G	Green	10	100	T323-48G	T323-24G	Green	10	50
T323-96R	Red	10	100	T323-48R	T323-24R	Red	10	50
T323-96Y	Yellow	10	100	T323-48Y	T323-24Y	Yellow	10	50

## T323-96LP

### Low Profile AMPLATE™ 96

### Thin Wall PCR Plates

Made of polypropylene

These low profile 96-well PCR plates are similar to the regular Simport® AMPLATE™ Series detailed on the previous page. However, each of the 96 tubes has a smaller volume (only 100 µl) and thereby reduce the dead space between sample and cover.

They are thin-walled and designed for rapid thermal transfer. precision-molded to ensure well-to-well and plate-to-plate uniformity. All sealing methods can be used for oil-free operation: domed and flat cap strips (T321 Series), SecureSeal™ Thermal sealing film and foil (T329 Series), and Amplate™ Mat (T329-10). Suitable to be used with all 96-well shaped cyclers.

The flexible design accommodates differences in expansion coefficients between the metal thermal cycler block and polypropylene tubes.

A printed black alphanumeric grid helps sample identification. To facilitate orientation, corner at A1 of the plate is cut away. The AMPLATE™ is easy to seal since no cylindrical walls extend above the plate. More economical than using single tubes, it is available colorless and in four different colors.

Packed in tamperproof resealable bags of 10 plates.

**CAN BE USED WITH ALL LEADING THERMAL CYCLERS**

Plates on this page are certified  
RNase, DNase,  
Pyrogen and DNA-free



- Alphanumeric grid for better identification
- Flat surface for better sealing
- Small volume reducing dead space between sample and cover

Cat. #	Color	Qty/Bag	Qty/Cs
T323-96LPN	Natural	10	100
T323-96LPB*	Blue	10	100
T323-96LPG*	Green	10	100
T323-96LPR*	Red	10	100
T323-96LPY*	Yellow	10	100

\* Minimum quantity applicable. Please contact one of our customer service agents for further details.

## T323-96SK

### Skirted AMPLATE™ 96

### Thin Wall PCR Plates

Made of polypropylene

Similar to the T323 Series above, these skirted 96-well PCR plates are thin-walled and designed for rapid thermal transfer. The skirt around the plate provides a bar coding and labeling area, unavailable in other types of plates. They are precision-molded to ensure well-to-well and plate-to-plate uniformity. Quite superior to polycarbonate plates, they are impermeable to water vapor.

All sealing methods can be used for oil-free operation: domed and flat cap strips (T321 Series), SecureSeal™ Thermal sealing film and foil (T329), and Amplate™ Mat (T329-10 Series). Suitable to be used with all 96-well shaped cyclers.

An alphanumeric grid helps sample identification. To facilitate orientation, corner at H1 of the plate is cut away. The AMPLATE™ is easy to seal since no cylindrical walls extend above the plate. More economical than using single tubes, it is available colorless and in four different colors.

Finally, the Simport® AMPLATE™ can be handled by robotic handling equipment and is ideal with automated pipetting systems.

Packed in tamperproof resealable bags of 10 plates.



- Alphanumeric grid for better identification
- Flat surface for better sealing
- Can be handled by robotic handling equipment
- Area for bar coding, labeling or writing on each side and top
- Each well has a volume of 100 µl

Cat. #	Color	Qty/Bag	Qty/Cs
T323-96SKN	Natural	10	100
T323-96SKB*	Blue	10	100
T323-96SKG*	Green	10	100
T323-96SKR*	Red	10	100
T323-96SKY*	Yellow	10	100

\* Minimum quantity applicable. Please contact one of our customer service agents for further details.

# AMPLATE™ Raised Rim Thin Wall PCR Plates

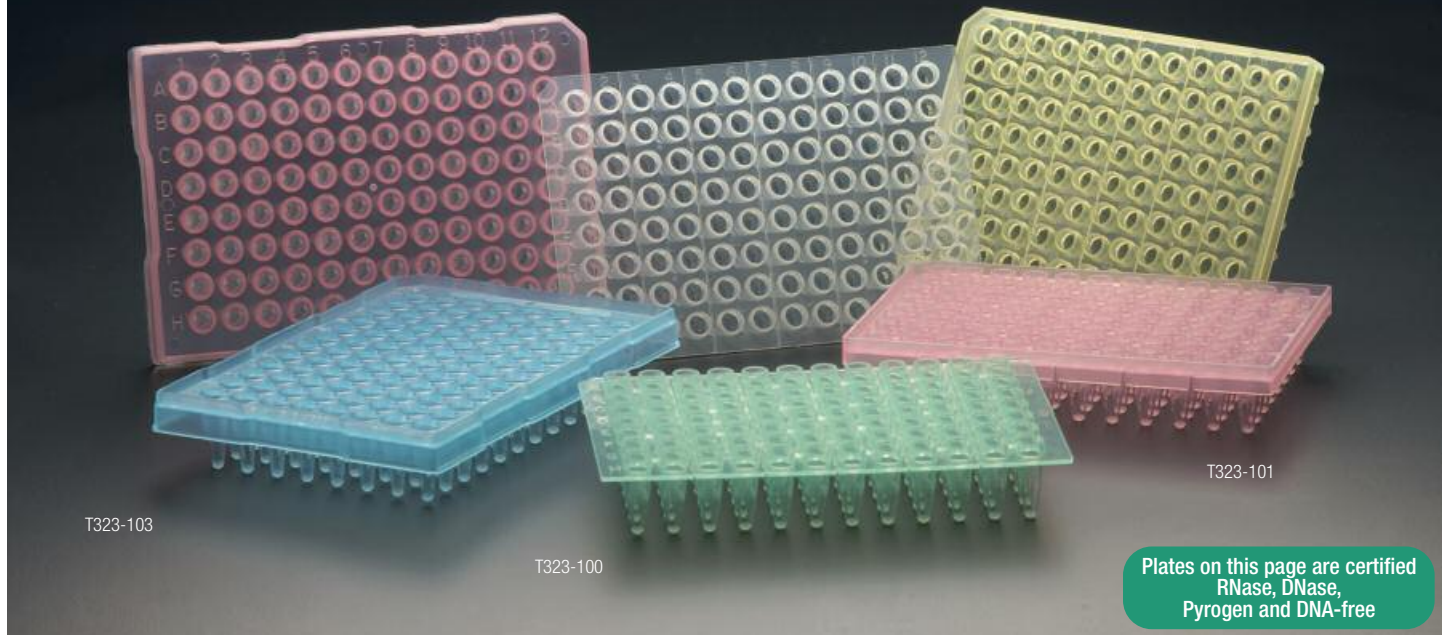

Plates on this page are certified RNase, DNase, Pyrogen and DNA-free

Made of polypropylene

Amplate™ Raised Rim thin wall PCR plates are the latest addition to the wide range of Simport® PCR products. Offering just the right rigidity for automation, these four 96-well plates, made in a standard 8 x 12 configuration, are perfectly suited for high performance thermal cycling. Each well makes intimate contact with the heating block while quick and consistent heat transfer is ensured by a uniform wall thickness. Using a special polypropylene, samples are easily recovered thanks to a low adhesion surface.

Well capacity: T323-100 and -101 Series: 250 µl, T323-103 Series: 200 µl, T323-104: 100 µL.

These plates offer the right alternative to existing Robbins (-100), Corning (-101), Perkin Elmer (-103) and ABI (-104) models. T323-100 and -101 Series have a 3 mm raised rim around each tube well.

T323-101 is supplied with a wide skirt extending over and under the plate on which a bar code can be affixed to facilitate identification. T323-103 and T323-104 will also offer the same skirt but the rim above each tube well is only 1 mm high.

All sealing methods can be used for oil-free operation: domed and flat cap strips (T321 Series); SecureSeal™ Thermal Sealing Film (T329-1); SecureSeal™ Aluminium Sealing Foil (T329-5) and Amplate™ Mat (T329-10). To facilitate orientation, one corner of the plate is cut away. An alphanumeric grid helps sample identification. Packed in tamperproof resealable bags of ten plates.



Cat. #	Color	Qty/Bag	Qty/Cs
T323-100N	Natural	10	100
T323-100B*	Blue	10	100
T323-100G*	Green	10	100
T323-100R*	Red	10	100
T323-100Y*	Yellow	10	100

Cat. #	Color	Qty/Bag	Qty/Cs
T323-101N	Natural	10	100
T323-101B*	Blue	10	100
T323-101G*	Green	10	100
T323-101R*	Red	10	100
T323-101Y*	Yellow	10	100

Cat. #	Color	Qty/Bag	Qty/Cs
T323-103N	Natural	10	100
T323-103B*	Blue	10	100
T323-103G*	Green	10	100
T323-103R*	Red	10	100
T323-103Y*	Yellow	10	100

\*Minimum quantity applicable. Please contact one of our customer service agents for further details.

Cat. #	Color	Qty/Bag	Qty/Cs
T323-104N	Natural	10	100

## T323-104N

### Semi Skirted AMPLATE™ Thin Wall PCR Plate

This plate is a perfect alternative to the Applied Biosystems MicroAmp® Fast 96-Well Reaction Plate, 0.1 ml, reducing PCR reaction time from 2 hours to as little as 25 minutes.



## T323-384SK AMPLATE™ 384 Thin Wall PCR Plates

Made of polypropylene

This plate has been developed for high volume laboratory work. It is precision-molded to ensure well-to-well and plate-to-plate uniformity.

The design of the AMPLATE™ 384 is such that each well having a 40 µl capacity can be used with reaction volumes from 2 to 30 µl. All wells on the plate are thin-walled to make sure that an efficient and fast heat transfer is occurring.

Although it has 384 wells, it can be filled using automated fluid handling systems or standard multichannel pipettors.

In order to offer more surface contact between the plate and the sealing medium, such as thermal foil and adhesive sealing films, there are no cylindrical walls extending above the plate.

The AMPLATE™ 384 is skirted to allow bar coding on sides for identification and also to make it compatible with automated fluid handling systems. Holes on sides allow for precise and accurate plate positioning and removal.

An alphanumeric grid helps in locating the sample. Two corners of the plate are cut away to facilitate orientation.

The AMPLATE™ 384 is definitely more economical than using single tubes, strips, and even 96-well plates. It is available colorless and in four popular colors. Packed in tamperproof resealable bags of 10 plates.

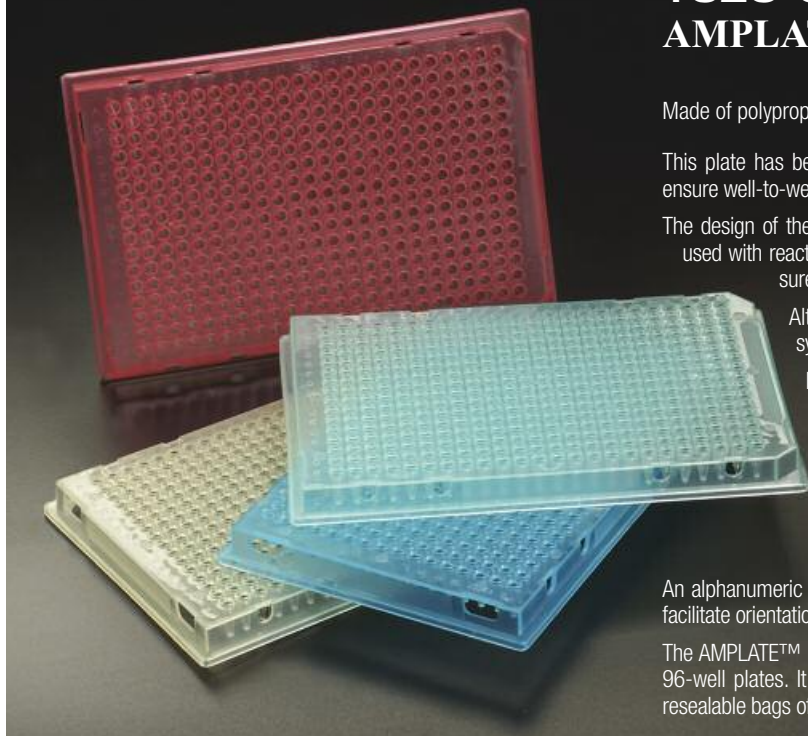

Cat. #	Color	Qty/Bag	Qty/Cs
T323-384SKN	Natural	10	100
T323-384SKB*	Blue	10	100
T323-384SKG*	Green	10	100
T323-384SKR*	Red	10	100
T323-384SKY*	Yellow	10	100

\*Minimum quantity applicable. Please contact one of our customer service agents for further details.



Plates on this page are certified  
RNase, DNase,  
Pyrogen and DNA-free

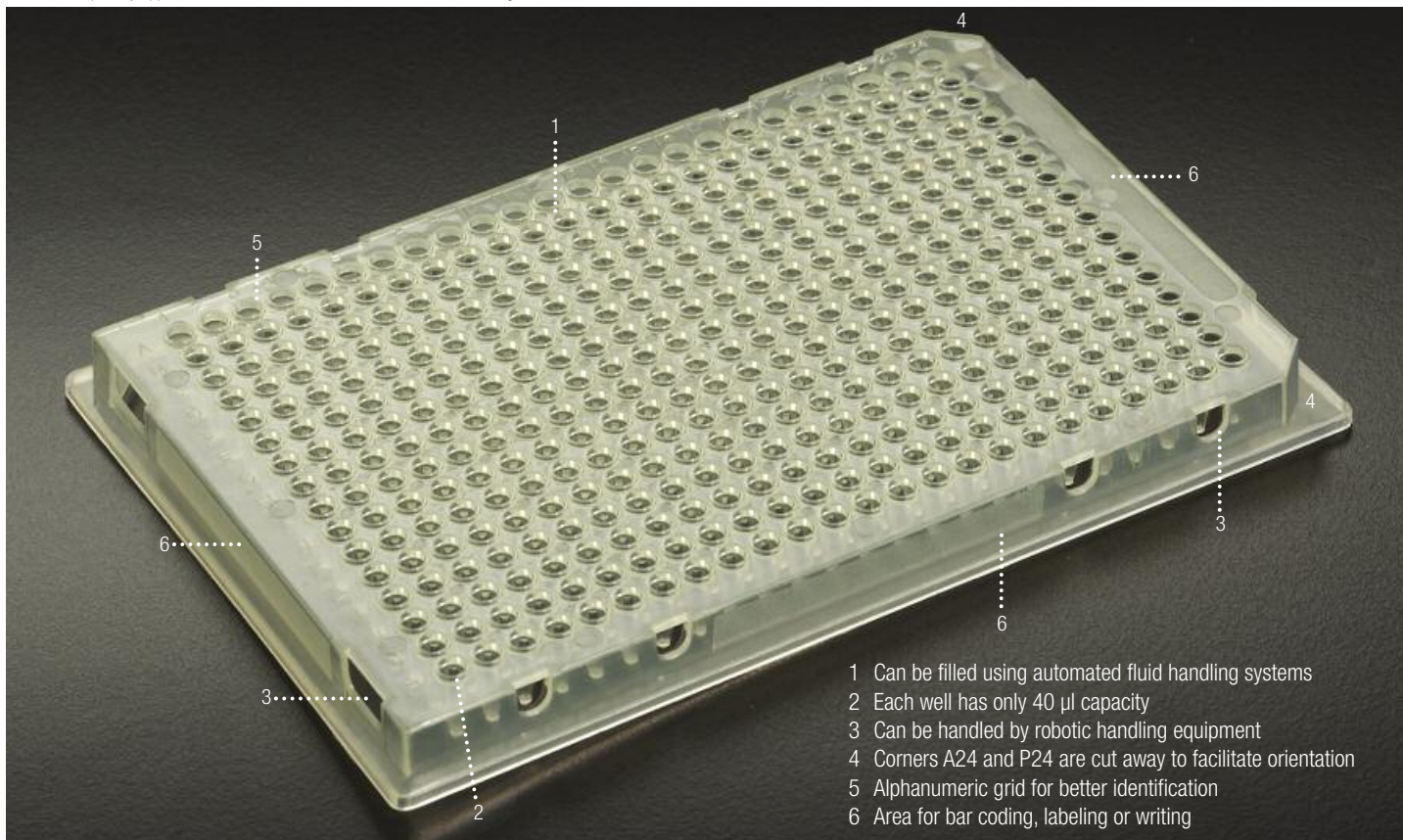

- 1 Can be filled using automated fluid handling systems
- 2 Each well has only 40 µl capacity
- 3 Can be handled by robotic handling equipment
- 4 Corners A24 and P24 are cut away to facilitate orientation
- 5 Alphanumeric grid for better identification
- 6 Area for bar coding, labeling or writing



Well volume is only 100 µl

- 1 Alphanumeric grid for better identification
- 2 Area for bar coding, labeling or writing
- 3 Can be handled by robotic handling equipment
- 4 One corner is cut away to facilitate orientation
- 5 Flat surface of wells for better sealing
- 6 Opaque to ensure low level of background fluorescence

Plates on this page are certified  
RNase, DNase,  
Pyrogen and DNA-free

## T324-96SK

### Opaque Skirted AMPLATE™ 96 Thin Wall PCR Plates

Made of polypropylene

These opaque 96-well PCR plates are for chemiluminescent and fluorescent procedures. Each well has a capacity of 100 µl. Thin-walled and designed for rapid thermal transfer. They are precision-molded to ensure well-to-well and plate-to-plate uniformity.

All sealing methods can be used for oil-free operation: domed and flat cap strips (T321 Series), SecureSeal™ Thermal and foil (T329 Series), and Amplate™ Mat (T329-10). Suitable to be used with all 96-well shaped cyclers.

An alphanumeric grid helps in sample identification. To facilitate orientation, corner at H1 of the plate is cut away. The AMPLATE™ is easy to seal since no cylindrical walls extend above the plate. Finally, the Simport® AMPLATE™ can be handled by robotic handling equipment and is ideal with automated pipetting systems.

Packed in tamperproof resealable bags of 10 plates.



Cat. #	Color	Qty/Bag	Qty/Cs
T324-96SKK	Black	10	100
T324-96SKW	White	10	100

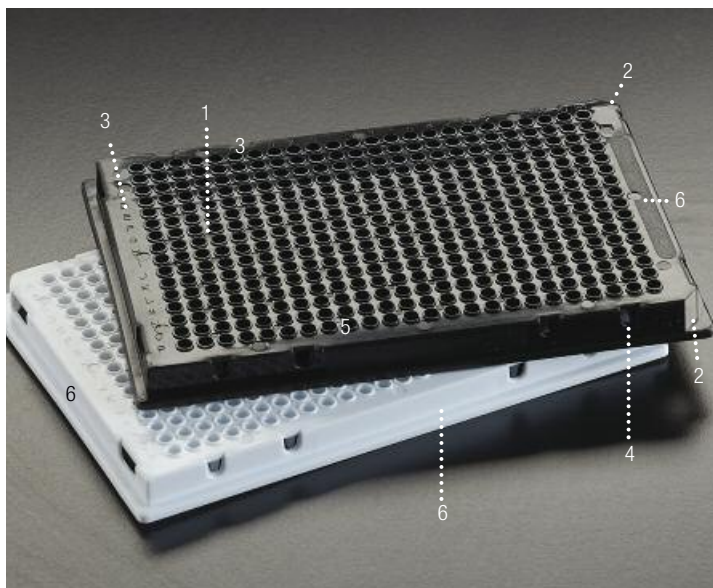

- 1 Can be filled using automated fluid handling systems
- 2 Two corners are cut away to facilitate orientation
- 3 Alphanumeric grid for better identification
- 4 Can be handled by robotic handling equipment
- 5 Opaque to ensure low level of background fluorescence
- 6 Area for bar coding, labeling or writing



## T324-384SK

### Opaque Skirted AMPLATE™ 384 Thin Wall PCR Plates

Made of polypropylene

For chemiluminescent and fluorescent procedures, the AMPLATE™ -384 is available in opaque white or black. The white plate will increase signal output in both types of assays. It has been developed for high volume laboratory work. It is precision-molded to ensure well-to-well and plate-to-plate uniformity.

The design of the AMPLATE™ -384 is such that each well having a 40 µl capacity can be used with reaction volumes from 2 to 30 µl capacity. Only virgin polypropylene is used to manufacture this plate. Although it has 384 wells, it can be filled using automated fluid handling systems or standard multichannel pipettors. All wells on the plate are thin-walled to make sure that an efficient and fast heat transfer is occurring.

In order to offer more surface contact between the plate and the sealing medium, such as thermal foil and adhesive sealing films, there are no cylindrical walls extending above the plate.

The AMPLATE™ -384 is skirted to allow bar coding on sides for identification and also to make it compatible with automated fluid handling systems. Holes on sides allow for precise and accurate plate positioning and removal.

An alphanumeric grid helps in locating the sample. Two corners of the plate are cut away to facilitate orientation.

Packed in tamperproof resealable bags of 10 plates.

Cat. #	Color	Qty/Bag	Qty/Cs
T324-384SKK	Black	10	100
T324-384SKW	White	10	100

## T319-4N

### RotoCycler™ 0.1 ml Tube and Cap Strips for Qiagen Rotor-Gene™ Q Real-Time Rotary Analyzer

Made of polypropylene

The Rotor-Gene™ analyzer was formerly designed by Corbett. These RotoCycler™ strips are perfectly designed to perform on Rotor-Gene™ instruments. Tube strips are packaged separately from cap strips. The frosted extensions on caps not only make them more efficient and secure during handling but also offer a convenient area for labelling. For individual use, tube and cap strips can easily be separated and used as individual units. Each package contains four bags of 250 tube strips and four bags of 250 cap strips. Case content is sufficient for 4000 reactions.

Cat. #	Description	Qty/Pk	Qty/Cs
T319-4N	Tube and Cap Strips, 0.1 ml	250	1000



## T319-72D2 and -100D1

### RotoCycler™ Discs for Qiagen Rotor-Gene™ Q Real-Time Rotary Analyzer

Made of polypropylene

The RotoCycler™ Discs are specially made to be used with the Qiagen Rotor-Gene™ Q Real-Time Rotary Analyzer. Two models are available: a 72-well format with 100 µL tubes and a 100-well format for reactions up to 25 µL. The discs are a one-piece "plate" equivalent, having vertically oriented wells compatible with automated reaction setup using a robotic liquid handling system.

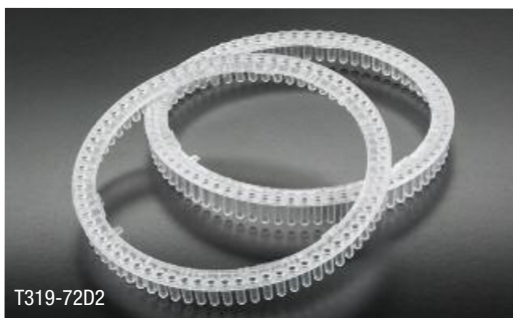

T319-72D2

Case content is sufficient for 1728 reactions.

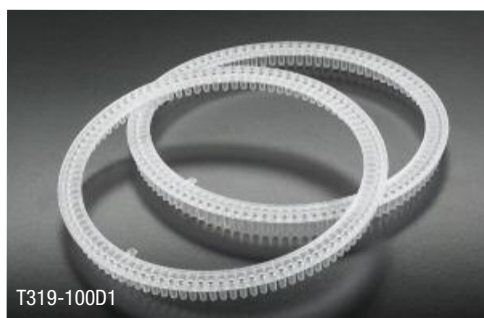

T319-100D1

Case content is sufficient for 3000 reactions.

Consumables on this page are certified RNase, DNase, Pyrogen and DNA-free

Cat. #	Description	Qty/Bag
T319-72D2	RotoCycler™ 72 Rotor with 100 µL wells	24
T319-100D1	RotoCycler™ 100 Rotor with 25 µL wells	30

## T319-4WS1

### RotoCycler™ 72 Workstation

Made of aluminum

In order to facilitate the handling and insertion of caps on the tubes, Simport® offers a special solid aluminum loading rack. This rack can hold up to 18 x 0.1 ml tube strips for a total of 72 tubes. Other cavities can hold larger reaction tubes. To keep reactions cool during setup, simply place the rack in a refrigerated area. For easy reference, all wells are numbered. Color coding is made possible by inserting a Capinsert™ in up to two locations on the rack. Five hundred color coding inserts of assorted colors are enclosed.

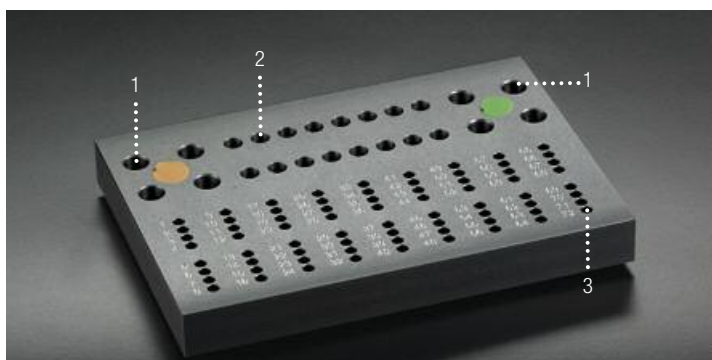

1. For 0.5 ml tubes T325-3 and T325-4.
2. For 0.2 ml tubes T325-1, T325-2 and T325-12.
3. For tube strips T319-4N.

Cat. #	Description	Qty/Box
T319-4WS1	RotoCycler™ 72 Workstation	1

Color coding possible using a Simport® Capinsert. Ten colors available. See page 128 for more details.



## T327 COMBI-BOX™

Made of pvc

The Simport® Combi-Box™ can be used not only as a storage rack but also as a workstation. The white base will accept all 96- and 384-well plates and an easy to remove transparent cover allows easy viewing of contents. Being only 40 mm high, the stackable Combi-Box™ saves space on the lab bench and on refrigerator or freezer shelves. For single tubes as well as strips, use the Combi-Rack™ (T327-1) which can hold up to 96 tubes or 12 strips of 8.

Cat. #	Color	Qty/Cs
T327	White base	5

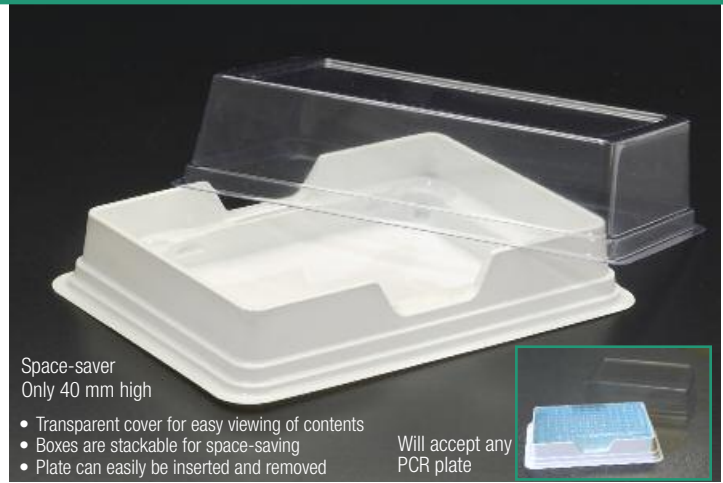

Space-saver  
Only 40 mm high

- Transparent cover for easy viewing of contents
- Boxes are stackable for space-saving
- Plate can easily be inserted and removed

Will accept any  
PCR plate

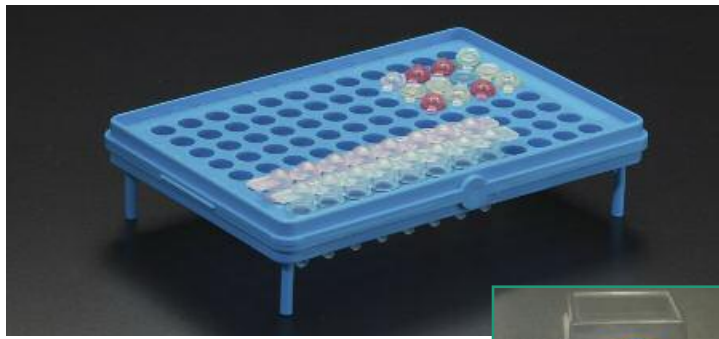

- Plate can easily be inserted and removed
- Alphanumeric identification of each position
- Can accept single tubes, strips and plates up to 96 wells
- Stackable



## T327-1 COMBI-RACK™

Made of polypropylene

The Simport® Combi-Rack™ is an innovative support that can hold up to 96 PCR tubes or 12 strips of 8 tubes with caps. Each hole is identified with an alphanumeric numbering system for identifying tubes. The grid stands on 4 legs and can be placed on a lab counter or in a refrigerator or freezer shelf. Made of polypropylene, it can easily withstand temperatures from -80 °C to +121 °C. It is also ideal for carrying and storing, freezing and transporting reagents and specimens.

For storage, simply place the Combi-Rack™ in the T327 Combi-Box™ and place cover.

Cat. #	Color	Qty/Cs
T327-1	Blue	5

## T328-96 PCRRack™

Made of polypropylene

This convenient space saving rack was designed especially for storing and working with PCR samples. The PCRRack™ will accept all models of 0.2 ml tubes, along with strips of 8 or 12 tubes. 96-well PCR plates can also be accommodated.

The PCRRack™ can be horizontally attached to each other in order to build-up any configuration you desire. With the cover on, they are easily stackable one on top of another. Thanks to these special features, efficiency is highly improved allowing you to carry a multitude of tubes and/or strips at the same time.

Cat. #	Color	Qty/Cs	Cat. #	Color	Qty/Cs
T328-96B	Blue	20	T328-96R	Red	20
T328-96G	Green	20	T328-96Y	Yellow	20
T328-96O	Orange	20	T328-96AS	Assorted*	20
T328-96P	PinK	20	*Blue, green, orange, pink, yellow.		



## S500-80 UniRack™

Made of polypropylene

The UniRack™ offers the laboratory a support far more versatile and easy to use than any other rack available today. It is designed to use minimum counter space while offering maximum flexibility. Made of polypropylene, it allows great resistance to various chemicals used in laboratories. For further information, see page 142.

Cat. #	Color	Qty/Cs	Cat. #	Color	Qty/Cs
S500-80B	Blue	10	S500-80R	Red	10
S500-80G	Green	10	S500-80Y	Yellow	10
S500-80O	Orange	10	S500-80AS	Assorted*	10
S500-80P	PinK	10	Lid Cat. #	Color	Qty/Cs
			S501-80	Transparent	10

\*Blue, green, orange, pink, yellow.



Will accept individual 200 µl and 500 µl PCR Tubes



## T329-1 & -2 SecureSeal™ Thermal Adhesive Sealing Film for PCR application

This transparent sealing tape consists of a 2.0 mil polyolefin film coated on one side with a pressure sensitive acrylate adhesive which does not interfere with cycle reactions. It is ideal for reducing well-to-well contamination and/or spill over in sensitive PCR applications where the minimization of evaporation and vapor loss is critical.

SecureSeal™ Thermal Film was developed with the assistance of a major cycler manufacturer for PCR applications. Not only does it offer low-autofluorescence but it will prevent vapor loss and is thermostable and functional from -70 °C to +100 °C. Certified RNase, DNase and DNA-free. DMSO resistant.

**Note:** Performance may depend upon the specific collection/sample vessel used as well as the specific conditions to which it is subjected.

Cat. #	Color	Sterile	Qty/Pk	Qty/Ca
T329-1	Transparent	No	100	1000
T329-2	Transparent	Yes	100	1000

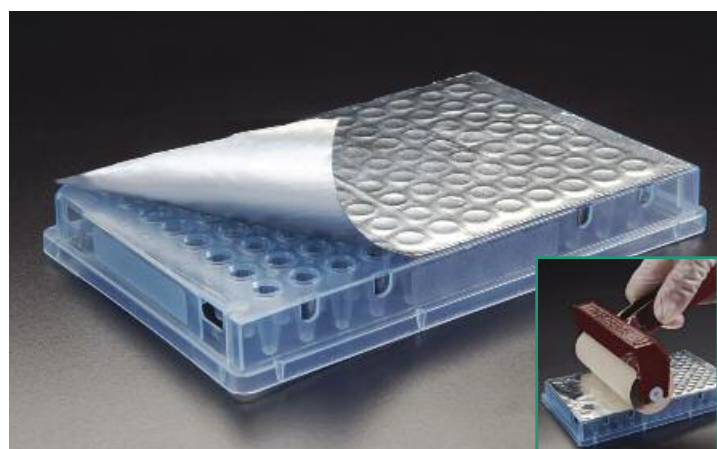
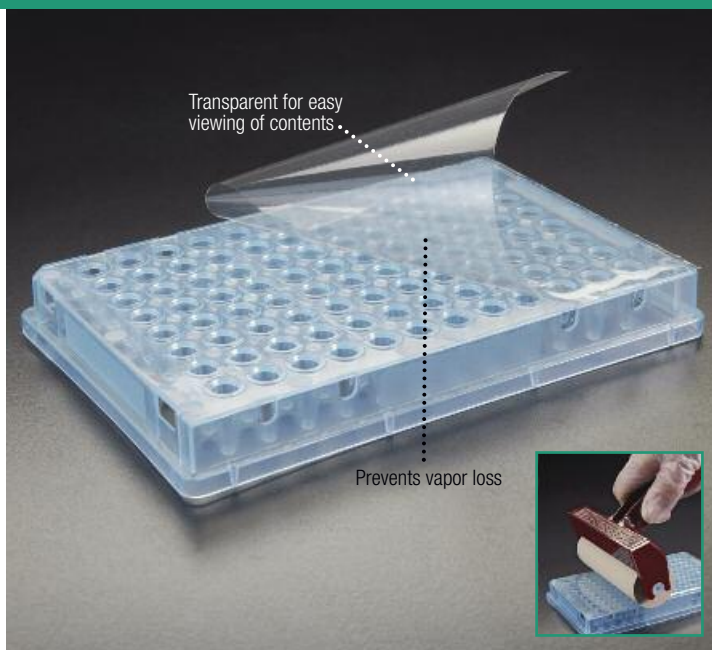

## T329-5 SecureSeal™ Aluminum Sealing Foil

This type of material is ideal for manual sealing during PCR work and also for high throughput applications. Adhesive backing makes it easy to apply. Will resist temperatures from -80 °C to +120 °C. It is recommended to use the Amplate™ Roller (T329-9) to ensure a perfect bond, eliminating the dangers of evaporation. Pierceable with a pipet tip for easy access to sample. Certified RNase, DNase and DNA-free. DMSO resistant.

Cat. #	Description	Qty/Pk
T329-5	Peeling foil	100 sheets

## T329-9 AMPLATE™ Roller

For ensuring a perfect seal when using either SecureSeal™ Thermal sealing film or foil on PCR plates. Roller made of medium hard rubber. Heavy-duty handle with comfort grip reducing fatigue. Will last a long time.



Cat. #	Size	Qty/Pk
T329-9	10.16 cm (4 in.)	1

## T329-10 AMPLATE™ Mat

Made of TPE



This flexible sealing cover is used on 96-well plates along with clip down and screw top thermal cyclers and has been proven to be a secure and effective way of sealing. Since it is reusable, it is a nice way to make this step of the procedure cost effective. Dimples on one side of the mat ensure it is well placed over the tubes. Can be used in temperatures ranging from -20 °C to +121 °C.

Cat. #	Color	Qty/Pk
T329-10	Blue	5

## T329-6 SecureSeal™ Thermal Adhesive Sealing Film for Real Time qPCR Application

With the highest transparency, this polyolefin film offers a special pressure sensitive DMSO-resistant silicone adhesive embedded inside the film itself. A polyester backing with end tabs assures easy positioning of the plate. This film is also perfectly suited for raised-rim plates ensuring reliable sealing around each well. Functional from -70 °C to +100 °C. Certified RNase, DNase and DNA-free.



Cat. #	Color	Sterile	Qty/Pk	Qty/Cs
T329-6	Transparent	No	100	1000

# PCR® THERMAL CYCLER GUIDE

Manufacturer	Application	T319 Series -4	T319 Series -72	T319 Series -100	T323 Series -96	T323 Series -96LP	T323 Series -96SK	T323 Series -100	T323 Series -101	T323 Series -103	T323 Series -104	T323 Series -384	T324 Series -96SK	T324 Series -384SK
Amersham														
MegaBACE™ 500	Sequencing						•						•	
MegaBACE™ 1000 mark II	Sequencing						•						•	
MegaBACE™ 4000	Sequencing													
Applied Biosystems (Life Technologies)														
Veriti® 0.1 ml 96-well Block	PCR										•			
Veriti® 0.2 ml 96-well Block	PCR									•				
GeneAmp® 2700/2720/9600	PCR				•			•		•				
GeneAmp® 9700	PCR				•					•			•	•
GeneAmp® 9800 Fast Block	PCR										•			
7000, 7300, 7500, 7700, 7900, ViiA7™	Real-Time PCR				•			•		•				
7500 Fast, 7900HT Fast 96-well block, ViiA7™	Real-Time PCR							•		•		•		
7900HT Standard 96-well Block, ViiA7™	Real-Time PCR									•				
7900HT 384 well block, ViiA7	Real-Time PCR											•		•
StepOne Plus™	Real-Time PCR										•			
3100 Genetic Analyser	Sequencing				•					•				
3130 Genetic Analyser	Sequencing				•					•				
310 Genetic Analyser	Sequencing				•					•				
3700 DNA Analyser	Sequencing				•					•				
3730/3730XL DNA Analyser	Sequencing				•					•				
Biometra														
Uno	PCR				•	•	•			•			•	
Uno II	PCR				•	•								
T1 Thermocycler	PCR				•	•	•			•		•	•	•
Tgradient	PCR				•	•	•			•			•	
Trobot	PCR				•	•	•			•			•	
TProfessional	PCR				•	•	•						•	
Bio-Rad/MJ														
iCycler® / MyCycler®	PCR				•					•				
C1000™, S1000™	PCR				•	•	•					•	•	•
PTC-2(XX)	PCR				•	•	•	•		•		•	•	•
PTC-100™ with 96-well block	PCR				•	•	•	•		•			•	
iCycler™	Real-Time PCR				•					•				
iq™4 / iq™5, MyiQ, MyiQ2	Real-Time PCR				•									
CFX96™	Real-Time PCR					•	•						•	
CFX384™	Real-Time PCR											•		•
Opticon™, Opticon 2™, Chromo4™	Real-Time PCR				•	•							•	
MiniOpticon™	Real-Time PCR				•								•	
BaseStation™	Sequencing						•							
Corbett Research														
Palm Cycler™	PCR					•	•							
Gene Technologies														
GS1/GS4/GSX	PCR					•	•					•		•
MWG														
Primus 96	PCR				•	•	•		•	•			•	
Primus 384	PCR											•		•
TheQ Lifecycler™	PCR				•	•	•			•			•	
Peqlab														
peqSTAR 96	PCR				•	•	•							
Qiagen														
Rotor-Gene Q		•	•	•										
SensoQuest														
LabCycler Basic 96	PCR				•	•	•			•			•	
LabCycler Gradient 96	PCR				•	•	•			•			•	
LabCycler 384	PCR											•		•
Stratagene (Agilent) and Eppendorf														
RoboCycler®	PCR				•									
Gradient Cycler	PCR				•	•	•			•			•	•
Mastercycler® Gradient	PCR				•	•	•	•		•			•	•
MasterCycler® EP Gradient/Pro	PCR				•	•	•	•		•			•	•
M384	PCR											•		•
Mx4000®	Real-Time PCR				•	•				•				
Mx3000P®, Mx3005P™	Real-Time PCR				•	•				•				
Mastercycler® ep realplex	Real-Time PCR				•	•	•	•		•			•	
Takara														
TP3000	PCR				•	•				•				
Techné														
Flexigene, TC-412, TC-4000	PCR				•	•	•			•		•	•	•
Genius, Touchgene, TC-512, TC-5000	PCR				•	•	•	•	•	•		•	•	•
TC-Plus	PCR				•	•	•	•		•		•	•	•
Quantica	Real-Time PCR				•									
Thermo Scientific														
PCR Express, Px2, PxE	PCR				•	•	•			•			•	•
MultiBlock System & MBS®	PCR				•	•	•			•			•	•
Touchdown	PCR				•	•	•			•			•	•
Omnigene	PCR				•	•	•		•	•			•	•
Omn-E	PCR				•	•	•			•			•	•
Transgenomic														
Wave	Sequencing						•						•	

## ClikLok™ Microcentrifuge Tube Family T330

### Microcentrifuge Tube

- Extra clarity for better visual inspection
- Boil-proof design
- Ultra rugged walls made for high speed centrifugation
- Unique ClickLok™ sealing mechanism
- Made of highest purity polypropylene

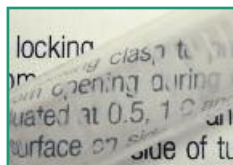

All microcentrifuge tubes have a super clear highly polished surface for better viewing of contents.

Made of polypropylene

These 0.6 ml and 1.5 ml graduated rugged tubes are made of laboratory grade polypropylene suitable to withstand the stress of high speed centrifugation up to 20,000g. The one-piece construction incorporates a snug fitting and reliable attached cap even with prolonged boiling. The bottom is reinforced for added protection against leakage. Maximum clarity for visual sample inspection. A frosted writing surface on closure and side of tube allows for easy and convenient sample identification. Highly polished interior ensures low liquid retention. Available in 4 colors. Packaged in tamperproof resealable safety-lock bags.

**Certified RNase, DNase,  
Pyrogen and DNA-free**



Cat. #	Color	Volume	Qty/Pk	Qty/Cs
T330-6N	Natural	0.6 ml	500	5000
T330-6B*	Blue	0.6 ml	500	5000
T330-6G*	Green	0.6 ml	500	5000
T330-6Y*	Yellow	0.6 ml	500	5000

\*Available on request only. Minimum quantities apply. Please enquire for more details.

Cat. #	Color	Volume	Qty/Pk	Qty/Cs
T330-7N	Natural	1.5 ml	500	5000
T330-7B	Blue	1.5 ml	500	5000
T330-7G	Green	1.5 ml	500	5000
T330-7Y	Yellow	1.5 ml	500	5000
T330-7AM	Amber	1.5 ml	500	5000



Conical bottom 2 ml microcentrifuge tubes

Cat. #	Color	Qty/Pk	Qty/Cs
T330-72N	Natural	500	5000
T330-72B*	Blue	500	5000
T330-72G*	Green	500	5000
T330-72Y*	Yellow	500	5000
T330-72AM*	Amber	500	5000

## T330-72, 72A

### 2 ml Microcentrifuge Tube

Made of polypropylene

These 2 ml microcentrifuge tubes offer a special design to produce a more secure closure. This will help to prevent tubes from opening during centrifugation, boiling, storing, freezing and shipping. They are graduated at 0.5, 1.0 and 1.5 ml. They are autoclavable to 121 °C. Pierceable lid. Etched surface on side of tube for sample identification. Large etched graduations make volumes easy to read. Improved polypropylene transparency for easy viewing of samples.

Tubes can withstand centrifugation up to 15,000g.

**Certified RNase, DNase,  
Pyrogen and DNA-free**

Self-standing conical bottom 2 ml microcentrifuge tubes

Cat. #	Color	Qty/Pk	Qty/Cs
T330-72AN	Natural	500	5000
T330-72AB*	Blue	500	5000
T330-72AG*	Green	500	5000
T330-72AY*	Yellow	500	5000
T330-72AAM*	Amber	500	5000

\*Available on request only. Minimum quantities apply. Please enquire for more details.



## T330-5N

### EconoTube™

Made of polypropylene

The least expensive microcentrifuge tube for all applications including storage and reactions. The one-piece construction incorporates a snug fitting and reliable attached cap. Not to be used for boiling applications.

Cat. #	Color	Volume	Qty/Pk	Qty/Cs
T330-5N	Natural	1.5 ml	500	5000

# MICROCENTRIFUGE TUBES



## T330LST

### Low Surface Tension Microcentrifuge Tubes

Made of polypropylene

The special type of plastic used provides these tubes with a low adhesion surface and optimum sample yield. No lubricant (such as silicone) is necessary, thereby eliminating the danger of sample contamination. It is also graduated and designed to withstand the stress of high speed centrifugation up to 20,000g. One-piece construction with snug fitting attached cap and reinforced tube bottom for added protection against leakage. Tubes are autoclavable to 121 °C. Packaged in tamperproof resealable safety-lock bags.

Cat. #	Color	Volume	Qty/Pk	Qty/Cs
T330-6LST	Natural	0.6 ml	500	5000
T330-7LST	Natural	1.5 ml	500	5000
T330-8LST	Natural	1.5 ml	500	5000
T330-72LST	Natural	2 ml	500	5000



Tubes on this page are certified  
RNase, DNase,  
Pyrogen and DNA-free

## T330-8

### Microcentrifuge Tube with Pick-Up Tab

Made of polypropylene

These tubes have all the fine features of the T330-7 series, but they also incorporate a convenient pick-up tabs for easier handling without actually touching the tube. Available in four different colors.

Cat. #	Color	Volume	Qty/Pk	Qty/Cs
T330-8N	Natural	1.5 ml	500	5000
T330-8B*	Blue	1.5 ml	500	5000
T330-8G*	Green	1.5 ml	500	5000
T330-8Y*	Yellow	1.5 ml	500	5000

\*Available on request only. Minimum quantities apply. Please enquire for more details.



## T330-15

### Microcentrifuge Tube with Locking Cap

Made of polypropylene

These Secure-Lock™ microcentrifuge tubes offer a special locking system which can be bent upward to lock on the cap, ensuring extra protection during critical steps such as boiling, freezing, centrifugation and shipping. Tubes are graduated at 0.5, 1.0 and 1.5 ml. Lids can be pierced easily with a syringe needle. Etched surface on side of tube for sample identification. Can be used at extreme temperatures from -175 °C to +121 °C. Autoclavable. Maximum centrifugation RCF: 20,000g. Packaged in tamperproof resealable safety-lock bags of 500 tubes.

Cat. #	Color	Qty/Pk	Qty/Cs
T330-15N	Natural	500	5000
T330-15B*	Blue	500	5000
T330-15G*	Green	500	5000
T330-15Y*	Yellow	500	5000

\*Available on request only. Minimum quantities apply. Please enquire for more details.

## Anatomy of a T330-15

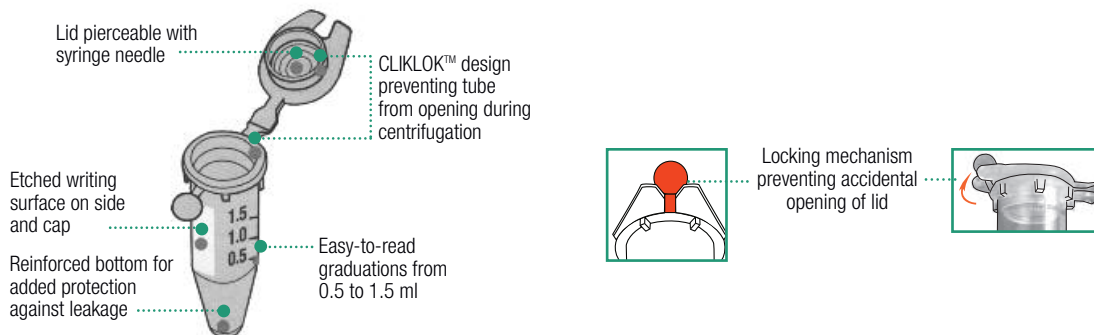

## T331-10

### Microcentrifuge Tube with SECURE-LOCK™

Made of polypropylene

These Secure-Lock™ microcentrifuge tubes offer a special locking clasp to produce a more secure closure. This will help to prevent tubes from opening during centrifugation, boiling, storing, freezing and shipping. They are graduated at 0.5, 1.0 and 1.5 ml. They are autoclavable to 121 °C. Pierceable lid. Etched surface on side of tube for sample identification.

Cat. #	Color	Qty/Pk	Qty/Cs
T331-10N	Natural	500	5000
T331-10B*	Blue	500	5000
T331-10G*	Green	500	5000
T331-10Y*	Yellow	500	5000

\*Available on request only. Minimum quantities apply. Please enquire for more details.



Tubes on this page are certified  
RNase, DNase,  
Pyrogen and DNA-free



## T331-20

### Microcentrifuge Tube with Pick-Up Tab and SECURE-LOCK™

Made of polypropylene

This tube is a combination of series T330-8 and T331-10 microcentrifuge tubes giving it the best of both: a pick-up tab for easier handling without actually touching the tube, and a Secure-Lock™ to help prevent tubes from opening during centrifugation, shipping, boiling or freezing. Graduated at 0.5, 1 and 1.5 ml. Autoclavable to 121 °C. Pierceable lid. Etched surface on side for sample identification.

Cat. #	Color	Qty/Pk	Qty/Cs
T331-20N	Natural	500	5000
T331-20B*	Blue	500	5000
T331-20G*	Green	500	5000
T331-20Y*	Yellow	500	5000

\*Available on request only. Minimum quantities apply. Please enquire for more details.

## T330-64

### Microcentrifuge Tube Storage Box

Made of high impact polystyrene

This microcentrifuge tube storage box with a polyurethane foam insert is ideal for holding up to 64 tubes from 0.5 ml to 2 ml. It should be used within a temperature range of -90 °C to 80 °C.

A transparent cover allows you to see the contents of the box, and is keyed to the base in order to prevent misalignment. To improve your inventory control, you can write with a marker pen on the cover surface which is pre-printed with a series of squares (numbered from 1 to 64). You can also save space by stacking these boxes in freezers, refrigerators and on lab counters.

Cat. #	Qty/Pk	Qty/Cs
T330-64	4	24

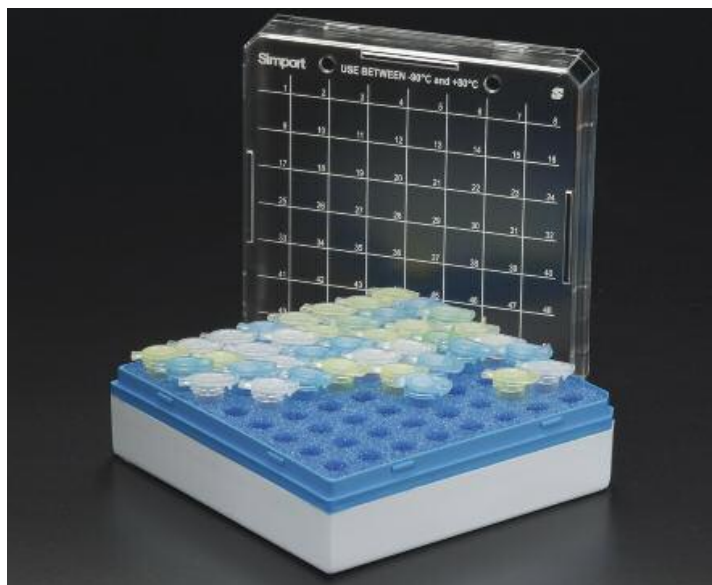



# Micrewtube® Collection

## A tube for every application

A Simport® MICREWUBE® has a multitude of applications around your lab. It is ideal for freezer storage, boiling application, centrifugation etc. and will fit most standard microcentrifuge rotors.

Six styles of caps to choose from, and three sizes of conical bottom or self-standing tubes (0.5 ml, 1.5 ml and 2 ml).

The cap is molded with a deep internal lip that fits snugly against the interior wall of the tube thus preventing the contents from coming in contact with the seal or threads, thereby reducing the chances of sample contamination. The cap's high profile facilitates manipulation especially in aseptic procedures and can remain attached (T332 & T336 Series) to the tube in order to eliminate mix-ups. All tubes and closures are manufactured in a clean environment.

Tubes and screw caps are made of heavy wall construction and are built to last. Non skirted tubes withstand high speed centrifugation up to 20,000g. In the O-ring version, tubes and caps are made of polypropylene while in the lip seal version, tubes are made of polypropylene and caps are made of high density polyethylene. They are available in sterile and non sterile format.

Low adhesion Micrewtubes Series T341TLST are also available. The specially formulated polypropylene used to manufacture these tubes provides a low adhesion surface to obtain maximum sample yield.

Total length with cap: 47 mm. Outside diameter of cap: 13 mm, Height of cap: 8.5 mm

All sterile tubes are gamma irradiated and packaged in tamperproof, resealable bags to protect remaining tubes from contamination. They are identified in the list with an "S" after the catalog number. Sterile tubes are also available with graduations and a white marking area for sample identification. They are identified in the list with an "SPR" after the catalog number.

Note: The 0.5 and 2.0 ml self-standing Micrewtube® cannot be used directly in certain fixed angle microcentrifuges. Please check to ensure there is sufficient clearance between bottom of tube and rotor chamber wall during centrifugation. Test at full speed with water in a capped tube.

**WARNING:** Do not use Micrewtubes for storage in the liquid phase of liquid nitrogen. Such use may cause entrapment of liquefied nitrogen inside the vial and lead to pressure build-up resulting in possible explosion or biohazard release. Use appropriate safety procedures when handling and disposing of vials.

For your peace of mind  
**A new era in sample protection**

Simport® introduces the new  
**Tamper Evident  
Micrewlock™ Family**



For applications needing  
**the utmost security**  
where sample integrity  
is of high importance:

- As a safer transport tube
- For secure short and long term storage
- As a tamper evident cryogenic vial
- In clinical trials
- As a tube containing expensive reagents in diagnostic kits



# MICROCENTRIFUGE TUBES

## Anatomy of a Tamper Evident Micrewtube®

**95kPa  
TESTED**

Available with specially designed economical silicone washer for a more secure and positive leakproof seal

Innovative tamper-evident locking ring for better protection of contents

Tubes and caps in the Micrewtube® Family are certified RNase, DNase, DNA and Pyrogen free

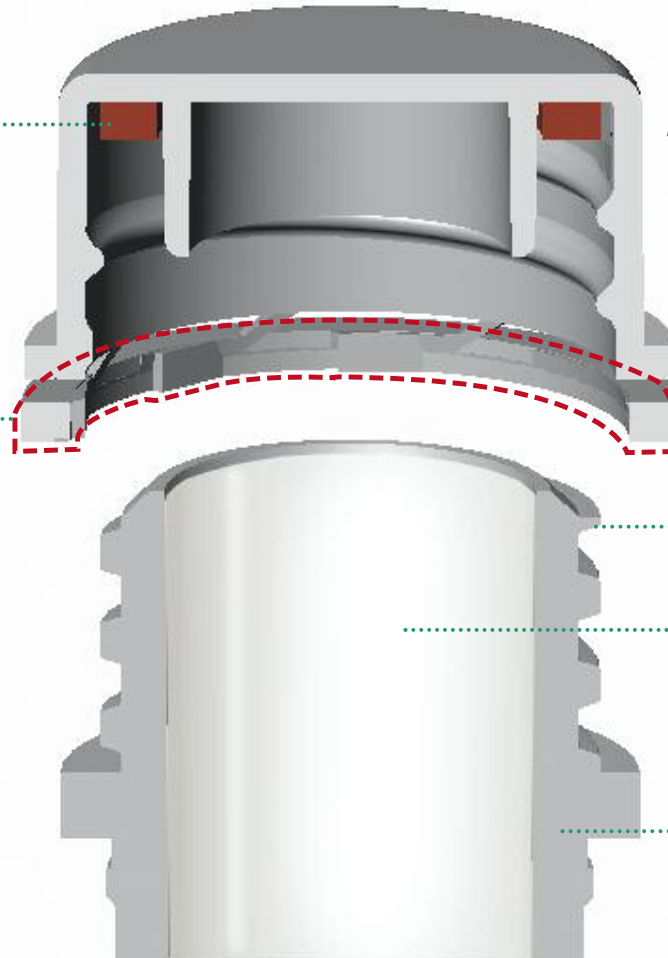

*If you **TRULY** care about your sample, let us help you **PROTECT** its integrity!*

Super fast 1¼ turn thread design

Excellent clarity makes sample easy to see

Thick wall makes tube almost unbreakable

Cap and tube are made of autoclavable polypropylene

Made of polypropylene

At last, a TAMPER EVIDENT microcentrifuge tube incorporating all the features and benefits of the Simport® MICREW TUBE® Family. Ideal for all applications requiring a tamper evident seal, a Simport® tamperproof MICREW TUBE® also has a multitude of benefits when used in your lab. It is ideal for freezer storage, boiling applications, centrifugation etc... and will fit most standard microcentrifuge rotors.

Simply screw the cap on the tube and the tamper evident sealing ring is automatically in place. When unscrewed, the ring is detached from the tube and remains in its position, showing clearly that the tube was opened. The flat cap facilitates manipulation especially in aseptic procedures. It does not incorporate an attachment loop for users who prefer to remove it completely from the tube when filling or sampling. The washer seal secured in the cap ensures a positive leakproof seal, time after time, keeping the integrity of small samples under even the most adverse conditions. The Tamper Evident Micrewtube is available in various sterile and non sterile configurations. The tubes are available non-printed or printed with graduations and white marking area for sample identification. Conical bottom tubes can be centrifuged up to 20,000g. All tubes are gamma irradiated and packaged in tamperproof resealable bags to protect remaining tubes from contamination. Sterile tubes are also available with printed graduations and white marking area for sample identification. Tubes and caps are also available separately.

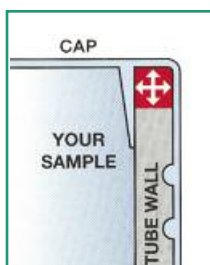

The sample remains secure thanks to the sealing ring enclosed on all four of its sides. As the cap is tightened, the sealing ring is compressed and tries to find a gap to move into.



Available with or without graduations and oversized marking area



All microcentrifuge tubes in the MicrewLock™ Family have a super clear highly polished surface for better viewing of contents.



## The Simport® Tamper Evident Microwlock™ Family



### T341TP

#### Tamper Evident Microwtube® (tube only)

Made of polypropylene

These tubes are specially made to be used with tamperproof caps. Available in plain or graduated configuration, the latter being provided with a white marking area for sample identification. Can be used at extreme temperatures from -196 °C to +121 °C.

Maximum centrifugation RCF: 20,000g. (conical bottom tubes only)

Dimensions: 44 mm H x 11 mm dia.

Plain Cat. #	Graduated Cat. #	Style	Volume (ml)	Qty/Pk
T341-2TTP	T341-2TPRTP	Self-standing	0.5	1000
T341-4TTP	T341-4TPRTP	Self-standing	1.5	1000
T341-5TTP	T341-5TPRTP	Conical bottom	1.5	1000
T341-6TTP	T341-6TPRTP	Self-standing	2.0	1000
T341-7TTP	T341-7TPRTP	Conical bottom	2.0	1000



### T340TP

#### Tamper Evident Screw Cap with O-ring Seal & Flat Top (cap only)

Made of polypropylene

The cap is molded with a deep internal lip that fits snugly against the interior wall of the tube. It will prevent the contents from coming in contact with the seal or threads, thereby reducing the chances of sample contamination. The cap's high profile facilitates manipulation especially in aseptic procedures. All tubes and closures are manufactured in a clean environment.

Cat. #	Color*	Qty/Pk
T340NOSFTTP	Natural	1000

\* The following colors are available on special order: blue, green, lilac, red, yellow, and white. Please contact a customer service representative for further details.



Other packaging configurations available. See page 124.

## How does it work ?



1 Screw Tamper Evident cap on tube until locking ring clicks over serrated tube neck.

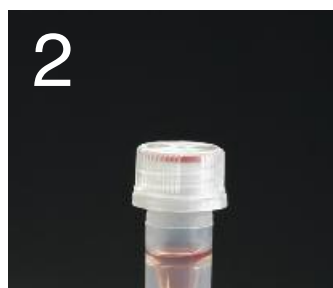

2 Contents are now protected until Tamper Evident cap is removed.



3 When unscrewing the cap, the Tamper Evident locking ring is detached and freed from closure.



4 View of separate components of a Tamper Evident Microwtube® after use.

# MICROCENTRIFUGE TUBES

## SnapTwist™ Micrewtube®

Tube made of polypropylene  
Cap made of polyethylene

The SnapTwist™ Micrewtube® provides all the advantages of a modern microcentrifuge tube with screw cap but the closure is a true time saver. The SnapTwist™ Micrewtube® has a multitude of applications around your lab. It is ideal for freezer storage, boiling application, centrifugation etc, and will fit most standard microcentrifuge rotors.

The tubes can be securely sealed by simply capping the closures on. Removal of caps requires an easy 1/4 turn (twist). The ease with which these caps can be manipulated eliminates the danger of spillage associated with other push-on/pull-off caps. The deep internal lip of the cap fits snugly against the interior wall of the tube preventing the contents from coming in contact with the threads, thus reducing the chances of sample contamination. The quality of the sealing system is such that it is not necessary to tighten the closure with pressure to achieve a leakproof seal.

This series of tubes is not available with graduations. Caps cannot be autoclaved since they are made of high density polyethylene. Conical bottom tubes can be centrifuged up to 20,000g. Temperature range: -90 °C to +100 °C. Skirted tubes can be centrifuged up to 17,000g.



### Tubes

Cat. #	Description	Volume	Qty/Pk
T342-4T	Self-Standing	1.5 ml	1000
T342-5T	Conical Bottom	1.5 ml	1000
T342-6T	Self-Standing	1.8 ml	1000
T342-7T	Conical Bottom	1.8 ml	1000

### Caps

Cat. #	Description	Color	Qty/Pk
T343NLS	Without Loop	Natural	1000
T343BLS	Without Loop	Blue	1000
T343GLS	Without Loop	Green	1000
T343LLS	Without Loop	Lilac	1000
T343RLS	Without Loop	Red	1000
T343YLS	Without Loop	Yellow	1000
T343WLS	Without Loop	White	1000

### Caps

Cat. #	Description	Color	Qty/Pk
T343NLSL	With Loop	Natural	1000
T343BLSL	With Loop	Blue	1000
T343GLSL	With Loop	Green	1000
T343LLSL	With Loop	Lilac	1000
T343RLSL	With Loop	Red	1000
T343YLSL	With Loop	Yellow	1000
T343WLSL	With Loop	White	1000



Two types of caps available. The one with attached loop helps avoid mix-ups and possible contamination.

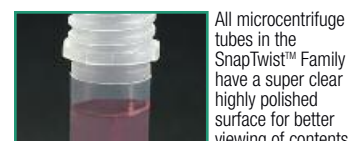

All microcentrifuge tubes in the SnapTwist™ Family have a super clear highly polished surface for better viewing of contents.

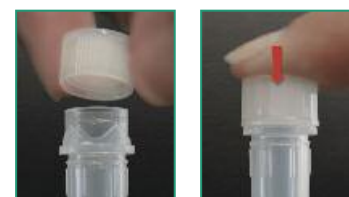

The vial can be securely sealed by simply snapping the cap on.



Removal of cap requires an easy 1/4 turn (twist).

These new tubes have molded ridges matching serrations on racks such as the Simport® T360 OneHand™ Rack on page 121.

For Capinsert™ details, please refer to T345 on page 128.



Tubes and caps in the Micrewtube® Family are certified RNase, DNase, DNA and Pyrogen free



# MICROCENTRIFUGE TUBES

**95kPa  
TESTED**

## Anatomy of a Standard Microwtube®

A Capinsert™ (see T345 on page 128) can be inserted on top of closure for sample identification

Available with specially designed lip seal and silicone washer seal for a more secure and positive leakproof seal

Also available with attachment loop to prevent mix-up of caps, avoiding contamination between samples.

Super fast 1¼ turn thread design

Can withstand high speed centrifugation up to 20,000g (conical bottom tubes only)

Made of autoclavable polypropylene

Thick wall makes tube almost unbreakable

Excellent see-through clarity

On washer seal caps, samples remain secure thanks to the sealing washer being enclosed on all four of its sides.

As the cap is tightened, the sealing ring is compressed and tries to find a gap to move into.

• Available with or without graduations

• Oversized marking area

To protect samples from light, brown tubes are also available. See page 126.

Self-standing tubes have a unique locking base for use with Series T360 OneHand™ Microtube Rack (page 129).

Tubes and caps in the Microwtube® Family are certified RNase, DNase, DNA and Pyrogen free

### A wide choice of tubes and caps to fulfill all your needs

WITH WASHER SEAL			WITH LIP SEAL		
Washer seal and loop	Washer seal	Flat top and washer seal for packaging applications	Lip seal and loop	Lip seal	Flat top and lip seal for packaging applications
NON GRADUATED			GRADUATED WITH OVERSIZED WHITE MARKING SURFACE		

# MICROCENTRIFUGE TUBES



## Micrewtube® with Washer Seal Screw Cap

### T332 With Washer Seal Screw Cap and Attachment Loop



Made of polypropylene

The washer seal secured in the top of the cap ensures a positive leakproof seal, time after time, keeping the integrity of small samples under even the most adverse conditions. This series of tubes is available either plain or with printed graduations and white marking area for sample identification. Caps are supplied with attachment loops, and allow them to remain attached to the tube in order to prevent mix-up and contamination. These microcentrifuge tubes have all the other fine features stated in the general description. Perfect for cryogenic work. Non skirted tubes can be centrifuged up to 20,000g. Skirted tubes can be centrifuged up to 17,000g. Will withstand temperatures from -196 °C to +121 °C.



### T334 With Washer Seal Screw Cap



Made of polypropylene

Similar to the T332 Series but without the “tethered cap” feature. This series of tubes is available either plain or with printed graduations and white marking area for sample identification. The caps do not have the attachment loops for users who prefer to remove the caps completely from the tubes when filling or sampling. These microcentrifuge tubes have all the other fine features stated in the general description. Perfect for cryogenic work. Non skirted tubes can be centrifuged up to 20,000g. Skirted tubes can be centrifuged up to 17,000g. Will withstand temperatures from -196 °C to +121 °C.



Tubes and caps in the Micrewtube® Family are certified RNase, DNase, DNA and Pyrogen free



### T335 With Washer Seal and Flat Screw Cap



Made of polypropylene

This series of tubes is also available either plain or with printed graduations and white marking area for sample identification. Washer seal screw caps are unattached but incorporate a flat top which provides a writing surface. These flat surfaced caps can be used with automatic capping machines in packaging industries. Closures are supplied in natural color. Perfect for cryogenic work. Non skirted tubes can be centrifuged up to 20,000g. Skirted tubes can be centrifuged up to 17,000g. Will withstand temperatures from -196 °C to +121 °C.



## Micrewtube® with Lip Seal Screw Cap



### T336 With Lip Seal Screw Cap and Attachment Loop



Made of polypropylene  
Cap made of polyethylene



The flexible sealing lip inside the cap ensures a positive leakproof seal under even the most adverse conditions. This deep internal lip fits snugly against the interior wall of the tube preventing the contents from coming in contact with the threads, thus reducing the chances of sample contamination. This series of tubes is available either plain or with printed graduations and white marking area for sample identification. Caps are supplied with attachment loops in order to prevent contamination and mix-up. These microcentrifuge tubes have all the other fine features stated in the introduction page, but cannot be autoclaved since closure is made of high density polyethylene. Non skirted tubes can be centrifuged up to 20,000g. Skirted tubes can be centrifuged up to 17,000g. Will withstand temperatures from -196 °C to +110 °C.

### T338 With Lip Seal Screw Cap



Made of polypropylene  
Cap made of polyethylene



Similar to the T336 Series but without the “tethered cap” feature. This series of tubes is available either plain or with printed graduations and white marking area for sample identification. They have all the other fine features of the T336 series of tubes, but the caps are not supplied with the attachment loop for users who prefer to remove the caps completely from the tubes when filling or sampling. Cannot be autoclaved since closure is made of high density polyethylene. Non skirted tubes can be centrifuged up to 20,000g. Skirted tubes can be centrifuged up to 17,000g. Will withstand temperatures from -196 °C to +110 °C.

### T339 With Lip Seal and Flat Screw Cap



Made of polypropylene  
Cap made of polyethylene



This series of tubes is available either plain or with printed graduations and white marking area for sample identification. Lip seal screw caps are unattached but incorporate a flat top which provides a writing surface. These flat surfaced tubes can also be used with automatic capping machines and in packaging industries. Closures are supplied in natural color. Tubes are made of polypropylene while polyethylene caps are easy to screw on and off. More economical than T335 Series O-ring seal model. Cannot be autoclaved since closure is made of high density polyethylene. Non skirted tubes can be centrifuged up to 20,000g. Skirted tubes can be centrifuged up to 17,000g.

Tubes and caps in the Micrewtube® Family are certified RNase, DNase, DNA and Pyrogen free



# SELECTION CHART

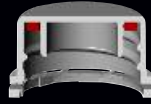

**Tamperproof Screw Cap  
With washer seal  
and flat top**



**With washer seal  
and attachment loop**

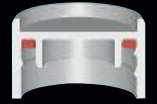

**With washer seal**



**Self-standing  
0.5 ml**

T335-2TP Non sterile	Cap not assembled and Non graduated	T332-2 Non sterile	Cap loops are pre-attached but caps are not screwed on and Non graduated	T334-2 Non sterile	Cap not assembled and Non graduated
T335-2STP Sterile	Caps are slightly screwed on and Non graduated	T332-2S Sterile	Pre-attached caps are screwed on and Non graduated	T334-2S Sterile	Caps are screwed on and Non graduated
T335-2SPRTP Sterile	Caps are slightly screwed on, white marking area and graduations	T332-2SPR Sterile	Pre-attached caps are screwed on, white marking area and graduations	T334-2SPR Sterile	Caps are screwed on, white marking area and graduations



**Self-standing  
1.5 ml**

T335-4TP Non sterile	Cap not assembled and Non graduated	T332-4 Non sterile	Cap loops are pre-attached but caps are not screwed on and Non graduated	T334-4 Non sterile	Cap not assembled and Non graduated
T335-4STP Sterile	Caps are slightly screwed on and Non graduated	T332-4S Sterile	Pre-attached caps are screwed on and Non graduated	T334-4S Sterile	Caps are screwed on and Non graduated
T335-4SPRTP Sterile	Caps are slightly screwed on, white marking area and graduations	T332-4SPR Sterile	Pre-attached caps are screwed on, white marking area and graduations	T334-4SPR Sterile	Caps are screwed on, white marking area and graduations



**Conical bottom  
1.5 ml**

T335-5TP Non sterile	Cap not assembled and Non graduated	T332-5 Non sterile	Cap loops are pre-attached but caps are not screwed on and Non graduated	T334-5 Non sterile	Cap not assembled and Non graduated
T335-5STP Sterile	Caps are slightly screwed on and Non graduated	T332-5S Sterile	Pre-attached caps are screwed on and Non graduated	T334-5S Sterile	Caps are screwed on and Non graduated
T335-5SPRTP Sterile	Caps are slightly screwed on, white marking area and graduations	T332-5SPR Sterile	Pre-attached caps are screwed on, white marking area and graduations	T334-5SPR Sterile	Caps are screwed on, white marking area and graduations



**Self-standing  
2.0 ml**

T335-6TP Non sterile	Cap not assembled and Non graduated	T332-6 Non sterile	Cap loops are pre-attached but caps are not screwed on and Non graduated	T334-6 Non sterile	Cap not assembled and Non graduated
T335-6STP Sterile	Caps are slightly screwed on and Non graduated	T332-6S Sterile	Pre-attached caps are screwed on and Non graduated	T334-6S Sterile	Caps are screwed on and Non graduated
T335-6SPRTP Sterile	Caps are slightly screwed on, white marking area and graduations	T332-6SPR Sterile	Pre-attached caps are screwed on, white marking area and graduations	T334-6SPR Sterile	Caps are screwed on, white marking area and graduations



**Conical bottom  
2.0 ml**

T335-7TP Non sterile	Cap not assembled and Non graduated	T332-7 Non sterile	Cap loops are pre-attached but caps are not screwed on and Non graduated	T334-7 Non sterile	Cap not assembled and Non graduated
T335-7STP Sterile	Caps are slightly screwed on and Non graduated	T332-7S Sterile	Pre-attached caps are screwed on and Non graduated	T334-7S Sterile	Caps are screwed on and Non graduated
T335-7SPRTP Sterile	Caps are slightly screwed on, white marking area and graduations	T332-7SPR Sterile	Pre-attached caps are screwed on, white marking area and graduations	T334-7SPR Sterile	Caps are screwed on, white marking area and graduations

**PACKAGING  
INFORMATION**

	Qty/Pk	Qty/Cs		Qty/Pk	Qty/Cs		Qty/Pk	Qty/Cs
Non Sterile	-	1000	Non Sterile	-	1000	Non Sterile	-	1000
Sterile	50	500	Sterile	50	500	Sterile	50	500

# SELECTION CHART



With washer seal and flat top



With lip seal and attachment loop



With lip seal



With lip seal and flat top

T335-2 Non sterile Caps not assembled and Non graduated

T335-2S Sterile Caps are screwed on and Non graduated

T335-2SPR Sterile Caps are screwed on, white marking area and graduations

T335-4 Non sterile Caps not assembled and Non graduated

T335-4S Sterile Caps are screwed on and Non graduated

T335-4SPR Sterile Caps are screwed on, white marking area and graduations

T335-5 Non sterile Caps not assembled and Non graduated

T335-5S Sterile Caps are screwed on and Non graduated

T335-5SPR Sterile Caps are screwed on, white marking area and graduations

T335-6 Non sterile Caps not assembled and Non graduated

T335-6S Sterile Caps are screwed on and Non graduated

T335-6SPR Sterile Caps are screwed on, white marking area and graduations

T335-7 Non sterile Caps not assembled and Non graduated

T335-7S Sterile Caps are screwed on and Non graduated

T335-7SPR Sterile Caps are screwed on, white marking area and graduations

T336-2 Non sterile Cap loops are pre-attached but caps are not screwed on and Non graduated

T336-2S Sterile Pre-attached caps are screwed on and Non graduated

T336-2SPR Sterile Pre-attached caps are screwed on, white marking area and graduations

T336-4 Non sterile Cap loops are pre-attached but caps are not screwed on and Non graduated

T336-4S Sterile Pre-attached caps are screwed on and Non graduated

T336-4SPR Sterile Pre-attached caps are screwed on, white marking area and graduations

T336-5 Non sterile Cap loops are pre-attached but caps are not screwed on and Non graduated

T336-5S Sterile Pre-attached caps are screwed on and Non graduated

T336-5SPR Sterile Pre-attached caps are screwed on, white marking area and graduations

T336-6 Non sterile Cap loops are pre-attached but caps are not screwed on and Non graduated

T336-6S Sterile Pre-attached caps are screwed on and Non graduated

T336-6SPR Sterile Pre-attached caps are screwed on, white marking area and graduations

T336-7 Non sterile Cap loops are pre-attached but caps are not screwed on and Non graduated

T336-7S Sterile Pre-attached caps are screwed on and Non graduated

T336-7SPR Sterile Pre-attached caps are screwed on, white marking area and graduations

T338-2 Non sterile Caps are not assembled and Non graduated

T338-2S Sterile Caps are screwed on and Non graduated

T338-2SPR Sterile Caps are screwed on, white marking area and graduations

T338-4 Non sterile Caps are not assembled and Non graduated

T338-4S Sterile Caps are screwed on and Non graduated

T338-4SPR Sterile Caps are screwed on, white marking area and graduations

T338-5 Non sterile Caps are not assembled and Non graduated

T338-5S Sterile Caps are screwed on and Non graduated

T338-5SPR Sterile Caps are screwed on, white marking area and graduations

T338-6 Non sterile Caps are not assembled and Non graduated

T338-6S Sterile Caps are screwed on and Non graduated

T338-6SPR Sterile Caps are screwed on, white marking area and graduations

T338-7 Non sterile Caps are not assembled and Non graduated

T338-7S Sterile Caps are screwed on and Non graduated

T338-7SPR Sterile Caps are screwed on, white marking area and graduations

T339-2 Non sterile Caps not assembled and Non graduated

T339-2S Sterile Caps are screwed on and Non graduated

T339-2SPR Sterile Caps are screwed on, white marking area and graduations

T339-4 Non sterile Caps not assembled and Non graduated

T339-4S Sterile Caps are screwed on and Non graduated

T339-4SPR Sterile Caps are screwed on, white marking area and graduations

T339-5 Non sterile Caps not assembled and Non graduated

T339-5S Sterile Caps are screwed on and Non graduated

T339-5SPR Sterile Caps are screwed on, white marking area and graduations

T339-6 Non sterile Caps not assembled and Non graduated

T339-6S Sterile Caps are screwed on and Non graduated

T339-6SPR Sterile Caps are screwed on, white marking area and graduations

T339-7 Non sterile Caps not assembled and Non graduated

T339-7S Sterile Caps are screwed on and Non graduated

T339-7SPR Sterile Caps are screwed on, white marking area and graduations

	Qty/Pk	Qty/Cs
Non Sterile	-	1000
Sterile	50	500

	Qty/Pk	Qty/Cs
Non Sterile	-	1000
Sterile	50	500

	Qty/Pk	Qty/Cs
Non Sterile	-	1000
Sterile	50	500

	Qty/Pk	Qty/Cs
Non-Sterile	-	1000
Sterile	50	500

# MICROCENTRIFUGE TUBES

## T341T

### MICREWUBE® Plain

Made of polypropylene

Can be used at extreme temperatures from -196 °C to +121 °C.



Cat. #	Style	Volume (ml)	Qty/Pk
T341-2T	Self-standing	0.5	1000
T341-4T	Self-standing	1.5	1000
T341-5T	Conical bottom	1.5	1000
T341-6T	Self-standing	2.0	1000
T341-7T	Conical bottom	2.0	1000



Maximum centrifugation RCF: 20,000g (for non-skirted tubes only).  
Dimensions: 44 mm H x 11 mm dia.

## T341TPR

### MICREWUBE® Graduated

Made of polypropylene

For your special needs, these tubes are identical to the T341 Series but are graduated and are provided with a white marking area for sample identification. Can be used at extreme temperatures from -196 °C to +121 °C.

Cat. #	Style	Volume (ml)	Qty/Pk
T341-2TPR	Self-standing	0.5	1000
T341-4TPR	Self-standing	1.5	1000
T341-5TPR	Conical bottom	1.5	1000
T341-6TPR	Self-standing	2.0	1000
T341-7TPR	Conical bottom	2.0	1000



Maximum centrifugation RCF: 20,000g (for non-skirted tubes only).  
Dimensions: 44 mm H x 11 mm dia.

## T341TBR

### MICREWUBE®

#### For Light Sensitive Material

Made of polypropylene

These ungraduated tubes are identical to series T341 but their dark brown color allows them to be used when storing light-sensitive material. Can be used at extreme temperatures from -196 °C to +121 °C.

Cat. #	Style	Volume (ml)	Qty/Pk
T341-2TBR	Self-standing	0.5	1000
T341-4TBR	Self-standing	1.5	1000
T341-5TBR	Conical bottom	1.5	1000
T341-6TBR	Self-standing	2.0	1000
T341-7TBR	Conical bottom	2.0	1000



Maximum centrifugation RCF: 20,000g (for non-skirted tubes only).  
Dimensions: 44 mm H x 11 mm dia.

## T341TLST

### MICREWUBE®

#### With Low Adhesion Surface

Made of polypropylene

Having all the advantages of our popular T341T Series, the specially formulated polypropylene used to manufacture these tubes provides a low adhesion surface to obtain maximum sample yield. Ideal for research procedures such as nucleic acid amplifications, protein work and others. No lubricants (such as silicone) necessary, thereby eliminating the danger of sample contamination. Can be used at extreme temperatures from -196 °C to +121 °C.

Cat. #	Style	Volume (ml)	Qty/Pk
T341-2TLST	Self-standing	0.5	1000
T341-4TLST	Self-standing	1.5	1000
T341-5TLST	Conical bottom	1.5	1000
T341-6TLST	Self-standing	2.0	1000
T341-7TLST	Conical bottom	2.0	1000



Maximum centrifugation RCF: 20,000g (for non-skirted tubes only).  
Dimensions: 44 mm H x 11 mm dia.

Tubes in the Micrewtube® Family are certified RNase, DNase, DNA and Pyrogen free



## T361T

### MICREW TUBE® with Molded Ridges

These new tubes have molded ridges matching serrations on racks such as the Simport T360 OneHand™ Microtube Rack on page 129, thus allowing the removal of caps with one hand. All Simport Micrewtube® closures (below and on page 128) can be used on these tubes. Made of polypropylene.



Tubes with ribs lock in place when engaged in serrated holes. For details on OneHand™ Microtube Rack, see page 129.



### T361T MICREW TUBE® Plain



Cat. #	Style	Volume (ml)	Qty/Pk
T361-2T	Self-standing	0.5	1000
T361-4T	Self-standing	1.5	1000
T361-5T	Conical bottom	1.5	1000
T361-6T	Self-standing	2.0	1000
T361-7T	Conical bottom	2.0	1000



### T361TPR MICREW TUBE® Graduated

Cat. #	Style	Volume (ml)	Qty/Pk
T361-2TPR	Self-standing	0.5	1000
T361-4TPR	Self-standing	1.5	1000
T361-5TPR	Conical bottom	1.5	1000
T361-6TPR	Self-standing	2.0	1000
T361-7TPR	Conical bottom	2.0	1000



### T361TBR MICREW TUBE® For Light Sensitive Material

Cat. #	Style	Volume (ml)	Qty/Pk
T361-2TBR	Self-standing	0.5	1000
T361-4TBR	Conical bottom	1.5	1000
T361-5TBR	Without skirt	1.5	1000
T361-6TBR	Conical bottom	2.0	1000
T361-7TBR	Without skirt	2.0	1000



### T347AQX Septum Screw Cap For Microcentrifuge Tubes

Made of polypropylene

The T347AQX screw cap incorporates a pierceable septum made of chemically resistant PTFE on the outside and silicone on the inside, both components being stable over a broad range of temperatures. The septum also acts as a silicone o-ring for better sample protection. It is especially made to fit and be used with all Simport Micrew™ Microcentrifuge Tubes. The cap is pierceable with pipet tips as well as with syringe needles.

Tubes and caps in the Micrewtube® Family are certified RNase, DNase, DNA and Pyrogen free

Cat. #	Description	Qty/Pk
T347AQX	Septum Screw Cap for Micrew Microcentrifuge Tubes	250

## T340 Colored Closures

Six styles of caps to choose from and two sealing types: washer seal and lip seal.

The cap is molded with a deep internal lip that fits snugly against the interior wall of the tube thus preventing the contents from coming in contact with the seal or threads, thereby reducing the chances of sample contamination. The cap's high profile facilitates manipulation especially in aseptic procedures and can remain attached (T332 & T336 Series) to the tube in order to eliminate mix-ups and contamination. All tubes and closures are manufactured in a clean environment.

Closures can be COLOR CODED by the use of T345 Series Colored Capinsert™ inserted on the top of the closure. This is accomplished without removing the cap. Colored caps are also available in all models as listed below.



With WASHER SEAL and without loop. Made of polypropylene.

LIP SEAL and without loop. Made of polyethylene.

With WASHER SEAL and loop. Made of polypropylene.

LIP SEAL and loop. Made of polyethylene.

Cat. #	Cat. #	Color	Qty/Pk
T340 NOS	T340 NLS	Natural	1000
T340 BOS	T340 BLS	Blue	1000
T340 GOS	T340 GLS	Green	1000
T340 LOS	T340 LLS	Lilac	1000
T340 OOS	T340 OLS	Orange	1000
T340 ROS	T340 RLS	Red	1000
T340 YOS	T340 YLS	Yellow	1000
T340 WOS	T340 WLS	White	1000
T340 BROS	T340 BRSL	Brown	1000

Cat. #	Cat. #	Color	Qty/Pk
T340 NOSL	T340 NLSL	Natural	1000
T340 BOSL	T340 BLSL	Blue	1000
T340 GOSL	T340 GLSL	Green	1000
T340 LOSL	T340 LLSL	Lilac	1000
T340 OOSL	T340 OLSL	Orange	1000
T340 ROSL	T340 RLSL	Red	1000
T340 YOSL	T340 YLSL	Yellow	1000
T340 WOSL	T340 WLSL	White	1000
T340 BROS	T340 BRSL	Brown	1000

The following closures have a flat top to accommodate automatic capping machines in packaging industries.



With WASHER SEAL and without loop. Made of polypropylene.

LIP SEAL and without loop. Made of polyethylene.

Cat. #	Cat. #	Color	Qty/Pk
T340 NOSFT	T340 NLSFT	Natural	1000
T340 BOSFT	T340 BLSFT	Blue	1000
T340 GOSFT	T340 GLSFT	Green	1000
T340 LOSFT	T340 LLSFT	Lilac	1000
T340 OOSFT	T340 OLSFT	Orange	1000
T340 ROSFT	T340 RLSFT	Red	1000
T340 YOSFT	T340 YLSFT	Yellow	1000
T340 WOSFT	T340 WLSFT	White	1000
T340 BROSFT	T340 BRSLFT	Brown	1000

## T345

### Color Coding CAPINSERT™



Made of polypropylene

The Capinsert™ is used to color code a Microwtube® and a multitude of other Simport products according to your specific needs. It is inserted on top of the closure and has a write-on frosted area for sample identification.

Cat. #	Color	Cat. #	Color	Qty/Bag
T345B	Blue	T345P	Pink	500
T345GY	Gray	T345R	Red	500
T345G	Green	T345V	Violet	500
T345L	Lilac	T345W	White	500
T345O	Orange	T345Y	Yellow	500
		T345AS	Assorted*	500

\* Blue, lilac, red, yellow and white

## T360 OneHand™ Microtube Rack

Made of acetal

A newly designed microtube rack that can be used all around the lab. Although one of the most attractive racks available today, it offers all the advantages required by the modern laboratory. Made of highly resistant acetal, it will not shatter or stain in contact with most laboratory chemicals. No coating to worry about, which can chip, peel or rust in a water bath.

The OneHand™ Microtube Rack is compact, lightweight and stackable in order to save as much space as possible. This is why it is ideal for incubators, refrigerators, freezers, under lab hoods and on bench tops. Not only is it submersible but will also sink and maintain stability without tipping over.

The OneHand™ Microtube Rack is made of 2 tiers to facilitate the insertion and stability of microtubes. Now with one hand, you can easily unscrew just about any type of microcentrifuge tube with a screw-on closure. Thanks to an innovative locking system, the Simport self-standing Micrewtubes® will securely lock in each well of the base tier and will not turn. All models of microtubes made by various manufacturers will lock in the upper tier, thanks to a series of teeth grasping the collar of the microtube. Convenient handles on each side of the rack will ensure a safe grip when carrying it around. Interlocking feet allow safe stacking. Available in 5 attractive colors. Individually wrapped.

Size: 293 mm x 115 mm x 39 mm H  
(11 1/2 x 4 1/2 x 1 1/2 in. H)

### ONE HAND OPENING AND CLOSING OF MICROTUBES



Tubes with ribs lock in place when engaged in serrated holes.



The locking base of the OneHand™ Rack locks self standing Simport Micrewtubes in place.



Cat. #	Capacity	Color	Qty/Cs
T360-50B	50	Blue	10
T360-50G	50	Green	10
T360-50L	50	Lilac	10
T360-50O	50	Orange	10
T360-50Y	50	Yellow	10



## T350 MICREW TUBE® Storage Box

Made of polycarbonate

COLOR YOUR WORLD with this 100-place MICREW TUBE® Storage Box for tubes ranging from 0.5 ml. to 2 ml (except 1.5 ml conical bottom tubes). Made of extra strong polycarbonate, this durable storage box is designed to be used at temperatures between -196 °C and +121 °C and is autoclavable.

A transparent cover allows the user to see the contents of the box, and is keyed to the base to prevent misalignment. Printed with a series of squares (numbered from 1 to 100), the surface accepts writing with markers, for better inventory control.

Samples can be classified more easily, thanks to a series of colored bases. A choice of four popular colors is available: blue, green, red and yellow.

Size: 133 mm x 133 mm x 52 mm H (5 1/4 x 5 1/4 x 2 1/16 in. H)

Cat. #	For Micrewtubes	Color of base	Qty/Pk	Qty/Cs
T350-100B	0.5 to 2 ml	Blue	4	24
T350-100G	0.5 to 2 ml	Green	4	24
T350-100R	0.5 to 2 ml	Red	4	24
T350-100Y	0.5 to 2 ml	Yellow	4	24

# CULTURE TUBES

## T400 Disposable Culture Tubes

NON STERILE

Made of either polystyrene or polypropylene

Ideal for use in bacteriology, RIA, coagulation and other routine laboratory procedures. Simport uses no mold release agents that could cause errors and interferences in RIA tests. Precision molding with virgin thermoplastics ensures that our tubes are uniform in size and shape as well as being chemically clean and ready to use.

The polypropylene tubes are translucent and will withstand over 3000g during centrifugation. They will also accept most common acids, solvents and alkalies at room temperature. They are almost unbreakable and can be sterilized at 120° C.

Polystyrene tubes are transparent and will withstand centrifugation speeds up to 1400g. Clear plastic guarantees no danger of glass activation during testing. Polystyrene will tolerate aqueous solutions, mild bases and weak acids, but not organic solvents, aromatic or chlorinated hydrocarbons, and cannot be autoclaved.

The T400-3ALST 12 mm x 75 mm tubes are made with a specially formulated polypropylene providing a **low surface tension** to obtain optimum sample yield. No lubricants have to be added, thereby eliminating the danger of sample contamination.



### 12 x 75 mm dia. tubes

Cat. #	Material	Vol. (ml)	Color	Qty/Pk	Qty/Cs
T400-3	Polystyrene	5	Natural	250	1000
T400-3B	Polystyrene	5	Blue	250	1000
T400-3G	Polystyrene	5	Green	250	1000
T400-3O	Polystyrene	5	Orange	250	1000
T400-3Y	Polystyrene	5	Yellow	250	1000
T400-3A	Polypropylene	5	Natural	250	1000
T400-3AAM	Polypropylene	5	Amber	250	1000
T400-3AB	Polypropylene	5	Blue	250	1000
T400-3AG	Polypropylene	5	Green	250	1000
T400-3AO	Polypropylene	5	Orange	250	1000
T400-3AY	Polypropylene	5	Yellow	250	1000

### 13 x 100, 16 x 100 and 17 x 95 mm dia. tubes

Cat. #	Material	Dim. (mm)	Vol. (ml)	Color	Qty/Cs
T400-4	Polystyrene	13 x 100	7.2	Natural	1000
T400-4V	Polystyrene	13 x 100	8	Natural	1000
T400-7	Polystyrene	16 x 100	12	Natural	1000
T400-10	Polystyrene	17 x 95	14	Natural	1000
T400-4A	Polypropylene	13 x 100	7.2	Natural	1000
T400-4AV	Polypropylene	13 x 100	8	Natural	1000
T400-7A	Polypropylene	16 x 100	12	Natural	1000
T400-10A	Polypropylene	17 x 95	14	Natural	1000

### 12 x 75 mm with low surface tension

Cat. #	Material	Vol. (ml)	Color	Qty/Cs
T400-3ALST	Polypropylene	5	Natural	1000

### 12 x 75 mm with 2-position polyethylene snap cap

Cat. #	Material	Vol. (ml)	Color	Qty/Cs
T400-3DS	Polystyrene	5	Natural	1000
T400-3ADS	Polypropylene	5	Natural	1000



Have you ever considered our MultiRack™?

See S600 Series on page 143.

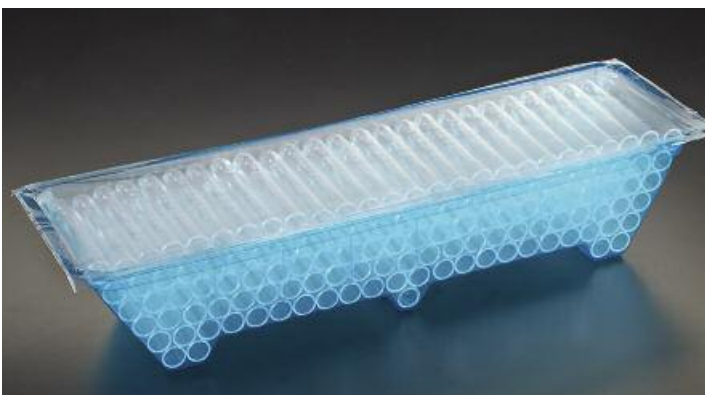

## T400-3S & -3AS

### Disposable Culture Tubes – NON STERILE

Made of either polystyrene or polypropylene

These natural color 12 x 75 mm tubes are identical to T400-3 & T400-3A but are neatly packaged with the same orientation in boxes of 125.

Cat. #	Material	Vol. (ml)	Color	Qty/Pk	Qty/Cs
T400-3S	Polystyrene	5	Natural	125	1000
T400-3AS	Polypropylene	5	Natural	125	1000

## T401 Caps and Stoppers

Made of polyethylene

Plug type push-in caps and 2-position snap caps are made of polyethylene for test tubes with outside diameters of 12. Caps T401-10N to T401-10Y are specifically designed for urine tubes T408 on page 140.

Dual position caps offer two possibilities: the closed but unsealed position where samples are maintained aerobic for microbiological procedures; and the fully sealed position where the cap is pushed tight to seal the tube for anaerobic use or for storage, transfer and centrifuge applications. Not autoclavable.



Cat. #	For tubes	Cat. #	For tubes	Color	Qty/Bag	Qty/Cs
T401-3N	12 mm	T401-10N	T408	Natural	1000	4000
T401-3B	12 mm	T401-10B	T408	Blue	1000	4000
T401-3G	12 mm	T401-10G	T408	Green	1000	4000
T401-3R	12 mm	T401-10R	T408	Red	1000	4000
T401-3W	12 mm	T401-10W	T408	White	1000	4000
T401-3Y	12 mm	T401-10Y	T408	Yellow	1000	4000

## Two-Position Snap Caps



Cat. #	For tubes made of	For tubes	Color	Qty/Bag
T401-3DSPE	Polystyrene	12 mm	Natural	1000
T401-3DSPP	Polypropylene	12 mm	Natural	1000
T401-10DSPE	Polystyrene	17 mm	Natural	1000
T401-10DSPP	Polypropylene	17 mm	Natural	1000



## T402 VACUCAP™ Tube Closures

Made of polyethylene

An economical way to recap blood drawing tubes, disposable glass test tubes and plastic culture tubes. Flexible VACUCAP™ closures protect from aerosols of highly infectious microorganisms. They guard samples against cross-contamination and laboratory work areas against infection and spillage. Precision molded from low-density polyethylene, with a double-flanged seal, VACUCAP™ clamps firmly on the tube. VACUCAP™ holds fast under most rigorous procedures, including centrifugation. Not suitable for autoclaving. Designed for easy-on, easy-off use, due to the exclusive Dual Thumb Tab. Cap removal is simple and quick. VACUCAP™ closure is ideal for recapping most 13 mm and 16mm O.D. evacuated glass blood collection tubes. 13 mm style can also be used on most 12 mm plastic test tubes.

Cat. #	For tubes	Color	Qty/Pk	Qty/Cs
T402-13N	13 mm	Natural	1000	6000
T402-13B	13 mm	Blue	1000	6000
T402-13G	13 mm	Green	1000	6000
T402-13GY	13 mm	Gray	1000	6000
T402-13L	13 mm	Lavender	1000	6000
T402-13R	13 mm	Red	1000	6000
T402-13Y	13 mm	Yellow	1000	6000

Cat. #	For tubes	Color	Qty/Pk	Qty/Cs
T402-16N	16 mm	Natural	1000	6000
T402-16B	16 mm	Blue	1000	6000
T402-16G	16 mm	Green	1000	6000
T402-16GY	16 mm	Gray	1000	6000
T402-16L	16 mm	Lavender	1000	6000
T402-16R	16 mm	Red	1000	6000
T402-16Y	16 mm	Yellow	1000	6000

## T404 Flange Plug Caps



Made of polyethylene

These caps have two flexible flanges to ensure a leakproof seal. They will fit into test tubes and also in round cuvettes and centrifuge tubes.

Cat. #	For tubes	Cat. #	For tubes	Color	Qty/Pk
T404-3N	12 mm	T404-10N	16 mm	Natural	1000
T404-3B	12 mm	T404-10B	16 mm	Blue	1000
T404-3G	12 mm	T404-10G	16 mm	Green	1000
T404-3R	12 mm	T404-10R	16 mm	Red	1000
T404-3W	12 mm	T404-10W	16 mm	White	1000
T404-3Y	12 mm	T404-10Y	16 mm	Yellow	1000

Cat. #	For tubes	Color	Qty/Pk	Qty/Cs
T401-4S	13 mm	Natural	1000	4000

# TUBE CLOSURES



## T403

### FitsAll™ Universal Cap

Made of polyethylene

Designed for easy-on, easy-off use. Cap removal is simple and quick. FitsAll™ closure is ideal for recapping most 12 mm and 16 mm O.D. evacuated glass blood collection tubes.

Flexible FitsAll™ closures protect from aerosols of highly infectious microorganisms. They guard samples against cross-contamination and laboratory work areas against infection and spillage. Precision molded from low-density polyethylene, FitsAll™ fits firmly on the tube. FitsAll™ caps are very sturdy under most rigorous procedures, including centrifugation.

Available in 8 colors for easy sample identification. Not suitable for autoclaving.

Cat. #	For tubes	Color	Qty/Pk	Qty/Cs
T403N	12 - 16 mm	Natural	1000	10,000
T403BK	12 - 16 mm	Black	1000	10,000
T403B	12 - 16 mm	Blue	1000	10,000
T403GY	12 - 16 mm	Gray	1000	10,000
T403G	12 - 16 mm	Green	1000	10,000
T403L	12 - 16 mm	Lavender	1000	10,000
T403R	12 - 16 mm	Red	1000	10,000
T403Y	12 - 16 mm	Yellow	1000	10,000

## T407 Pierce-It™ Closure



The flexible plastic cap can be pierced as often as needed.

Made of thermoplastic elastomer

These disposable closures produce a firm, leak-resistant seal for glass and plastic tubes. They will protect samples from evaporation and contamination. They can be easily applied and removed with one hand. They can be punctured to allow through-cap sampling via closed-tube instrumentation systems. Will not interfere with most common chemistry, coagulation, and drug monitoring methodologies.

They can be stored in the refrigerator, in the freezer or at room temperature. They even withstand agitation in a test tube Vortex mixer. Two sizes, 13 and 16 mm fit a variety of tubes including glass evacuated blood drawing tubes. Will also fit 12 mm I.D. culture tubes. Available in 8 colors for easy identification.

Cat. #	For tubes	Cat. #	For tubes	Color	Qty/Pk
T407-12BK	13 mm	T407-16BK	16 mm	Black	1000
T407-12B	13 mm	T407-16B	16 mm	Blue	1000
T407-12GY	13 mm	T407-16GY	16 mm	Gray	1000
T407-12G	13 mm	T407-16G	16 mm	Green	1000
T407-12L	13 mm	T407-16L	16 mm	Lavender	1000
T407-12R	13 mm	T407-16R	16 mm	Red	1000
T407-12W	13 mm	T407-16W	16 mm	White	1000
T407-12Y	13 mm	T407-16Y	16 mm	Yellow	1000



For color coding purposes, use a Capinsert™ on top of the closure. Ten different colors are available. (see T345 Series)  
For more details and colors available please refer to page 120.

## T417

### Culture Tubes 13 x 100 mm with Screw Cap



Tube made of polystyrene / Cap made of polyethylene

These 8 ml screw cap tubes are available either sterile or non sterile. A special tamper evident cap is offered for applications needing the utmost security where sample integrity is of high importance. Tubes are made of optically clear polystyrene and can be centrifuged up to 3000 x g. These are not treated for cell culture. The sterile ones are sterilized by gamma radiation and are non pyrogenic.

Cat. #	Sterile	Tamper Evident	Qty/Bag	Qty/Cs
T417-4	No	No	Bulk	1000
T417-4S	Yes	No	125	1000
T417-4TP	No	Yes	Bulk	1000

## T415, T416, T425 & T426 Cultubes™ Sterile Culture Tubes



Made of polystyrene or polypropylene

These disposable sterile tubes can be used for most routine laboratory procedures. They are biologically inert and exempt from mold release agents. Precision molding with virgin thermoplastics ensures that our tubes will be uniform in size and shape. High resistance to breakage reduces danger in handling infectious or other potentially harmful cultures.

Transparent polystyrene tubes will withstand moderate centrifugation speeds (1400g) and temperatures to 70 °C. Translucent polypropylene tubes can be centrifuged at higher speeds (3000g) and resist temperatures from -190 °C to 120 °C.

Tubes are supplied with either a 2-position ribbed polyethylene cap (which can be left loose for aerobic work or sealed for anaerobic cultures) or without caps for general purpose work. Non printed Cultubes™ also available.

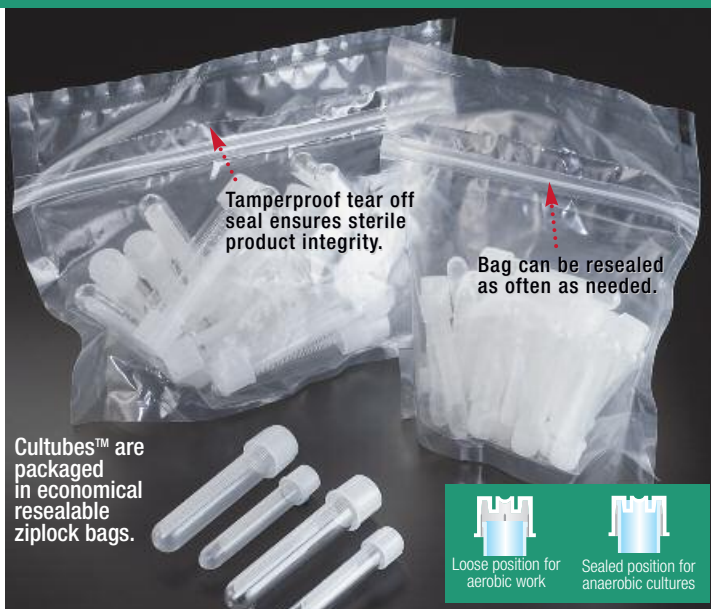

For individually wrapped Cultubes™ please refer to T405-1, T405-1A, T406-1 and T406-1A below.

Graduated Culture Tubes with White Marking Area						
Cat. #	Size (mm)	Material	Vol	Cap	Qty/Bag	Qty/Cs
T415-2	12 x 75	PS	5	Yes	25	500
T415-3	12 x 75	PS	5	Yes	125	1000
T415-6	12 x 75	PS	5	No	125	1000
T415-2A	12 x 75	PP	5	Yes	25	500
T415-6A	12 x 75	PP	5	No	125	1000
T405-33	12 x 75	PS	5	Yes	Bulk	500

Graduated Culture Tubes with White Marking Area						
Cat. #	Size (mm)	Material	Vol	Cap	Qty/Bag	Qty/Cs
T416-2	17 x 95	PS	14	Yes	25	500
T416-3	17 x 95	PS	14	Yes	125	1000
T416-6	17 x 95	PS	14	No	125	1000
T416-2A	17 x 95	PP	14	Yes	25	500
T416-6A	17 x 95	PP	14	No	125	1000
T406-33	17 x 95	PS	14	Yes	Bulk	500

NON Graduated Culture Tubes						
Cat. #	Size (mm)	Material	Vol	Cap	Qty/Bag	Qty/Cs
T425-2	12 x 75	PS	5	Yes	25	500
T425-3	12 x 75	PS	5	Yes	125	1000
T425-6	12 x 75	PS	5	No	125	1000
T425-2A	12 x 75	PP	5	Yes	25	500
T425-6A	12 x 75	PP	5	No	125	1000
T425-33	12 x 75	PS	5	Yes	Bulk	500

NON Graduated Culture Tubes						
Cat. #	Size (mm)	Material	Vol	Cap	Qty/Bag	Qty/Cs
T426-2	17 x 95	PS	14	Yes	25	500
T426-3	17 x 95	PS	14	Yes	125	1000
T426-6	17 x 95	PS	14	No	125	1000
T426-2A	17 x 95	PP	14	Yes	25	500
T426-6A	17 x 95	PP	14	No	125	1000
T426-33	17 x 95	PS	14	Yes	Bulk	500



## T405 & T406 Cultubes™ Sterile Culture Tubes

Made of either polystyrene or polypropylene

With printed graduations and white marking area

For users who prefer a more compact packaging with tubes oriented horizontally. Tubes are placed in a convenient space saving plastic tray. State-of-the-art packaging keeps your tubes neatly aligned for easing manipulation. For further details on the Cultubes, please refer to description above.

T405-1, T405-1A, T406-1 and T406-1A are all individually wrapped.

Cat. #	Size (mm)	Vol. (ml)	Material	Cap	Qty/Tray	Qty/Cs
T405-1	12 x 75	5	PS	Yes	1	500
T405-2	12 x 75	5	PS	Yes	25	500
T405-3	12 x 75	5	PS	Yes	125	1000
T405-6	12 x 75	5	PS	No	125	1000
T405-1A	12 x 75	5	PP	Yes	1	500
T405-2A	12 x 75	5	PP	Yes	25	500
T405-6A	12 x 75	5	PP	No	125	1000

Cat. #	Size (mm)	Vol. (ml)	Material	Cap	Qty/Tray	Qty/Cs
T406-1	17 x 95	14	PS	Yes	1	500
T406-2	17 x 95	14	PS	Yes	25	500
T406-3	17 x 95	14	PS	Yes	125	1000
T406-6	17 x 95	14	PS	No	125	1000
T406-1A	17 x 95	14	PP	Yes	1	500
T406-2A	17 x 95	14	PP	Yes	25	500
T406-6A	17 x 95	14	PP	No	125	1000

# SAMPLE TUBES



Screw caps sold separately

These leakproof tubes with silicone washer screw caps are tested at 13.8 PSI (95 kPa).

95kPa  
TESTED

## T500 Sample Tubes with Internal Threads

Made of polypropylene

- For storing and transporting biological material
- All polypropylene construction
- Withstand temperatures from -196 °C to 121 °C
- Withstand centrifugation
- Autoclavable
- Non sterile

High quality screw cap sample tubes manufactured of translucent autoclavable polypropylene. Tube with internal threads. Caps are supplied with or without a silicone washer, to ensure a positive leakproof seal at all temperatures. A 1/4 turn of the cap is sufficient to seal the vial. Since both closures and tubes are manufactured of the same material, they have the same coefficient of expansion to guarantee an equally secure seal both at room or at low temperatures. Round bottom tubes only can be centrifuged up to 14,000g. **Order caps separately.**

Cat. #	Vol. (ml)	Style	Size (mm)*	Qty/Pk
T500-1T	1.2	Self standing	12.5 x 43	1000
T500-2T	2	Self standing	12.5 x 49	1000
T500-4T	4	Round bottom	12.5 x 72	1000
T500-4AT	4	Self standing	12.5 x 72	1000
T500-5T	5	Round bottom	12.5 x 92	1000

\*For size only, cap is included.

## T500

### Screw Caps for Internal Thread Sample Tubes

Made of polypropylene

Caps are available either with or without a silicone washer between the cap and the tube to ensure a positive leakproof seal at all temperatures. Closures and tubes are both manufactured of polypropylene, providing the same coefficient of expansion. The cap features a long skirt and a super-fast thread design allowing it to be removed or screwed on with a single turn. Autoclavable.

THESE SILICONE WASHER CAPS WILL GUARANTEE A POSITIVE LEAKPROOF SEAL AT ALL TEMPERATURES

Cat. #	Color	Qty/Pk
T500NOS	Natural	1000
T500BOS	Blue	1000
T500GOS	Green	1000
T500LOS	Lilac	1000
T500OOS	Orange	1000
T500ROS	Red	1000
T500YOS	Yellow	1000
T500WOS	White	1000



Bar Code printing available. Contact Simport for more details.



This cap offers a positive seal using a white silicone washer.



When the cap is screwed on, the white washer is tightly secured between cap and top of tube.

Have you also considered our Transport Tubes?

See T550 & T552 on pages 138-139.



Have you also considered our Storage Boxes?

See T514 Series on pages 136-137.





## T501

### Sample Tubes with External Threads

Made of polypropylene

Designed for the storage and transportation of biological material. Manufactured from non-toxic polypropylene, the tube provides strength and clarity and exhibits some unique design features. The vial has external threads, providing a smooth and uniform inner surface, thus reducing the risk of contamination. Tubes can be autoclaved (121 °C) in upright position with caps loosened. Height of tube is with cap. Round bottom tubes only can be centrifuged up to 17,000g. **Order caps separately.**

Tubes only, not printed

Cat. #	Vol. (ml)	Style	Size (mm)*	Qty/Pk
T501-1AT	1.2	Self standing	12.5 x 43	1000
T501-2T	2.0	Round bottom	12.5 x 48	1000
T501-2AT	2.0	Self standing	12.5 x 49	1000
T501-3AT	3.0	Self standing	12.5 x 72	1000
T501-4T	4.0	Round bottom	12.5 x 75	1000
T501-4AT	4.0	Self standing	12.5 x 76	1000
T501-5T	5.0	Round bottom	12.5 x 92	1000
T501-5AT	5.0	Self standing	12.5 x 93	1000

\*For size only, cap is included.



Screw caps sold separately

These leakproof tubes with silicone washer screw caps Series T502 are tested at 13.8 PSI (95 kPa).



1783278379

Bar Code printing available. Contact Simport for more details.



Screw caps sold separately

Tubes only, graduated and with white writing area

\*For size only, cap is included.

Cat. #	Vol. (ml)	Style	Size (mm)*	Qty/Pk
T501-1ATPR	1.2	Self standing	12.5 x 43	1000
T501-2TPR	2.0	Round bottom	12.5 x 48	1000
T501-2ATPR	2.0	Self standing	12.5 x 49	1000
T501-3ATPR	3.0	Self standing	12.5 x 72	1000
T501-4TPR	4.0	Round bottom	12.5 x 75	1000
T501-4ATPR	4.0	Self standing	12.5 x 76	1000
T501-5TPR	5.0	Round bottom	12.5 x 92	1000
T501-5ATPR	5.0	Self standing	12.5 x 93	1000



## T501 & T502

### Screw Caps for Sample Tubes

Made of polypropylene

Caps are available either with or without a silicone washer between the cap and the tube to ensure a positive leakproof seal at all temperatures. As for tubes, these closures are also made of polypropylene, providing the same coefficient of expansion for both, which further enhances the leakproof qualities of the vials at changing temperatures. The cap features a long skirt and a super-fast thread design that allows it to be removed or sealed with a single turn.



Polypropylene inner lip ensures a leakproof seal.

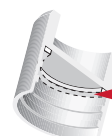

Specially designed silicone washer for increased safety.

With a lip seal

Cat. #	Color	Qty/Pk	Cat. #	Color	Qty/Pk
T501N	Natural	1000	T501O	Orange	1000
T501B	Blue	1000	T501R	Red	1000
T501DG	Dark Green	1000	T501W	White	1000
T501GY	Gray	1000	T501Y	Yellow	1000
T501L	Lilac	1000			

With a silicone washer

Cat. #	Color	Qty/Pk	Cat. #	Color	Qty/Pk
T502N	Natural	1000	T502O	Orange	1000
T502B	Blue	1000	T502R	Red	1000
T502DG	Dark Green	1000	T502W	White	1000
T502GY	Gray	1000	T502Y	Yellow	1000
T502L	Lilac	1000			

# STORAGE BOXES

## T514

### StoreBox™ Storage Boxes

Cover made of polystyrene  
Base made of high impact polystyrene

Color your world with a wide variety of economical storage boxes for tubes from 1.2 ml to 10 ml.

These storage boxes are designed to be used at temperatures between -90 °C and +80 °C. Different models are available to accommodate either 25, 42, 81 or 100 sample tubes.

A transparent cover allows the user to see the contents of the box, and is keyed to the base to prevent misalignment. Printed with a series of squares (numbered from 1 to 25, 1 to 42, 1 to 81, or 1 to 100), the surface accepts writing with markers, facilitating inventory control.

A unique color coding system uses colored plastic grids to separate the cover from the base on the 25, 42 and 81-place boxes. Those made to accept 100 tubes (series 2100) have a colored base instead of a grid. Removal of vials facilitated by an innovative vial picker supplied with each storage box (not available with box T514-542). A choice of four popular pastel colors is available. Not autoclavable.



## T514-542

### StoreBox™ Storage Box

Cover made of polystyrene  
Base made of high impact polystyrene

Will hold forty-two 10 ml Sample Tubes. Four colors are available. See page 137 for further details.

## Features and benefits of Series 225, 281, 542 & 581 Storage Boxes

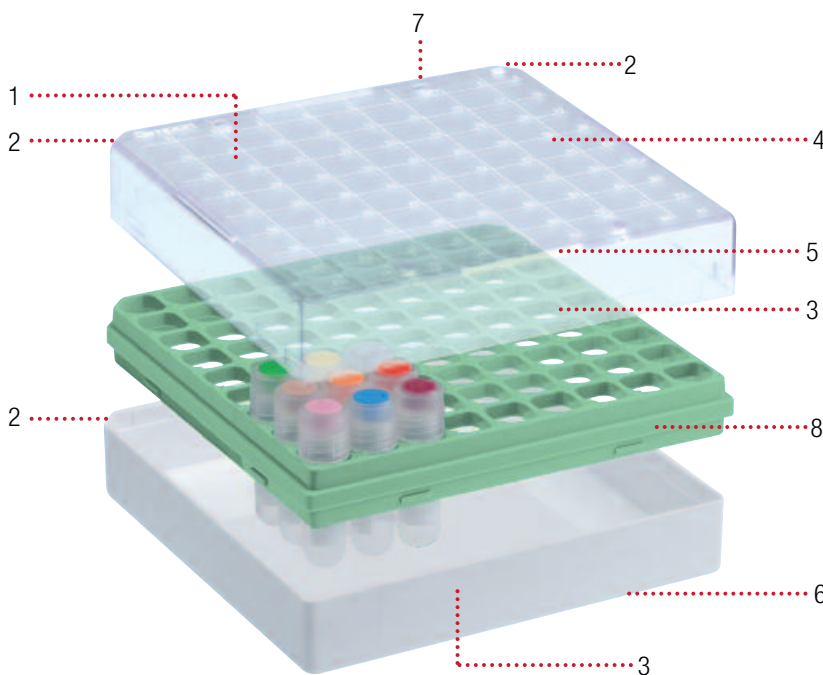

- 1 Cover has numbered squares for easy sample identification
- 2 Two corners of cover and base are cut to prevent misalignment
- 3 Writing surface for identifying base and/or cover
- 4 Vials readily visible through transparent cover
- 5 Air vents minimizing condensation
- 6 Drain holes under base
- 7 Stackable
- 8 Four pastel colors available for better color-coding



A Vial Picker is included with each StoreBox™

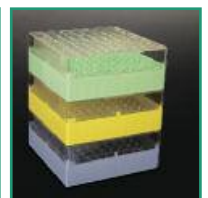

All StoreBox™ Storage Boxes are easily stackable

## StoreBox™ Selection Guide

Please note that tubes and caps are sold separately



	T500-1T	T500-2T	T500-4T	T500-4AT	T500-5T	T501-1ATPR	T501-2TPR	T501-2ATPR	T501-3ATPR	T501-4TPR	T501-4ATPR	T501-5TPR	T501-5ATPR	T550-10A
Tube Capacity (ml)	1.2	2	4	4	5	1.2	2	2	3	4	4	5	5	10
25-place Storage Box Series T514-225	•	•				•	•	•						
81-place Storage Box Series T514-281	•	•				•	•	•						
42-place Storage Box Series T514-542														•
81-place Storage Box Series T514-581			*	*	•				•	*	*	•	•	
100-place Storage Box Series T514-2100	•	•												

\* For these tubes, see T314-481 polycarbonate boxes on pages 95-97.

Series 225: 76 mm x 76 mm x 52 mm H (3 x 3 x 2 1/16 in. H)

Cat. No.	For sample tubes	Color of base	Qty/Pk	Qty/Cs
T514-225B	1 to 2 ml	Blue	8	48
T514-225G	1 to 2 ml	Green	8	48
T514-225P	1 to 2 ml	Pink	8	48
T514-225Y	1 to 2 ml	Yellow	8	48

Series 281: 133 mm x 133 mm x 52 mm H (5 1/4 x 5 1/4 x 2 1/16 in. H)

Cat. No.	For sample tubes	Color of base	Qty/Pk	Qty/Cs
T514-281B	1 to 2 ml	Blue	4	24
T514-281G	1 to 2 ml	Green	4	24
T514-281P	1 to 2 ml	Pink	4	24
T514-281Y	1 to 2 ml	Yellow	4	24

Series 542: 133 mm x 133 mm x 95 mm H (5 1/4 x 5 1/4 x 3 3/4 in. H)

Cat. No.	For sample tubes	Color of base	Qty/Pk	Qty/Cs
T514-542B	10 ml	Blue	5	10
T514-542G	10 ml	Green	5	10
T514-542P	10 ml	Pink	5	10
T514-542Y	10 ml	Yellow	5	10

Series 581: 133 mm x 133 mm x 95 mm H (5 1/4 x 5 1/4 x 3 3/4 in. H)

Cat. No.	For sample tubes	Color of base	Qty/Pk	Qty/Cs
T514-581B	3 to 5 ml	Blue	5	10
T514-581G	3 to 5 ml	Green	5	10
T514-581P	3 to 5 ml	Pink	5	10
T514-581Y	3 to 5 ml	Yellow	5	10

Series 2100: 133 mm x 133 mm x 52 mm H (5 1/4 x 5 1/4 x 2 1/16 in. H)

Cat. No.	For sample tubes	Color of base	Qty/Pk	Qty/Cs
T514-2100B	1 to 2 ml	Blue	4	24
T514-2100G	1 to 2 ml	Green	4	24
T514-2100P	1 to 2 ml	Pink	4	24
T514-2100Y	1 to 2 ml	Yellow	4	24

## T504AQX Septum Screw Cap For Sample Tubes

Made of Polypropylene

The T504AQX screw cap incorporates a pierceable septum made of chemically resistant PTFE on the outside and silicone on the inside, both components being stable over a broad range of temperatures. The septum also acts as a silicone washer seal for better sample protection. It is especially made to fit and be used with all Simport Sample Tubes. The cap is pierceable with pipet tips as well as with syringe needles.



The cap is pierceable with pipet tips as well as with syringe needles.



Cat. No.	Description	Qty/Pk
T504AQX	Septum Screw Cap for Sample Tubes	250

# TRANSPORT TUBES

## T550 & T552

### Self-Standing Non Sterile Transport Tubes



5 ml



7 ml



10 ml



12 ml



30 ml

Tube made of polypropylene / Cap made of polyethylene

Designed for storage and transportation of biological material. Manufactured from non-toxic polypropylene, tubes provide strength and clarity and exhibit some unique design features. Five sizes are available from 5 to 30 ml. The T550-10ATPR tube has a white marking area to make sample identification more convenient. All graduated tubes are in 0.5 ml increments. They have external threads to provide a smooth and uniform inner surface.

A perfect leakproof seal is obtained by the use of a specially designed flexible sealing lip inside the polyethylene closures. Cap also feature a long skirt and a super fast thread design allowing them to be removed or sealed with a single turn. The most secure seal is provided by using a special cap (T550WOS, T552WOS) featuring an exclusive silicone washer seal. These caps however do not fit on the 7 ml tube. **Tubes and caps are sold separately.**

Used extensively in the following laboratories:

- Protein Chemistry
- Molecular Biology
- Tissue Culture
- Pharmaceutical
- Toxicology
- Horticulture/Agriculture
- Nutritional Science
- Food and Beverage
- Chemistry
- Biology
- Quality Control
- Immunology



Bar Code printing available.  
Contact Simport for more details.

**SCREW CAPS  
SOLD SEPARATELY**

T550W & T552W

Specially designed inner lip ensures a leakproof seal



T550WOS

With silicone O-ring for the most secure seal



#### Tubes

Cat. #	Dimensions (mm)*	Graduations	Volume	Qty/Pk
T552-5ATTP	16.6 x 65	Etched on tube	5 ml	1000
T552-7AT	13.4 x 84	Non graduated	7 ml	1000
T550-10AT	16.6 x 85	Non graduated	10 ml	1000
T550-10ATPR	16.6 x 85	Printed on tube	10 ml	1000
T552-10ATTP	16.6 x 84	Etched on tube	10 ml	1000
T552-12ATTP	16.6 x 102	Etched on tube	12 ml	1000
T552-30AT	25.3 x 111	Etched on tube	30 ml	5 Pk of 100 / 500/Cs

\*For dimensions only, cap is included but should be ordered separately

#### Caps

Cat. #	Description	For Tubes	Capinsert	Qty/Pk
T550W	White Cap with Lip Seal	T550-10AT & -ATPR	No	1000
T550WOS	White Cap with Washer Seal	T550-10AT & -ATPR	No	1000
T552W	White Cap with Lip Seal	T552-5ATTP, -10ATTP, -12ATTP	No	1000
T552-7W*	White Cap with Lip Seal	7 ml tube	Yes	1000
T552-30W*	White Cap with Lip Seal	30 ml tube	Yes	500

\*Will accept a Color Coding Capinsert™a (see page 128 for further details)



**STERILE**

## T553

### Sterile Specimen Collection Tubes For Urinalysis



Tube made of polypropylene / Cap made of polyethylene

Simport Urinalysis Specimen Collection Tubes have a conical bottom to facilitate sample removal. Their design offers a skirted free-standing base. These graduated tubes contain a 75 mg tablet of boric acid in order to preserve urine specimens for up to 72 hours without refrigeration. Offered in two popular sizes. Amber color tubes are available for light sensitive specimens. A white leakproof screw cap is supplied on each tube along with a fill line label. Sterile.

Cat. #	Dimensions (mm)*	Graduations	Color	Volume	Qty/Cs
T553-10A	16.6 x 84	Etched on tube	Natural	10 ml	500
T553-10AA	16.6 x 84	Etched on tube	Amber	10 ml	500
T553-12A	16.6 x 102	Etched on tube	Natural	12 ml	500
T553-12AA	16.6 x 102	Etched on tube	Amber	12 ml	500

\*Dimensions include tube with cap

## T552TP

### Tamper Evident Self-Standing Non Sterile Transport Tubes



Tube made of polypropylene / Cap made of polyethylene

At last, a tamper evident sample and transport tube design, incorporating all the features and benefits of the Simport line of the sample tube family. They are ideal for all applications requiring a tamper evident seal in order to guarantee the utmost security and where sample integrity is of high importance:

- As a safer transport tube
- For secure short and long term storage
- In clinical trials
- As a perfect vial for containing expensive reagents in diagnostic kits

These unique transport tubes incorporate a seal that needs to be broken in order to open it, which leaves an obvious visual indication that the vial has been opened.

The ease of operation is due in part to the closure's unique frangible band design. This produces a combination tamper evident and resistant closure system that provides benefits of safety and peace of mind.

Manufactured from non-toxic polypropylene, these tubes provide strength and clarity and exhibit some unique design features. Five sizes are available from 5 to 30 ml. They have external threads to provide a smooth and uniform inner surface.

A perfect leakproof seal is obtained by the use of a specially designed flexible sealing lip inside the polyethylene closures. The cap also features a long skirt and a super fast thread design allowing them to be removed or sealed with a single turn.



If you **TRULY** care about your sample, let us help you **PROTECT** its integrity!



Bar Code printing available for products on this page. Contact Simport for more details.

#### Tamper Evident Tubes

Cat. #	Dimensions (mm)*	Graduations	Volume	Qty/Pk
T552-5ATTP	16.6 x 65	Etched on tube	5 ml	1000
T552-7ATTP	13.4 x 84	Non graduated	7 ml	1000
T552-10ATTP	16.6 x 84	Etched on tube	10 ml	1000
T552-12ATTP	16.6 x 102	Etched on tube	12 ml	1000
T552-30ATTP	25.3 x 111	Etched on tube	30 ml	5 Pk of 100 500/Cs

\*For dimensions only, cap is included but should be ordered separately

**SCREW CAPS SOLD SEPARATELY**

#### Tamper Evident Caps

Cat. #	Description	For Tubes	Qty/Pk
T552WTP	White Cap with Lip Seal	5, 10 and 12 ml	1000
T552-7WTP*	White Cap with Lip Seal	7 ml	1000
T552-30WTP*	White Cap with Lip Seal	30 ml	500

\*Will accept a Capinsert™



Graduations:

- T552-5ATTP: Every 0.5 ml from 1 to 5
- T552-10ATTP: Every 0.5 ml from 1 to 8.5
- T552-12ATTP: Every 0.5 ml from 1 to 10.5
- T552-30ATTP: Every 2.5 ml from 5 to 30

Note: T552-7ATTP is not graduated



These unique transport tubes and caps incorporate a ring that needs to be broken in order to open it, which leaves an obvious visual indication that the vial has been opened.



For color coding purposes, use a Capinsert™ on top of the closure. Ten different colors are available. (see T345 Series)

For more details and colors available please refer to page 128.



## T307 Q-Swab™



Made of polypropylene (cap for T307-10A made of polyethylene)

The Simport Q-Swab™ are self-standing but with round bottom. The cotton swab holds securely inside the screw cap, making it ideal for specimen collection and protection from contamination. The polypropylene tubes are translucent, making it easy to see through. The cap features an exclusive silicone washer fitted inside to ensure a positive seal at any temperature. Sterile. Non graduated.

Cat. #	Volume	Dimensions	Qty/Pk	Qty/Cs
T307-5A	5 ml	12.5 x 93 mm	100	500
T307-10A	10 ml	16.6 x 85 mm	50	500

# CENTRIFUGE TUBES



For Plug Caps, see T401-10 Series on page 131.

## T408 15 ml Centrifuge Tubes

Made of polystyrene and polypropylene

Suitable for general centrifugation, urinalysis procedures and serum separation. These conical bottom tubes are chemically clean and metal free, ready to use and uniform in size and shape, measuring 17 x 120 mm. Graduations are at 0.25, 0.5, 1.0, 2.5, 5, 10, 12 and 15 ml. Polystyrene tubes resist a centrifuge speed of 1200g while polypropylene tubes resist speeds of up to 3000g. For Plug Caps, see T401-10 Series on page 131.

Cat. #	Material	Size (mm)	Qty/Pk	Qty/Cs
T408	Polystyrene	17 x 120	100	1000
T408-1	Polystyrene	17 x 120	Bulk	1000
T408-2	Polypropylene	17 x 120	Bulk	1000



## T410 Urine Collection System

Tube made of polystyrene

The Simport Urine Collection System contains 100 disposable 15 ml heavy-wall polystyrene tubes, snap caps, self-adhesive identification labels, and 3 oz. plastic collection cups all packed in a plastic bag (5 bags per case). Urine tubes are made of virgin polystyrene and are free of any mold release agents, metals or additives that could contaminate samples. They are made of heavy wall construction, graduated at 1/4, 1/2, 1, 2 and every 2 ml thereafter up to 12 ml, and can be safely centrifuged at speeds up to 2000g. The tubes are flared at the top to make filling and drip-free pouring easier. Designed to allow the use of midget urinometers and reagent test strips requiring only 1/4 or 1/2 ml of sample. The use of Simport tight-fitting plastic caps makes these tubes suitable for transportation in pneumatic tube systems. Size of tube: 105 mm H x 21 mm dia.

Cat. #	Description	Qty/Cs
T410	Urine collection system	500
T410-1	Urine tubes only	500
T410-2	Caps only	1000
T410-3	Tubes & closures only	500



## T420 50 ml Centrifuge Tubes



Tubes made of either polystyrene or polypropylene  
Caps made of high density polyethylene

These centrifuge tubes are also useful for collecting and transporting biological specimens. Leakproof characteristics are ensured by a flat top plastic screw cap with an inner sealing lip. Tubes are made of translucent polypropylene or optically clear polystyrene with molded graduations from 2.5 to 50 ml. Polypropylene tubes can be autoclaved and will resist temperatures up to 121 °C; they will also resist acids, solvents and alkalies at room temperature. They withstand centrifugation speeds of 3000g. Polystyrene tubes can tolerate aqueous solutions of mild bases or weak acids, but not organic solvents, aromatic or chlorinated hydrocarbons, and they cannot be autoclaved. They withstand centrifugation speeds up to 1000g.

**Tubes are available in bags or in polypropylene racks for better protection during transport,** storage and for convenient laboratory use. Racks can hold up to 25 tubes. Tubes are supplied sterile with green caps or non sterile with yellow caps. External Diameter: 29 mm. Height: 118 mm.

Cat. #	Description	Material	Cap color	Packaging	Qty/Cs
T420-1	Sterile	Polystyrene	Green	Rack/25	500
T420-3	Sterile	Polypropylene	Green	Rack/25	500
T420-4	Sterile	Polypropylene	Green	Bags/25	500
T420-5	Non sterile	Polypropylene	Yellow	Rack/25	500
T420-6	Non sterile	Polystyrene	Yellow	Bulk	500
T420-7	Non sterile	Polypropylene	Yellow	Bulk	500

## S207

### SNAPTWIST® Scintillation Vials 6.5 ml

Made of polypropylene and high density polyethylene

This general purpose vial can be used for liquid scintillation counting, gamma counting, chromatography, sample storage and culturing. It will fit very nicely into the LKB and Packard Varisette counters. The shoulderless vial features a full width opening of 12.5 mm and the overall dimensions are 16 x 57 mm. The exclusive SNAPTWIST® closures are made of high-flow polypropylene and are a true time saver.

The vials can be securely sealed by simply snapping the caps on; removal of caps requires an easy 1/4 turn (twist). The ease with which these caps can be manipulated eliminates the danger of spillage associated with other push-on/pull-off caps. A built-in positive lock prevents the cap from popping off because of a small build-up of pressure in the vial. The quality of the sealing system is such that it is not necessary to tighten the closure with pressure to achieve a leakproof seal.

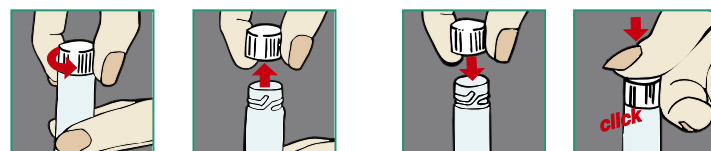

TO OPEN THE VIAL

TO CLOSE THE VIAL

Cat. #	Tube	Cap	Size (mm)	Qty/Cs
S207	Polyethylene	Polypropylene	16 x 57	1000
S207-5	Polypropylene	Polyethylene	16 x 57	1000



## S220

### Scintillation Vials 20 ml

Vial made of polypropylene / Cap made of high density polyethylene

This shoulderless vial features a full width opening of 23 mm for ease of access, a high degree of resistance to organic solvents, and sufficient translucence so that reagent levels or the presence of filter paper can be easily detected. The unique thread design of the closure allows the vial to be sealed, and opened with an easy 1/4 turn. The quality of the sealing system is such that it is not necessary to tighten the closure with a lot of pressure to achieve a leakproof seal. Polyethylene closure may not be autoclaved.

Cat. #	Volume (ml)	Size (mm)	Packaging	Qty/Cs
S220	20	26 x 61	Bulk	500
S220-1	20	26 x 61	Tray/100	500



## V130

### Dilution Vials

Made of polystyrene

With optically clear parallel sides. The snap cap is spill proof but easily removed. Guaranteed to meet or exceed O.E.M. specifications. Available in specially designed vacuum formed trays or in bulk packaging. Dimensions: 35 mm x 56 mm H Volume: 25 ml

Cat. #	Packaging	Qty/Cs
V130	Trays of 50 / 20 trays per case	1000
V130-1	Bulk pack	1000

# TUBE RACKS



## S500-80 The UniRack™

Made of polypropylene

On one side, the UniRack™ can hold up to 80 polystyrene or polypropylene 10 and 12 mm tubes, such as 10 x 75 mm or 12 x 75 mm sizes. This rack will accommodate all types of screw cap microtubes from 0.5 to 2 ml as well as 1 to 5 ml cryogenic vials. Flip the UniRack™ over and you can store up to 60 PCR or microcentrifuge tubes from 0.2 to 0.5 ml.

Units can be firmly anchored laterally to one another, thanks to special anchor pins supplied with each rack. This innovative concept will allow the user to store 80, 160, 240 and even 320 tubes of different shapes, sizes and volumes since the units can be attached to each other either on the 80- or 60- position side facing upward, thus ensuring maximum versatility.

It is supplied with two removable handles allowing for better safety characteristics. The handles of the lower rack make a perfect fit with those of the upper one, ensuring a stable unit which can easily and safely be moved around. An additional protection level is possible by using a very resistant and quite affordable transparent lid allowing a clear view of the contents.

There is a frosted area on both sides for bar coding, labeling or writing, enabling the user to identify the contents. It is easy to write on it with a felt-tip pen. Offered in a wide array of colors. Dimensions: 223 x 67 x 27 mm H (9 3/16 x 2 5/8 x 1 1/16 in. H)

Cat. #	Color	Qty/Cs	Cat. #	Color	Qty/Cs
S500-80B	Blue	10	S500-80R	Red	10
S500-80G	Green	10	S500-80Y	Yellow	10
S500-80O	Orange	10	S500-80AS	Assorted*	10
S500-80P	Pink	10			

\* Assorted colors : blue, green, orange, pink and yellow

Lid Cat. #	Color	Qty/Cs
S501-80	Transparent	10



The UniRack can also be placed at an angle for easier handling of tubes.

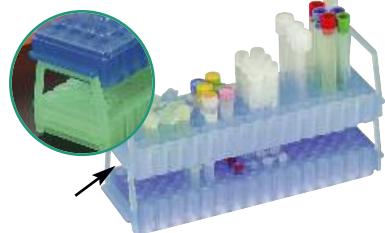

The handles of the lower rack make a perfect fit with those of the upper one, ensuring a stable unit which can easily and safely be moved around.

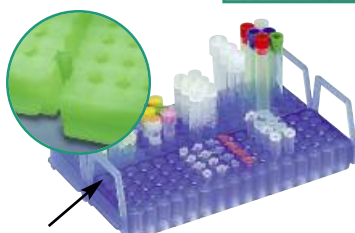

Units can be firmly anchored laterally to one another, thanks to special anchor pins supplied with each rack.

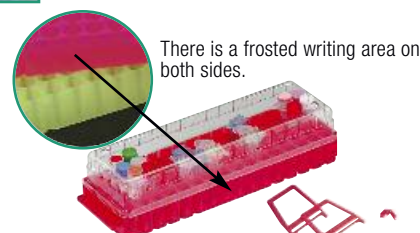

A transparent lid can be placed on the UniRack™, allowing a clear view of the contents.



## S500-25 The UniRack™ Jr.

Made of polypropylene

This smaller model of the UniRack can hold up to 25 polystyrene or polypropylene 10 and 12 mm tubes, such as 10 x 75 mm or 12 x 75 mm sizes. This rack will accommodate all types of screw cap microtubes from 0.5 to 2 ml made by manufacturers such as Simport, Sarstedt, Nalgene, Bio-Plas, SSI, Sorenson etc... as well as 1 to 5 ml cryogenic vials. Flip the UniRack™ over and you can store up to 16 PCR or microcentrifuge tubes from 0.2 to 0.5 ml. Supplied without handles or anchor pins.

Cat. #	Color	Qty/Cs
S500-25B	Blue	10
S500-25R	Red	10
S500-25Y	Yellow	10



## S510-500 The SecuRack™

Made of high impact polystyrene

This special 50-place rack will hold your 12 x 75 mm and 13 x 100 mm tubes securely in place thanks to silicone tabs surrounding the base of each tube while in the rack. This makes it very convenient to empty tube content before discarding them. Also great for holding tubes in rack securely in place when in a water bath. Each position is alpha numerically identified. Units can be anchored laterally to one another, thanks to two screws supplied with each rack. Dimensions: 250 x 128 x 50 mm H (9 3/4 x 5 x 2 in. H).



Silicone tabs around each opening securely hold tubes in place.



Cat. #	Color	Qty/Pk	Qty/Cs
S510-500	Orange	1	2



## S600 The MultiRack™

Made of acetal

A newly designed tube support that can be used all around the lab. The MultiRack™ is available in three models to accommodate a full range of laboratory test tubes and centrifuge tubes up to 30 mm in diameter. Although it is one of the most attractive racks available today, it offers all the advantages required by the modern laboratory. Made of highly resistant acetal, it will not shatter or stain in contact with most laboratory chemicals. No coating to worry about, which can chip, peel or rust in a water bath.

The MultiRack™ is compact, lightweight and stackable in order to save as much space as possible. This is why it is ideal for incubators, refrigerators, freezers, under lab hoods and on bench tops. Not only is it submersible but will also sink and maintain stability without tipping over.

The MultiRack™ is made of three-tiers to facilitate the insertion and stability of tubes. The base tier has rounded wells with drain holes. Convenient handles on each side of the rack will ensure a safe grip when carrying it around. Interlocking feet allow stacking. Series S600-13 will accommodate all tubes up to a diameter of 13 mm while series S600-16 will accept tubes up to 16 mm in diameter including 15 ml centrifuge tubes. Model S600-30 is perfect for accommodating up to 18 x 50 ml centrifuge tubes. Autoclavable at 121 °C for 20 minutes. Available in five attractive colors. Dimensions: 293 x 115 x 65 mm H (11 1/2 x 4 1/2 x 2 1/2 in. H)



## S610 The MultiRack™ Jr.



Made of acetal

Also available is the MultiRack™ Jr. having the same features and benefits as the larger model but will hold half the number of tubes. A great acquisition when space is more limited.



6 models available to accommodate a full range of laboratory tubes up to 30 mm in diameter.

Rack Cat. #	Capacity	Rack Cat. #	Capacity	For tubes	Color	Qty/Pk	Qty/Cs
S600-13B	84	S610-13B	42	up to 13 mm	Blue	1	10
S600-13G	84	S610-13B	42	up to 13 mm	Green	1	10
S600-13L	84	S610-13B	42	up to 13 mm	Lilac	1	10
S600-13O	84	S610-13B	42	up to 13 mm	Orange	1	10
S600-13Y	84	S610-13B	42	up to 13 mm	Yellow	1	10

Rack Cat. #	Capacity	Rack Cat. #	Capacity	For tubes	Color	Qty/Pk	Qty/Cs
S600-16B	60	S610-16B	30	up to 16 mm	Blue	1	10
S600-16G	60	S610-16B	30	up to 16 mm	Green	1	10
S600-16L	60	S610-16B	30	up to 16 mm	Lilac	1	10
S600-16O	60	S610-16B	30	up to 16 mm	Orange	1	10
S600-16Y	60	S610-16B	30	up to 16 mm	Yellow	1	10

Rack Cat. #	Capacity	Rack Cat. #	Capacity	For tubes	Color	Qty/Pk	Qty/Cs
S600-30B	18	S610-30B	9	25 to 30 mm	Blue	1	10
S600-30G	18	S610-30B	9	25 to 30 mm	Green	1	10
S600-30L	18	S610-30B	9	25 to 30 mm	Lilac	1	10
S600-30O	18	S610-30B	9	25 to 30 mm	Orange	1	10
S600-30Y	18	S610-30B	9	25 to 30 mm	Yellow	1	10

# STERILE BAGS

## TWIRL'EM® Sterile Sampling Bags

Labplas TWIRL'EM® Sterile Sampling Bags provide a secure, contaminant-free pliant container that ensures dependable analysis results. You can count on TWIRL'EM® products as a proven, economical and efficient way to collect, contain and carry samples. Our sterile bags are used for environmental sampling (surface samples), carcass sampling, biomedical and pharmaceutical research, quality assurance procedures (QA/QC), food industry applications and clinical and veterinary medicine.

Labplas TWIRL'EM® Sterile Sampling Bags comply with regulatory and industry requirements:

- EPA (US Environment Protection Agency)
- FDA (US Food and Drug Administration)
- USDA (US Department of Agriculture)
- HACCP (Hazard Analysis and Critical Control Point)

### CHARACTERISTICS

Labplas TWIRL'EM® Sterile Sampling Bags are made with highly resistant FDA approved virgin polyethylene tubing which eliminates side seals and ensures maximum bag mouth opening to facilitate sample insertion. The polyethylene tubing is extruded at 240 Celsius, which guaranties internal sterility. Equally important, the inside is never exposed to the environment during our production process.

TWIRL'EM® Sterile Sampling Bags are available in many sizes and wall thicknesses. We also manufacture both clear bags and bags with write-on strips.

TWIRL'EM® Sterile Sampling Bags come with a range of different closure systems: our standard version with two round wires; 1 round and 1 flat wire; or for large and heavy bags, a very strong closure consisting of 2 flat wires. TWIRL'EM® products are available with regular closure tabs or with safety tabs.

### Sterile Sampling Bags - Safety Tabs

#### Closure with 2 round wires, Clear

Cat. #	mil. in	micr.	Size (mm)	Volume (ml)	Packaging
EPL-3070	2.5	63	3 x 7 in. (76 x 178)	4 oz (130)	1000 (2 X 500)
EPL-3570	3.0	76	3.5 x 7 in. (89 x 178)	7 oz (210)	1000 (2 X 500)
EPL-4590	2.5	63	4.5 x 9 in. (114 x 229)	15 oz (450)	1000 (2 X 500)
EPL-5590	3.0	76	5.5 x 9 in. (140 x 229)	22 oz (650)	1000 (2 X 500)
EPL45590	4.0	101	5.5 x 9 in. (140 x 229)	22 oz (650)	1000 (2 X 500)
EPL-5515	3.0	76	5.5 x 15 in. (140 x 382)	50 oz (1500)	1000 (2 X 500)
EPL-7012	3.0	76	7 x 12 in. (178 x 305)	55 oz (1650)	1000 (4 X 250)
EPL47012	4.0	101	7 x 12 in. (178 x 305)	55 oz (1650)	1000 (4 X 250)
EPL-7015	3.0	76	7 x 15 in. (178 x 382)	85 oz (2500)	1000 (4 X 250)

#### Closure with 2 round wires, Printed

Cat. #	mil. in	micr.	Size (mm)	Volume (ml)	Packaging
EPR-3050	2.5	63	3 x 5 in. (76 x 127)	2 oz (60)	1000 (2 X 500)
EPR-3070	2.5	63	3 x 7 in. (76 x 178)	4 oz (130)	1000 (2 X 500)
EPR-3570	3.0	76	3.5 x 7 in. (89 x 178)	7 oz (210)	1000 (2 X 500)
EPR-4590	2.5	63	4.5 x 9 in. (114 x 229)	15 oz (450)	1000 (2 X 500)
EPR-5590	3.0	76	5.5 x 9 in. (140 x 229)	22 oz (650)	1000 (2 X 500)
EPR45590	4.0	101	5.5 x 9 in. (140 x 229)	22 oz (650)	1000 (2 X 500)
EPR-7012	3.0	76	7 x 12 in. (178 x 305)	55 oz (1650)	1000 (4 X 250)
EPR47012	4.0	101	7 x 12 in. (178 x 305)	55 oz (1650)	1000 (4 X 250)

#### Closure with 1 round and 1 flat wires, Clear

Cat. #	mil. in	micr.	Size (mm)	Volume oz (ml)	Packaging
EFL-4590	2.5	63	4.5 X 9 in. (114 X 229)	15 oz (450)	1000 (2 X 500)
EFL-5590	3.0	76	5.5 x 9 in. (140 x 229)	22 oz (650)	1000 (2 X 500)
EFL-5512	3.0	76	5.5 x 12 in. (140 x 305)	36 oz (1080)	1000 (2 X 500)
EFL-7012	3.0	76	7 x 12 in. (178 x 305)	55 oz (1650)	1000 (4 X 250)
EFL47012	4.0	101	7 x 12 in. (178 x 305)	55 oz (1650)	1000 (4 X 250)
EFL-1012	4.0	101	10 x 12 in. (254 x 305)	76 oz (2250)	1000 (4 X 250)
EFL-1015	4.0	101	10 x 15 in. (254 x 382)	135 oz (4000)	1000 (4 X 250)



#### Closure with 1 round and 1 flat wires, Printed

Cat. #	mil. in	micr.	Size (mm)	Volume (ml)	Packaging
EFR-3070	2.5	63	3 X 7 in. (76 x 178)	4 oz (130)	1000 (2 X 500)
EFR-4590	2.5	63	4.5 x 9 in. (114 x 229)	15 oz (450)	1000 (2 X 500)
EFR-5590	3.0	76	5.5 x 9 in. (140 x 229)	22 oz (650)	1000 (2 X 500)
EFR-7012	3.0	76	7 x 12 in. (178 x 305)	55 oz (1650)	1000 (4 X 250)
EFR47012	4.0	101	7 x 12 in. (178 x 305)	55 oz (1650)	1000 (4 X 250)
EFR-1012	4.0	101	10 x 12 in. (254 x 305)	76 oz (2250)	1000 (4 X 250)
EFR-1015	4.0	101	10 x 15 in. (254 x 382)	135 oz (4000)	1000 (4 X 250)

## Labplas Sterile Blender Bags

**SECURE-T**

### SECURE-T® Blender Bags

*Sterility at its best!*  
*Now available with a vertical write-on strip!*

Labplas SECURE-T® Blender Bags provide a malleable yet durable and contaminant-free container for the even blending of your samples. Uniform sample distribution ensures that your extraction is an accurate subset of your original sample. Applications vary from general blending purposes to sample preparation for analysis testing.

Our new optional vertical write-on strip makes it easy to label the bag for storage and you can still see the entire length of the contents.

The SECURE-T® product is available with standard 3 thousandths of an inch or optional 4 thousandths of an inch wall thickness, made to handle the most robust blending applications. We use heat extruded virgin polyethylene tubing which guarantees internal sterility and eliminates the need for side seals. In addition to superior wall strength, SECURE-T® blender bags have a patented sterile barrier tear-off top which ensures internal sterility right up until the time of use. SECURE-T® bags are available for all size blenders.

### Open Top Sterile Blender bags -

Labplas also manufactures standard Open Top Blender Bags. These products are also made with extruded polyethylene plastic tubing and have no side seals. They come in a case of 1000 units which is subdivided into packages of 250. Our standard Blender Bags undergo gamma ray sterilisation and have no side seals. Our Blender Bags are also available with the new, optional write-on strip.

### SECURE-T with Tear-Off Protection Strip - Clear

Cat. #	mil. in	micr.	Size (mm)	Volume (ml)	Packaging
SCL-4060	3.0	76	4 x 6 in. (102 x 152)	7.0 oz (205)	1000 (4 x 250)
SCL-7012	3.0	76	7 x 12 in. (178 x 305)	55 oz (1650)	1000 (4 x 250)
SCL47012	4.0	101	7 x 12 in. (178 x 305)	55 oz (1650)	1000 (4 x 250)
SCL41214	4.0	101	12 x 14 in. (305 x 356)	151 oz (4.5 L)	500 (2 x 250)
SCL-1520	3.0	76	15 x 20 in. (381 x 508)	405 oz (12 L)	500 (2 x 250)
SCL41520	4.0	101	15 x 20 in. (381 x 508)	405 oz (12 L)	500 (2 x 250)

Cat. #	mil. in	micr.	Size (mm)	Volume (ml)	Packaging
SCR-7012	3.0	76	7 x 12 in. (178 x 305)	55 oz (1650)	1000 (4 x 250)

### Secure-T / Sterile Blender Bags -Open Top

Cat. #	mil. in	micr.	Size (mm)	Volume (ml)	Packaging
SCL07012	3.0	76	7 x 12 in. (178 x 305)	55 oz (1650)	1000 (4 x 250)
SCL01520	3.0	76	15 x 20 in. (381 x 508)	405oz (12 L)	500 (2 x 250)
SCR07012	3.0	76	7 x 12 in. (178 x 305)	55 oz (1650)	1000 (4 x 250)

### FILTRA- BAG® - Strength and Precision Every Time!

Labplas FILTRA-BAG® Blender Bags are designed to simplify taking an aliquot when working with samples which contain large amounts of residue and/or semi-solid/solid substances. When placing an aliquot onto growth media, it's very important that the volume of the aliquot be accurate and that it be free of solid particles. This prevents pipette blockage as well as uneven plate distribution.

The FILTRA-BAG® was designed for compact samples that need to be liquefied and strained. That is why the bag is made with a polyethylene/polyester (PET) outer shell which practically eliminates the possibility of piercing the bag wall during blending. In addition, one of the walls has FILTRA-BAG® to differentiate the individual compartments, therefore simplifying how to identify which side the aliquot should be taken from after blending. Most protocols indicate that the sample be inserted in the logo side, so the aliquot is extracted from the clear side after blending.

The dividing filter membrane has 1840 holes per square inch with a pore size of 330 microns. This pore size has proven to be very effective for the majority of applications and allows for optimal solution and bacterial flow between the FILTRA-BAG® compartments during blending.

### FILTRA BAG / Filtra Bags for Blender

Cat. #	mil. in	micr.	Size (mm)	Volume (ml)	Packaging
SCT-6090A	3.0	76	6 x 9 in. (152 x 229)	24 oz (710)	400 (4 x 100)
SCT07012A	3.0	76	7 x 12 in. (178 x 305)	55 oz (1650)	400 (4 x 100)
SCT-1015A	3.0	76	10 x 15 in. (254 x 381)	92 oz (2720)	200 (2 x 100)
EFT-7012A	3.0	76	15 x 20 in. (381 x 508)	405 oz (12 L)	400 (4 x 100)

# STERILE BAGS



## Surface Sampling Kits: Sani-Sponge

The Labplas SANI-SPONGE kit is designed to collect samples to detect the presence of microbiological contaminations such as Listeria, Salmonella, E. coli, and other food-borne pathogens on almost any surface. These kits are widely used in the food, public health and cosmetic industries. The SANI-SPONGE kit is convenient and easy to use, and helps eliminate several time-consuming steps.

Labplas SANI-SPONGE sampling kits are produced in accordance with HACCP, USDA, ACIA and CFIA requirements.

Labplas SANI-SPONGE Sampling Kits come in two forms:

### Dry Sponge

TWIRL'EM® Sterile Sampling bag with write-on strip containing a dry biocide-free cellulose sponge (1.5 x 3 x 5/8 in. when hydrated)

### Wet Sponge

TWIRL'EM® Sterile Sampling bag including pre-moistened cellulose sponge, holding 10 ml of the buffer of your choice (Neutralizing buffer-sterile, DE Neutralizing buffer-sterile, Buffered peptone water-sterile)

All Labplas SANI-SPONGE TWIRL'EM® bags come with safety tabs. The puncture-proof tabs eliminate the sharp points that can cause bag puncture and/or abrasions.

SANI-SPONGE kits are sterilized using gamma irradiation.

## KSS-6110

SANI-SPONGE with dehydrated sponge:

- 1- Tear off the top of bag along the perforation.
- 2- Use pull-tabs to pull open the bag.
- 3- Hydrate sponge with buffer prior to removing it from the bag.
- 4- Take a sample by wiping the test surface with the hydrated sponge; put the sponge back into the bag when done.
- 5- Hold bags by wire ends and swirl 3 to 4 times too close, fold wire ends inward onto bag.

Cat. #	Description	mil. in	micr.	Size (mm)	Volume (ml)	Packaging
KSS-61110	Dehydrated sponge	2.5	63	4.5x9in. (114x229)	15 oz (450)	400 (4 X 100)
KSS-61105	Dehydrated sponge with gloves	2.5	63	4.5x9in. (114x229)	15 oz (450)	400 (4 X 100)
KSS-61110-NE	Hydrated sponge with gloves	2.5	63	4.5x9in. (114x229)	15 oz (450)	100 (5 X 20)
KSS-61110-DE	Hydrated sponge with gloves	2.5	63	4.5x9in. (114x229)	15 oz (450)	100 (5 X 20)
KSS-61110-PW	Hydrated sponge with gloves	2.5	63	4.5x9in. (114x229)	15 oz (450)	100 (5 X 20)

## Water Sampling Kits

*No more expensive rigid containers!*



the insertion of water sample, a convenient write-on strip and volume markings for measurements.

All Labplas Water Sampling kit TWIRL'EM® bags come with safety tabs. The puncture-proof tabs eliminate the sharp points that can cause bag puncture and/or abrasions.

Labplas Water Sampling kits are sterilized using gamma irradiation.

Labplas Water Sampling kits provide a quick and convenient way to collect chlorinated water specimens. Our sterile Water Sampling kits contain a nontoxic, nutritive tablet containing 10 mg of active sodium thiosulphate and are UPA-approved for drinking water analysis. The sodium thiosulphate instantly neutralizes halogen compounds (in this case chlorine) and enables effective bacterial or organic testing.

Labplas Water Sampling kits are designed to collect, carry and contain chlorinated water samples in aseptic conditions and are an economical and efficient alternative to rigid sampling containers.

### Characteristics:

Labplas Water Sampling kits are made with highly resistant FDA-approved polyethylene. Key features are: maximum bag mouth opening to facilitate

Cat. #	Sodium Thiosulfate Tablet	mil. in	micr.	Size (mm)	Volume oz (ml)	Packaging
KWS-21100	1 x 10 mg	2.5	63	3x7 in. (76x178)	4 oz (100)	Cs/100
KWS-22200	3 x 10 mg	2.5	63	4.5x9 in. (114x229)	10 oz (300)	Cs/100

# Chemical and Physical Properties

## Chemical Resistance and Physical Properties of Plastics

ABS: Acrylonitrile Butadiene Styrene  
 Acetal: Polyoxymethylene  
 EVA: Ethylene Vinyl Acetate  
 HDPE: High-density polyethylene  
 HIPS: High-Impact Polystyrene

LDPE: Low-density polyethylene  
 PC: Polycarbonate  
 PP: Polypropylene  
 PS: Polystyrene  
 PVC: Polyvinyl Chloride

## Chemical Resistance Summary

Resin	Max use temp (°F/°C)	Brittleness temp (°F/°C)	Transparency	Sterilization					Specific gravity (g/mL)	Flexibility	Permeability (approximate) cc-mm m <sup>2</sup> -24hr-Bar			Water absorption (%)
				Autoclave	Gas	Dry heat	Radiation	Disinfectants			N <sub>2</sub>	O <sub>2</sub>	CO <sub>2</sub>	
HDPE	248/120	-148/-100	Translucent	No	Yes	No	Yes	Yes	0.95	Rigid	651	2868	8990	<0.01
LDPE	176/80	-148/-100	Translucent	No	Yes	No	Yes	Yes	0.92	Excellent	2790	7750	41,850	<0.01
PC	275/135	-211/-135	Transparent	Yes	Yes	No	Yes	Yes	1.20	Rigid	775	4650	16,663	0.35
PP	275/135	32/0	Translucent	Yes	Yes	No	No	Yes	0.90	Rigid	744	3720	12,400	<0.02
PS	194/90	68/20	Transparent	No	Yes	No	Yes	Some	1.05	Rigid	853	4650	17,825	0.05
PVC	158-70	-22/-30	Transparent	No	Yes	No	No	Yes	1.34	Rigid	31-310	62	62	0.15-0.75

## Physical Properties

Classes of substances; temperature 20 °C	LDPE	HDPE	PC	PP	PS	PVC
Acids, weak or dilute	E	E	E	E	E	E
Acids, strong or concentrated	E	E	G	E	E	E
Alcohols, aliphatic	E	E	G	E	E	E
Aldehydes	G	G	F	G	N	N
Bases	E	E	N	E	E	E
Esters	G	G	N	G	N	N
Hydrocarbons, aliphatic	G	F	F	G	N	E
Hydrocarbons, aromatic	G	F	N	F	N	N
Hydrocarbons, halogenated	F	N	N	F	N	N
Ketones	G	G	N	G	N	N
Oxidizing agents, strong	F	F	N	F	N	G

**E - No damage** after 30 days of constant exposure.

**G - Little or no damage** after 30 days of constant exposure.

**F - Some effect** after seven days of constant exposure. Depending on the plastic, the effect may be cracking, crazing, loss of strength, discoloration. Solvents may cause softening, swelling, and permeation losses with PPCO, PP, PMP, LDPE, and HDPE; the solvent effects on these materials are normally reversible.

**N - Not recommended** for continuous use. Immediate damage may occur. Depending on the plastic, the effect will be severe cracking, crazing, loss of strength, discoloration, deformation, dissolution, or permeation loss.

# Chemical Resistance Chart

Reagent	ABS	Acetal	HDPE	LDPE	PC	PP	Santo-prene	Sili-cone	Reagent	ABS	Acetal	HDPE	LDPE	PC	PP	Santo-prene	Sili-cone
Acetaldehyde	D	A	C	C	C <sup>1</sup>	A <sup>1</sup>	—	A	Benzene	D	A <sup>1</sup>	D	D	D	D	D	D
Acetamide	—	A	A	A	D	A <sup>1</sup>	—	B	Benzene Sulfonic Acid	—	—	A	A <sup>1</sup>	D	D	—	D
Acetate Solvent	—	—	A	A	—	B <sup>1</sup>	—	C	Benzoic Acid	—	B	A	A <sup>1</sup>	B <sup>1</sup>	B <sup>1</sup>	—	D
Acetic Acid	D	D	A	A <sup>2</sup>	B <sup>1</sup>	B	A	C	Benzol	D	A	—	C <sup>1</sup>	D	B	D	D
Acetic Acid 20%	C	C	A	A	A <sup>1</sup>	A	A	B	Benzonitrile	—	—	—	—	A <sup>1</sup>	—	—	A <sup>1</sup>
Acetic Acid 80%	D	D	A	D	B <sup>1</sup>	A	C	B	Benzyl Chloride	D	A	—	—	—	C <sup>1</sup>	—	D
Acetic Acid, Glacial	D	A	D	B <sup>1</sup>	A <sup>1</sup>	D	B	—	Bleach	B	D	—	—	—	D	—	—
Acetic Acid, Vapors	—	—	—	—	—	—	—	A	Bleaching Liquors	—	—	—	A <sup>1</sup>	—	A <sup>1</sup>	—	B
Acetic Anhydride	C1	D	C	D	D	B <sup>1</sup>	D	C	Borax (Sodium Borate)	—	B	A	A <sup>2</sup>	—	B	—	B
Acetone, 50% water	D	—	—	—	—	A	—	A <sup>2</sup>	Boric Acid	—	A	A	A <sup>2</sup>	—	A	A	A
Acetone	D	A	D	B <sup>1</sup>	D	A	A	D	Bromine Slop	—	B	—	—	—	—	—	—
Acetonitrile	D	—	A	A	D	A <sup>1</sup>	D	D	Bromine	D	D	D	D	C <sup>1</sup>	D	—	D
Acetophenone	—	—	C	D	D	C	—	—	Bromoform	—	—	D	D	D	D	—	—
Acetyl Bromide	—	—	—	D	D	—	—	—	Butadiene	—	A	D	D	D	C	—	D
Acetyl Chloride (dry)	D	D	—	D	D	D	A	C	Butane	B	A	—	C <sup>1</sup>	D	A <sup>1</sup>	—	D
Acetylene	—	A	—	D	D	A <sup>1</sup>	—	B	Butanol (Butyl Alcohol)	—	A	—	B <sup>2</sup>	B <sup>1</sup>	A <sup>1</sup>	—	B
Acrylonitrile	D	—	A	A	D	A <sup>1</sup>	D	D	Butter	B	A	—	—	—	D	—	B
Adipic Acid	—	—	A	A	—	B <sup>2</sup>	—	—	Buttermilk	B	A	—	A <sup>1</sup>	A <sup>1</sup>	A <sup>1</sup>	—	A
Alanine	—	—	A	A	A	A	—	—	Butyl Amine	—	C <sup>1</sup>	—	C <sup>1</sup>	D	B <sup>1</sup>	—	B <sup>1</sup>
Alcohols :									Butyl Ether	—	D	—	—	—	D	—	D
- Amyl	A <sup>1</sup>	A	A	B <sup>2</sup>	B <sup>1</sup>	B <sup>1</sup>	A	D	Butyl Phthalate	—	—	A	C <sup>1</sup>	D	B <sup>2</sup>	—	A <sup>1</sup>
- Benzyl	D	A	B	D	—	A	D	—	Butyl acetate	—	A	B	C <sup>1</sup>	D	B <sup>1</sup>	—	D
- Butyl	A <sup>1</sup>	A	—	A	A <sup>2</sup>	A	B	B	Butylene	—	A	—	B <sup>1</sup>	D	—	—	D
- Diacetone	—	A	A	B <sup>1</sup>	—	B <sup>2</sup>	—	D	Butyric Acid	D	A	D	D	D	B <sup>1</sup>	A	D
- Ethyl	B <sup>1</sup>	A <sup>1</sup>	A	B	B <sup>2</sup>	A	A	B	Calcium Bisulfate	—	—	—	—	—	—	—	C
- Hexyl	—	A	—	A	—	—	—	B	Calcium Bisulfide	—	D	—	B <sup>1</sup>	—	A	—	C
- Isobutyl	B	A	A	A <sup>2</sup>	—	A <sup>1</sup>	—	A	Calcium Bisulfite	—	D	A	A <sup>1</sup>	D	A	—	A
- Isopropyl	—	A	A	A <sup>2</sup>	A <sup>2</sup>	A <sup>2</sup>	—	A	Calcium Bromide 38%	—	—	—	—	—	—	—	—
- Methyl	D	A	A	A <sup>1</sup>	B <sup>1</sup>	A <sup>2</sup>	A	A	Calcium Carbonate	—	A	—	B <sup>1</sup>	C <sup>2</sup>	A	—	A
- Octyl	A <sup>1</sup>	A	—	—	—	—	—	B	Calcium Chlorate	—	A	—	—	—	—	—	—
- Propyl	B <sup>1</sup>	A	—	A <sup>2</sup>	—	A	A	A	Calcium Chloride (30% in water)	B	D	A	B <sup>2</sup>	—	A <sup>2</sup>	—	A
Allyl Chloride	D	—	A	—	—	A	—	—	Calcium Chloride (saturated)	A	D	A	—	—	A	—	A
Aluminium Acetate (saturated)	—	—	—	—	—	A	—	D	Calcium Fluoride	—	—	—	—	—	—	—	—
Aluminium Chloride	A	—	A	B <sup>2</sup>	A <sup>1</sup>	A	—	B	Calcium Hydroxide 10%	—	A	A	—	—	A	—	A
Aluminium Chloride 20%	—	C	A	B <sup>2</sup>	A <sup>1</sup>	A	—	B	Calcium Hydroxide (saturated)	A	—	A	—	—	A	—	A
Aluminium Fluoride	A	C	A	A <sup>2</sup>	—	A	—	B	Calcium Hydroxide	—	D	A	A <sup>2</sup>	D	A <sup>2</sup>	—	A
Aluminium Hydroxide	B	A	A	A <sup>2</sup>	B <sup>1</sup>	A	—	—	Calcium Hypochlorite 30%	—	—	A	—	—	A	—	—
Aluminium Nitrate	—	B <sup>1</sup>	—	A <sup>2</sup>	A <sup>1</sup>	A <sup>2</sup>	—	B	Calcium Hypochlorite (saturated)	A	—	A	—	—	A	—	—
Aluminium Phosphate	—	—	—	—	—	—	—	A	Calcium Hypochlorite	—	D	A	A <sup>1</sup>	D	A <sup>1</sup>	—	B
Aluminium Potassium Sulfate 10%	—	C	A	A <sup>2</sup>	A <sup>1</sup>	A	—	A	Calcium Nitrate	A	D	B	A <sup>1</sup>	A <sup>2</sup>	A <sup>2</sup>	—	B <sup>1</sup>
Aluminium Potassium Sulfate 100%	—	C	A	A <sup>2</sup>	A <sup>2</sup>	A	—	A	Calcium Oxide	D	A	—	B <sup>1</sup>	—	A	—	A
Aluminium Sulfate	A <sup>2</sup>	B <sup>1</sup>	A	A <sup>2</sup>	A	A	A	A	Calcium Sulfate	C	D	—	B <sup>1</sup>	A <sup>2</sup>	A	—	—
Alums	—	—	—	A	—	A	—	A <sup>1</sup>	Calcium Sulfide	—	—	—	—	—	A	—	—
Amines	—	D	B	C <sup>1</sup>	—	B <sup>2</sup>	—	B	Calgon	—	A	—	—	—	A	—	A
Ammonia 10%	—	D	A	C <sup>1</sup>	D	A <sup>2</sup>	—	—	Cane Juice	—	A	—	—	—	C <sup>1</sup>	—	A
Ammonia Nitrate	—	C	—	A	—	A	—	—	Carbolic Acid (Phenol)	D	D	—	D	D	B	—	D
Ammonia, anhydrous	D	D	A	B <sup>2</sup>	D	A	—	C	Carbon Bisulfide	—	A	—	—	—	D	—	—
Ammonia, liquid	—	D	A	C <sup>1</sup>	D	A <sup>2</sup>	—	—	Carbon Dioxide (dry)	B	A	—	A <sup>1</sup>	—	A <sup>2</sup>	—	B
Ammonium Acetate	—	—	A	A	—	A	—	—	Carbon Dioxide (wet)	B	A	—	A <sup>1</sup>	—	A <sup>2</sup>	—	B
Ammonium Bifluoride	A <sup>2</sup>	D	—	A <sup>2</sup>	—	A	—	—	Carbon Disulfide	—	—	D	D	D	D	—	—
Ammonium Carbonate	A <sup>2</sup>	D	B	B <sup>2</sup>	—	A	—	C	Carbon Monoxide	—	A	—	A <sup>2</sup>	—	A	—	A <sup>2</sup>
Ammonium Caseinate	—	D	—	—	—	—	—	—	Carbon Tetrachloride	D	B <sup>1</sup>	C	D	D	D	—	D
Ammonium Chloride	A <sup>2</sup>	B	A	A <sup>2</sup>	A <sup>2</sup>	A	—	C	Carbon Tetrachloride (dry)	D	—	C	D	—	D	—	D
Ammonium Fluoride 25%	D	—	A	—	—	A <sup>4</sup>	—	—	Carbon Tetrachloride (wet)	D	A <sup>1</sup>	C	—	D	D	—	D
Ammonium Hydroxide	B	C	A	A <sup>1</sup>	D	A	—	A	Carbonated Water	—	A	—	A	—	B	—	—
Ammonium Glycolate	—	—	A	A	B	A	—	—	Carbonic Acid	—	B <sup>1</sup>	B	B <sup>2</sup>	A <sup>1</sup>	A	—	A
Ammonium Nitrate	—	A <sup>2</sup>	A	A <sup>1</sup>	—	A	—	—	Catsup	B	B	—	—	—	A	—	—
Ammonium Oxalate	—	B	A	—	A <sup>1</sup>	A	—	—	Cellulose Acetate	—	—	—	—	—	A	—	—
Ammonium Persulfate	A <sup>2</sup>	D	A	A <sup>2</sup>	—	A	—	D	Chloral Hydrate	A	—	D	—	—	D	—	—
Ammonium Phosphate, Dibasic	A <sup>2</sup>	B <sup>2</sup>	—	A <sup>2</sup>	A <sup>2</sup>	A	—	A	Chloric Acid	—	D	—	—	—	—	—	—
Ammonium Phosphate, Monobasic	—	B	—	A	—	A	—	A	Chlorinated Glue	—	D	—	—	—	—	—	—
Ammonium Phosphate, Tribasic	—	B	—	C	—	A	—	A	Chlorine Water	—	D	C	B <sup>1</sup>	—	D	—	D
Ammonium Sulfate	A <sup>2</sup>	B <sup>1</sup>	A	A <sup>1</sup>	A <sup>2</sup>	A	—	A	Chlorine Anhydrous Liquid	—	A <sup>1</sup>	C	D	C	D	—	D
Ammonium Sulfite	—	D	B	B <sup>2</sup>	—	A	—	—	Chlorine (dry)	—	D	B	D	—	D	—	D
Ammonium Thiosulfate	—	B	—	A	—	—	—	—	Chloroacetic Acid	—	D	A	D	D	C <sup>1</sup>	D	D
Amyl Acetate	D	B <sup>1</sup>	—	C <sup>1</sup>	D	B <sup>1</sup>	D	D	Chlorobenzene (Mono)	D	D	D	C <sup>1</sup>	D	C <sup>1</sup>	D	D
Amyl Alcohol	A <sup>1</sup>	A	A	B <sup>2</sup>	B <sup>1</sup>	B <sup>1</sup>	A	D	Chlorobromomethane	—	—	—	A	—	A	—	D
Amyl Chloride	D	A	B	D	—	D	—	D	Chloroform	D	A	D	C <sup>1</sup>	D	C <sup>1</sup>	D	D
Aniline	D	A <sup>1</sup>	B	C	D	A <sup>1</sup>	D	B	Chlorosulfonic Acid	—	D	D	D	C <sup>1</sup>	D	—	D
Aniline Chlorohydrate	—	—	—	—	—	—	—	—	Chocolate Syrup	—	A	—	—	A	—	—	—
Aniline Hydrochloride	D	—	—	D	D	D	—	D	Chromic Acid 5%	B	D	A	A	B	D	D	C
Antifreeze	B	D	—	—	—	D	—	C	Chromic Acid 10%	B	D	A	A	B	D	D	C
Antimony Trichloride	A <sup>2</sup>	—	B	B <sup>2</sup>	A <sup>2</sup>	A	A	—	Chromic Acid 30%	B	D	A	A	C	D	D	C
Aqua Regia (80% HCl, 20% HNO <sub>3</sub> )	D	D	D	B <sup>1</sup>	D	D	D	D	Chromic Acid 50%	D	D	A	A	D	D	D	C
Arochlor 1248	—	—	—	C <sup>1</sup>	—	D	—	B	Chromium Salts	—	—	—	B	—	—	—	—
Aromatic Hydrocarbons	—	A	—	C	—	D	—	D	Cider	—	A	—	B	A	A	—	B <sup>1</sup>
Arsenic Acid	A <sup>2</sup>	D	B	B <sup>2</sup>	A <sup>1</sup>	A	B	A	Citric Acid	D	B <sup>1</sup>	A	D	A <sup>1</sup>	A	A	A
Arsenic Salts	—	—	—	B	—	—	—	—	Citric Oils	—	B	B	—	—	A	—	—
Asphalt	—	B <sup>2</sup>	—	A <sup>1</sup>	D	B <sup>1</sup>	—	D	Coffee	—	A	—	—	—	A	—	A
Barium Carbonate	A <sup>2</sup>	A	—	B <sup>2</sup>	A <sup>2</sup>	A	—	—	Copper Chloride	A	A	—	—	—	A	—	A <sup>1</sup>
Barium Chloride	A <sup>2</sup>	A	B	A <sup>1</sup>	A	A	—	A	Copper Cyanide	—	A	—	B <sup>2</sup>	D	A	—	A
Barium Cyanide	—	B	—	B	D	—	—	—	Copper Fluoborate	—	B	—	—	—	—	—	—
Barium Hydroxide	A <sup>2</sup>	D	—	B <sup>2</sup>	D	B	—	A	Copper Nitrate	—	A	—	B <sup>2</sup>	D	A	—	—
Barium Nitrate	—	B <sup>2</sup>	—	B <sup>2</sup>	D	A	—	B	Copper Sulfate 5%	—	D	A	A <sup>2</sup>	A <sup>1</sup>	A	—	A
Barium Sulfate	A <sup>2</sup>	B <sup>2</sup>	B	B <sup>2</sup>	D	B <sup>1</sup>	—	A	Copper Sulfate >5%	—	D	A	A <sup>2</sup>	A <sup>1</sup>	A	—	A
Barium Sulfide	A <sup>2</sup>	A	A	B <sup>2</sup>	—	B	—	A	Cream	—	A	—	—	—	A	—	—
Beer	A <sup>2</sup>	A <sup>1</sup>	A	A <sup>2</sup>	A <sup>2</sup>	A <sup>1</sup>	—	A	Creosote	A	D	A	—	—	—	—	D
Beet Sugar Liquids	B	B	—	A <sup>1</sup>	—	A <sup>1</sup>	—	A	Cresols	D	D	D	C <sup>1</sup>	D	D	—	D
Benzaldehyde	B	A	B	A <sup>1</sup>	D	D	D	D									
Benzenamine	—	—	B	A	D	A	—	—									

# Chemical Resistance Chart

Reagent	ABS	Acetal	HDPE	LDPE	PC	PP	Santo-prene	Sili-cone	Reagent	ABS	Acetal	HDPE	LDPE	PC	PP	Santo-prene	Sili-cone
Cresylic Acid	-	D	-	B <sup>1</sup>	D	A <sup>1</sup>	-	A	Hydrofluoric Acid 75%	C	D	B	C <sup>1</sup>	D	C <sup>1</sup>	D	D
Cupric Acid	-	-	-	B <sup>1</sup>	A <sup>1</sup>	A <sup>2</sup>	-	A <sup>1</sup>	Hydrofluoric Acid 100%	D	D	D	-	D	C <sup>1</sup>	D	D
Cyanic Acid	-	D	-	-	-	-	-	A <sup>1</sup>	Hydrofluosilicic Acid 20%	-	B	B	B <sup>2</sup>	-	A	-	D
Cyclohexane	-	A	D	B <sup>1</sup>	B	D	D	D	Hydrofluosilicic Acid 100%	-	A	C	B <sup>1</sup>	-	A	-	D
Cyclohexanone	D	A <sup>1</sup>	B	D	D	D	D	D	Hydrogen Gas	-	-	A	A <sup>2</sup>	A <sup>2</sup>	A	-	C
Detergents	B	A <sup>1</sup>	A	D	A <sup>1</sup>	A	-	A	Hydrogen Peroxide 10%	A	D	A	A	A <sup>2</sup>	A	-	A
Dextrin	A	-	A	-	-	A	-	-	Hydrogen Peroxide 30%	-	D	A	C <sup>2</sup>	A <sup>2</sup>	B <sup>1</sup>	-	B
Dextrose	A	-	A	-	-	A	-	A	Hydrogen Peroxide 50%	-	D	A	C <sup>2</sup>	A <sup>2</sup>	B <sup>1</sup>	-	B
Diacetone Alcohol	-	-	A	A	D	A <sup>1</sup>	-	D	Hydrogen Peroxide 100%	A	D	A	C <sup>2</sup>	A	B <sup>1</sup>	-	B
Dibenzyl Ether-	-	-	-	-	-	-	-	-	Hydrogen Sulfide (aqua)	B	C	A	A	A	A <sup>1</sup>	-	C
Dichlorobenzene	D	-	-	-	D	C <sup>1</sup>	D	D	Hydrogen Sulfide (dry)	-	-	A	A	-	A <sup>1</sup>	-	C
Dichloroethane	D	A <sup>1</sup>	C	C <sup>1</sup>	D	D	D	D	Hydroquinone	D	A	-	A	-	A	-	-
Diesel Fuel	-	A	D	C <sup>1</sup>	A <sup>2</sup>	A <sup>1</sup>	B	D	Ink	A	B	-	-	-	-	-	-
Diethyl Ether	D	-	D	-	D	A <sup>1</sup>	A	D	Hydroxyacetic Acid 70%	-	A	-	A	-	-	-	-
Diethylamine	D	B	D	D	D	A <sup>1</sup>	-	B	Iodine	D	D	B	A <sup>1</sup>	-	C	-	-
Diethylene Glycol	B	A <sup>1</sup>	A	B <sup>2</sup>	B <sup>1</sup>	A <sup>2</sup>	A	B <sup>1</sup>	Iodine (in alcohol)	-	D	B	B	-	-	-	-
Dimethyl Aniline	D	D	B	-	D	D	-	D	Iodoform	-	-	-	-	-	-	-	-
Dimethyl Ether	-	-	-	-	-	-	-	A	Isooctane	-	-	B	B	B <sup>1</sup>	A <sup>2</sup>	D	D
Dimethyl Formamide	D	D	A	A	D	A	A	C	Isopropyl Acetate	-	D	B	B <sup>1</sup>	D	B <sup>1</sup>	-	D
Diphenyl	-	-	-	-	-	D	-	D	Isopropyl Ether	-	D	D	B	D	B	-	D
Diphenyl Oxide	-	D	-	-	-	D	-	C	Isotane	-	-	-	-	-	D	-	-
Disodium Phosphate	A	-	A	-	-	A	-	-	Jet Fuel (JP3, JP4, JP5, JP8)	-	A <sup>1</sup>	D	D	A <sup>1</sup>	A <sup>1</sup>	D	D
Dyes	-	C	-	-	-	-	-	-	Kerosene	D	A <sup>2</sup>	B	C <sup>1</sup>	D	B	D	D
Epson Salts (Magnesium Sulfate)	B <sup>2</sup>	B	-	A <sup>2</sup>	A <sup>1</sup>	A	-	A	Ketones	A	D	D	C <sup>1</sup>	D	C	D	-
Ethane	-	A <sup>1</sup>	-	-	-	D	-	D	Lacquer Thinners	A	D	D	A	B	D	-	D
Ethanol	B <sup>1</sup>	A <sup>1</sup>	A	B	B <sup>2</sup>	A	A	B	Lacquers	A	D	D	A	D	D	-	D
Ethanolamine	-	D	-	-	-	D	-	B	Lactic Acid	D	B	A	A <sup>1</sup>	B	B	-	A
Ether	D	A <sup>1</sup>	D	D	-	D	-	D	Lard	-	A	A	A	A <sup>1</sup>	B <sup>1</sup>	A	A
Ethyl Acetate	D	A	A	A	D	A <sup>1</sup>	A	B	Latex	B	B	-	-	-	A <sup>2</sup>	-	B
Ethyl Benzoate	D	-	B	C <sup>2</sup>	D	B <sup>1</sup>	-	D	Lead Acetate	B	B	A	A <sup>2</sup>	-	A <sup>1</sup>	-	A
Ethyl Chloride	D	A <sup>1</sup>	C	C <sup>1</sup>	D	D	D	D	Lead Nitrate	B	-	A	A <sup>2</sup>	-	A <sup>2</sup>	-	B <sup>1</sup>
Ethyl Ether	D	A <sup>1</sup>	D	D	-	D	-	D	Lead Sulfamate	-	A	-	A <sup>1</sup>	A <sup>1</sup>	A <sup>2</sup>	-	B
Ethyl Sulfate	-	-	-	-	-	-	-	-	Ligroin	-	B	-	A	-	A <sup>2</sup>	-	D
Ethylene Bromide	D	-	-	D	D	D	-	D	Lime	-	B	-	A	-	-	-	-
Ethylene Chloride	D	A <sup>1</sup>	C	D	D	C <sup>1</sup>	-	C	Linoleic Acid	A	B	-	A	-	B <sup>1</sup>	-	B <sup>1</sup>
Ethylene Chlorohydrin	D	D	-	D	D	D	D	D	Lithium Chloride	-	A	D	A <sup>2</sup>	B <sup>1</sup>	A <sup>2</sup>	-	A <sup>1</sup>
Ethylene Diamine	D	D	B	A	A <sup>2</sup>	-	-	A	Lithium Hydroxide	-	-	D	-	D	-	-	-
Ethylene Dichloride	D	B <sup>1</sup>	D	D	D	D	D	D	Lubricants	-	A	B	D	A <sup>1</sup>	A <sup>1</sup>	-	D
Ethylene Glycol	A	B	A	A <sup>2</sup>	B <sup>1</sup>	A	A	A	Lye: KOH Potassium Hydroxide	A	A	B	A	D	A	A	C
Ethylene Oxide	D	D	B	A	C <sup>1</sup>	D	-	D	Lye: NaOH Sodium Hydroxide	C	C	B	D	D	A	A	A <sup>1</sup>
Fatty Acids	A	A	A	D	B <sup>1</sup>	A	D	C	Lye: Ca(OH) <sub>2</sub> Calcium Hydroxide	-	D	B	A <sup>2</sup>	D	A <sup>2</sup>	A	A
Ferric Chloride	A	D	D	A <sup>1</sup>	A <sup>2</sup>	A	-	B	Magnesium Bisulfate	-	-	-	-	A <sup>1</sup>	A <sup>2</sup>	-	-
Ferric Nitrate	A <sup>2</sup>	D	-	A <sup>2</sup>	A <sup>1</sup>	A	-	C	Magnesium Carbonate	B	A	-	B	A <sup>1</sup>	A	-	-
Ferric Sulfate	A <sup>2</sup>	D	-	A <sup>2</sup>	A <sup>1</sup>	A	-	B	Magnesium Chloride	B	B <sup>1</sup>	A	A <sup>1</sup>	A <sup>2</sup>	A	-	A
Ferrous Chloride	A <sup>2</sup>	D	A	A <sup>2</sup>	D	A	-	-	Magnesium Hydroxide	B	A	B	A <sup>2</sup>	A <sup>1</sup>	A	-	A
Ferrous Sulfate	A <sup>1</sup>	D	-	A <sup>2</sup>	A <sup>1</sup>	A	-	-	Magnesium Nitrate	B	A	B	A <sup>2</sup>	A <sup>1</sup>	A	-	-
Fluoboric Acid	A <sup>2</sup>	A <sup>1</sup>	A	A <sup>2</sup>	-	A	-	-	Magnesium Oxide	-	A	-	-	-	-	-	-
Fluorine	A <sup>1</sup>	D	D	D	C	D	D	D	Magnesium Sulfate (Epson Salts)	B <sup>2</sup>	B	A	A <sup>2</sup>	A <sup>1</sup>	A	-	A
Fluosilicic Acid	A <sup>2</sup>	A <sup>1</sup>	B	A <sup>2</sup>	A <sup>1</sup>	A	-	-	Maleic Acid	-	A	A	B <sup>2</sup>	-	A	-	-
Formaldehyde 40%	A <sup>2</sup>	A <sup>2</sup>	A	D	A <sup>1</sup>	A	A	-	Maleic Anhydride	-	D	A	D	-	D	-	-
Formaldehyde 100%	B	A	A	B	A <sup>2</sup>	C	A	B	Malic Acid	-	A	-	B <sup>2</sup>	-	A <sup>1</sup>	-	B
Formic Acid	D	A <sup>2</sup>	A	D	A <sup>1</sup>	A <sup>1</sup>	-	B	Manganese Sulfate	B <sup>2</sup>	A <sup>1</sup>	-	A <sup>1</sup>	A <sup>1</sup>	-	-	A <sup>1</sup>
Freon® 11	D	D	A	C	-	A	B	D	Mash	-	A	-	A	-	-	-	-
Freon® 12	A <sup>1</sup>	B	-	A <sup>1</sup>	-	A <sup>2</sup>	D	D	Mayonnaise	-	A	-	D	-	-	-	-
Freon® 22	-	A	-	-	-	B	D	D	Melamine	-	A	-	-	-	A	-	C
Freon® 113	-	A	-	-	B <sup>1</sup>	D	D	D	Mercuric Chloride (dilute)	B	B	A	A	A	B	-	-
Freon® TF	-	A	B	-	-	D	D	D	Mercuric Cyanide	B	-	-	A	-	B	-	A
Fruit Juice	B	D	-	A	-	B	-	-	Mercurous Nitrate	C <sup>2</sup>	-	-	A	A <sup>2</sup>	A	-	-
Fuel Oils	D	A	C	B	B <sup>1</sup>	A	-	D	Mercury	B	A	A	A	D	B	-	-
Furan Resin	-	D	-	D	-	D	A	D	Methane	-	A	-	-	-	A	D	D
Furfural	D	A	A	D	D	D	A	D	Methanol (Methyl Alcohol)	D	A	A	A <sup>1</sup>	B <sup>1</sup>	A <sup>2</sup>	A	A
Gallic Acid	-	B	A	A	-	A	-	D	Methyl Acetate	D	B	C	B <sup>1</sup>	D	D	-	D
Gasoline (high-aromatic)	D	-	B	A	A	A	D	D	Methyl Acetone	-	D	-	-	-	-	-	-
Gasoline, leaded, ref.	D	A	B	-	A <sup>2</sup>	B	D	D	Methyl Acrylate	-	B	-	-	-	D	D	D
Gasoline, unleaded	D	A	B	-	A <sup>2</sup>	C <sup>1</sup>	D	D	Methyl Alcohol 10%	D	A	A	A <sup>1</sup>	B <sup>1</sup>	A <sup>2</sup>	A	A
Gelatin	-	B	A	A <sup>2</sup>	-	A	-	A	Methyl Bromide	D	D	-	C <sup>1</sup>	-	C	D	-
Glucose	B	A	A	A <sup>2</sup>	A <sup>1</sup>	A	-	A	Methyl Butyl Ketone	-	D	-	-	D	D	-	D
Glue, P.V.A.	-	A	A	A <sup>1</sup>	-	-	-	A	Methyl Cellosolve	-	D	-	-	D	D	-	D
Glycerin	C	A	A	A <sup>1</sup>	A <sup>2</sup>	A	D	A	Methyl Chloride	D	B	-	C <sup>1</sup>	D	B	D	D
Glycolic Acid	B	A	-	A <sup>2</sup>	-	A	-	A	Methyl Dichloride	-	D	-	-	D	D	-	-
Gold Monocyanide	-	A	-	-	-	-	-	-	Methyl Ethyl Ketone	D	C	D	D	D	B <sup>2</sup>	D	D
Grape Juice	B	A	-	B	-	-	-	A	Methyl Ethyl Ketone Peroxide	-	-	-	-	-	-	-	B
Grease	-	D	-	-	-	-	-	D	Methyl Isobutyl Ketone	D	-	D	C	D	A	D	D
Heptane	D	A	B	B <sup>1</sup>	B	C <sup>2</sup>	A	D	Methyl Isopropyl Ketone	-	-	-	D	D	-	-	C
Hexane	D	A	C	D	D	B <sup>1</sup>	A	D	Methyl Methacrylate	-	D	-	-	-	D	C	C
Honey	-	A	-	B	A <sup>1</sup>	A	-	A	Methylamine	D	D	-	A <sup>1</sup>	-	A <sup>2</sup>	-	-
Hydraulic Oil (Petro)	-	B	A	C	-	D	B	B	Methylene Chloride	D	B	D	D	D	B <sup>1</sup>	D	-
Hydraulic Oil (Synthetic)	-	-	A	A	-	D	D	B	Milk	B	A	-	A	A	B	-	A
Hydrazine	-	B	D	-	D	C	-	B	Mineral Sprirts	D	A	D	B	C	B	-	D
Hydrobromic Acid 20%	-	C	D	B <sup>2</sup>	-	A <sup>2</sup>	-	D	Molasses	B	A	A	A	-	B	-	-
Hydrobromic Acid 100%	B	D	D	B <sup>1</sup>	-	C <sup>1</sup>	-	D	Monochloroacetic Acid	-	D	D	-	D	-	D	-
Hydrochloric Acid 20%	A	C	A	A <sup>2</sup>	B <sup>1</sup>	B <sup>2</sup>	A	D	Monoethanolamine	-	D	-	C	-	B	-	B
Hydrochloric Acid 37%	A	C	A	B <sup>2</sup>	D	C	A	B	Morpholine	C	-	-	-	D	B <sup>2</sup>	-	-
Hydrochloric Acid 100%	A	C	D	-	D	B <sup>1</sup>	A	D	Motor Oil	C	B	-	C <sup>1</sup>	A	A	-	-
Hydrochloric Acid, Dry Gas	-	-	D	A <sup>2</sup>	-	B	A	-	Mustard	B	C	-	A	A	A	-	-
Hydrocyanic Acid	B	B	A	A <sup>2</sup>	-	A	A	C	Naphtha	D	A <sup>1</sup>	-	A <sup>1</sup>	B	B	D	D
Hydrocyanic Acid (Gas 10%)	-	C	A	-	B <sup>1</sup>	A	A	D	Naphthalene	D	A <sup>1</sup>	B	C	-	B	D	D
Hydrofluoric Acid 20%	C	D	A	A <sup>2</sup>	D	A <sup>2</sup>	D	D	Natural Gas	B	B	-	A	-	A	D	A
Hydrofluoric Acid 50%	C	D	A	A <sup>1</sup>	D	A <sup>2</sup>	D	D	Nickel Chloride	A	A	B	A	A <sup>2</sup>	A	-	A

# Chemical Resistance Chart

Reagent	ABS	Acetal	HDPE	LDPE	PC	PP	Santo-prene	Sili-cone	Reagent	ABS	Acetal	HDPE	LDPE	PC	PP	Santo-prene	Sili-cone
Nickel Nitrate	A	-	B	A	D	A2	-	-	- Barrel Chrome Bath 95°F	-	D	-	-	-	A	-	-
Nickel Sulfate	B	A	B	A	A	A	-	A	- Black Chrome Bath 115°F	-	D	-	-	-	A	-	-
Nitrating Acid (<1% Acid)	-	-	-	-	-	C	-	-	- Chromic-Sulfuric Bath 130°F	-	D	-	-	-	A	-	-
Nitrating Acid (<15% H <sub>2</sub> SO <sub>4</sub> )	-	-	-	-	-	C	-	-	- Fluoride Bath 130°F	-	D	-	-	-	A	-	-
Nitrating Acid (>15% H <sub>2</sub> SO <sub>4</sub> )	-	D	-	-	-	C	-	-	- Fluosilicate Bath 95°F	-	D	-	-	-	D	-	-
Nitrating Acid (<15% HNO <sub>3</sub> )	-	-	-	-	-	C	-	-	- Copper Plating (Cyanide):	-	A	-	-	-	A	-	-
Nitric Acid (5-10%)	B	D	A	B	A	A	D	C	- Cooper Strike Bath 120°F	-	A	-	-	-	A	-	-
Nitric Acid (20%)	B	D	B	C	B'	A <sup>2</sup>	D	D	- High-Speed Bath 180°F	-	B	-	-	-	A	-	-
Nitric Acid (50%)	C	D	D	B'	B	B	D	D	- Rochelle Salt Bath 150°F	-	B	-	-	-	A	-	-
Nitric Acid (Concentrated)	D	D	D	C'	C'	D	D	D	- Copper Plating (Acid):	-	C	-	-	-	A	-	-
Nitrobenzene	D	C	D	C'	D	B'	-	D	- Copper Fluoborate Bath 120°F	-	A	-	-	-	A	-	-
Nitrogen Fertilizer	D	-	-	-	-	-	-	-	- Copper Sulfate Bath R.T.	-	A	-	-	-	A	-	-
Nitromethane	D	A	D	A	D	B <sup>2</sup>	-	D	- Copper Plating (Misc):	-	A	-	-	-	A	-	-
Nitrous Acid	D	-	-	-	-	A	-	-	- Copper Pyrophosphate	-	D	-	-	-	A	-	-
Nitrous Oxide	-	-	-	C	-	D	-	-	- Copper (Electroless)	-	D	-	-	-	A	-	-
Oils:									- Gold Plating:								
- Aniline	D	D	-	-	-	A	-	D	- Acid 75°F	-	-	-	-	-	A	-	-
- Anise	-	D	-	-	-	-	-	-	- Cyanide 150°F	-	-	-	-	-	A	-	-
- Bay	-	D	-	-	-	-	-	-	- Neutral 75°F	-	-	-	-	-	A	-	-
- Bone	-	D	-	-	-	A	-	-	- Indium Sulfamate Plating R.T.	-	-	-	-	-	A	-	-
- Cinnamon	-	D	D	D	D	D	-	-	- Castor	A	A	-	-	-	A	-	A
- Citric	D	A	-	A	A	A	-	-	- Iron Plating:								
- Clove	-	-	-	-	-	-	-	-	- Ferrous Am Sulfate Bath 150°F	-	-	-	-	-	A	-	-
- Coconut	A	A	-	A	-	A'	-	A	- Ferrous Chloride Bath 190°F	-	-	-	-	-	C	-	-
- Cod Liver	A	B	-	-	-	A'	-	B	- Ferrous Sulfate Bath 150°F	-	-	-	-	-	A	-	-
- Corn	B	A	-	A	-	A <sup>2</sup>	-	A	- Fluoborate Bath 145°F	-	-	-	-	-	A	-	-
- Cottonseed	A	A	-	A	-	A	-	A	- Sulfamate 140°F	-	-	-	-	-	A	-	-
- Creosote	-	D	-	C	-	C	-	D	- Sulfate-Chloride Bath 160°F	-	-	-	-	-	A	-	-
- Crude Oil	A	A	D	-	-	A	-	-	Plating Solutions, continued								
- Diesel Fuel (20, 30, 40, 50)	-	D	-	A	-	A'	-	D	- Lead Fluoborate Plating	-	-	-	-	-	A	-	-
- Fuel (1, 2, 3, 5A, 5B, 6)	D	D	-	B	B	B	-	C	- Nickel Plating:								
- Ginger	-	A	-	-	-	-	-	-	- Electroless 200°F	-	-	-	-	-	D	-	-
- Hydraulic Oil (Petro)	-	B	-	C	-	D	-	B	- Fluoborate 100-170°F	-	-	-	-	-	A	-	-
- Hydraulic Oil (Synthetic)	-	-	-	A	-	D	-	B	- High-Chloride 130-140°F	-	-	-	-	-	A	-	-
- Lemon	C	D	-	-	-	-	-	-	- Watts Type 115-160°F	-	-	-	-	-	A	-	-
- Linseed	-	A	-	A	-	A	-	A	- Rhodium Plating 120°F	-	-	-	-	-	A	-	-
- Mineral	A	A	A	B'	B	A	-	C	- Silver Plating 80-120°F	-	-	-	-	-	A	-	-
- Olive	A	A	A	A'	A <sup>2</sup>	A	-	D	- Tin-Fluoborate Plating 100°F	-	-	-	-	-	A	-	-
- Orange	-	D	C	C'	A	A	-	D	- Tin-Lead Plating 100°F	-	-	-	-	-	A	-	-
- Palm	A	A	-	A	-	-	-	-	- Zinc Plating:								
- Peanut	-	A	-	A	-	D	-	A	- Acid Chloride 140°F	-	-	-	-	-	A	-	-
- Peppermint	D	D	-	-	-	-	-	-	- Acid Fluoborate Bath R.T.	-	-	-	-	-	A	-	-
- Pine	D	A	B	D	A	B	-	D	- Acid Sulfate Bath 150°F	-	-	-	-	-	A	-	-
- Rapeseed	-	A	-	D	-	D	-	D	- Alkaline Cyanide Bath R.T.	-	-	-	-	-	A	-	-
- Rosin	-	-	-	B <sup>2</sup>	-	A <sup>2</sup>	-	-	Potash (Potassium Carbonate)	A	B	B	A'	-	A	-	-
- Sesame Seed	A	D	-	-	-	A	-	-	Potassium Bicarbonate	A	-	B	A	-	A	-	A'
- Silicone	A	A	A	A	-	A	-	C	Potassium Bromide	A'	A	B	A	A'	A	-	A'
- Soybean	A	A	-	A'	-	A'	-	A	Potassium Chlorate	A	B	B	A'	A'	A	-	B
- Sperm (whale)	A	D	-	-	-	-	-	-	Potassium Chloride	A	A	A	A'	A	A	-	A
- Tanning	-	D	-	-	-	-	-	-	Potassium Chromate	-	C	-	A	-	A	-	-
- Transformer	-	A	-	C'	-	B	-	B	Potassium Cyanide Solutions	A	C	-	A	-	A	-	A
- Turbine	-	A	-	C	-	B'	-	D	Potassium Dichromate	B'	A	B	A	A'	A	-	A
Oleic Acid	D	A	C	C <sup>2</sup>	-	B'	-	D	Potassium Ferricyanide	B	B'	-	A <sup>2</sup>	-	A <sup>2</sup>	-	-
Oleum 25%	-	D	-	D	-	D	-	D	Potassium Ferrocyanide	-	-	-	A'	-	A	-	-
Oleum 100%	D	D	-	D	-	D	-	D	Potassium Hydroxide (Caustic Potash)	A	A	A	A	D	A	B	C
Oxalic Acid (cold)	A	B	A	A <sup>2</sup>	-	A <sup>2</sup>	A	B	Potassium Hypochlorite	-	-	-	C'	-	-	-	-
Ozone	B	C	A	C'	A'	B	D	A	Potassium Iodide	B	-	B	B'	-	A <sup>2</sup>	-	-
Palmitic Acid	A	A	-	-	-	B'	A	D	Potassium Nitrate	B	A	B	A	A'	A	-	A
Paraffin	A	A	B	B	A'	A'	-	D	Potassium Oxalate	-	-	-	-	-	-	-	-
Pentane	-	B	-	D	A	D	B	D	Potassium Permanganate	B'	A	A	A	A <sup>2</sup>	A'	-	-
Perchloric Acid	-	C	D	B	-	C	D	D	Potassium Sulfate	B	B	B	A <sup>2</sup>	A'	A	-	A
Perchloroethylene	D	B	D	D	D	D	D	D	Potassium Sulfide	B	-	-	-	-	A	-	-
Petrolatum	-	B	-	B	-	D	-	D	Propane (liquefied)	-	A	D	C'	C'	A	-	D
Petroleum	B	B	D	C'	-	B'	C	D	Propylene	B	-	-	-	-	-	-	D
Phenol (10%)	D	B	D	B	B'	B'	D	D	Propylene Glycol	B	B	A	B <sup>2</sup>	B'	A <sup>2</sup>	-	A
Phenol (Carbolic Acid)	D	D	D	D	D	B	-	D	Pyridine	-	B	D	B'	D	A <sup>2</sup>	A	D
Phosphoric Acid (<40%)	B	D	A	A	A	A <sup>2</sup>	A	C	Pyrogalllic Acid	-	D	-	-	-	A	D	-
Phosphoric Acid (>40%)	C	D	A	B'	A	A <sup>2</sup>	C	D	Resorcinol	A	-	-	B <sup>2</sup>	B'	A <sup>2</sup>	-	-
Phosphoric Acid (crude)	C	D	B	B'	A	B <sup>2</sup>	-	D	Rosins	-	B	B	B'	-	A <sup>2</sup>	-	A
Phosphoric Acid (molten)	D	D	D	-	-	D	-	-	Rum	-	A	-	-	-	A	-	A
Phosphoric Acid Anhydride	-	D	A	-	D	A	-	-	Rust Inhibitors	-	A	-	-	-	A	-	-
Phosphorus	-	B	-	B	-	A	-	-	Salad Dressing	-	A	-	-	-	A	-	-
Phosphorus Trichloride	D	D	A	B	C	-	-	-	Salicylic Acid	A	D	-	B <sup>2</sup>	A'	A'	-	-
Photographic Developer	B	D	-	A	A <sup>2</sup>	A	-	B	Salt Brine (NaCl saturated)	-	-	A	A	A	A	A	A'
Photographic Solutions	-	D	A	A	A'	A <sup>2</sup>	-	A	Sea Water	-	A	A	A <sup>2</sup>	A <sup>2</sup>	A	A	A'
Phthalic Acid	B	C	B	B <sup>2</sup>	A	-	B'	-	Shellac (Bleached)	-	A	-	A'	-	A	-	-
Phthalic Anhydride	B	C	-	-	A'	D	-	-	Shellac (Orange)	-	A	-	A'	-	A	-	-
Picric Acid	A	A	D	A	D	B'	D	D	Silicone	D	A	-	-	A <sup>2</sup>	A	-	C
Plating Solutions									Silver Bromide	-	C	-	A	-	-	-	-
- Antimony Plating 130°F	-	A	-	-	-	A	-	-	Silver Nitrate	B	A	A	A	A <sup>2</sup>	A'	-	A
- Arsenic Plating 110°F	-	A	-	-	-	A	-	-	Soap Solutions	A	A	B	D	A'	A	A	A
- Brass Plating:									Soda Ash (see Sodium Carbonate)	B	A	A	B	A	A	-	A
- Regular Brass Bath 100°F	-	A	-	B	-	A	-	-	Sodium Acetate	B	B	A	A	A'	A	-	D
- High-Speed Brass Bath 110°F	-	A	-	B	-	A	-	-	Sodium Aluminate	-	B	-	-	-	-	-	-
- Bronze Plating:									Sodium Benzoate	A	-	B	A <sup>2</sup>	A <sup>2</sup>	A <sup>2</sup>	-	-
- Cu-Cd Bronze Bath R.T.	-	A	-	-	-	A	-	-	Sodium Bicarbonate	A	A	A	A <sup>2</sup>	A <sup>2</sup>	A	-	A
- Cu-Sn Bronze Bath 160°F	-	B	-	-	-	A	-	-	Sodium Bisulfate	A	B	B	A <sup>2</sup>	A'	A	-	A
- Cu-Zn Bronze Bath 100°F	-	A	-	-	-	A	-	-									
- Cadmium Plating:																	
- Cyanide Bath 90°F	-	A	-	-	-	A	-	-									
- Fluoborate Bath 100°F	-	C	-	-	-	A	-	-									
- Chromium Plating:																	



# Chemical Resistance Chart

Reagent	ABS	Acetal	HDPE	LDPE	PC	PP	Santo-prene	Sili-cone	Reagent	ABS	Acetal	HDPE	LDPE	PC	PP	Santo-prene	Sili-cone
Sodium Bisulfite	A	C	B	A <sup>2</sup>	A <sup>1</sup>	A	-	A	Sulfuric Acid (10-75%)	B	D	A	A <sup>1</sup>	B <sup>1</sup>	A <sup>1</sup>	B	D
Sodium Borate (Borax)	A	-	B	A <sup>2</sup>	A <sup>1</sup>	A <sup>2</sup>	-	A	Sulfuric Acid (75-100%)	-	-	B	C	D	C <sup>1</sup>	D	D
Sodium Bromide	B	A	-	A <sup>2</sup>	-	-	-	-	Sulfuric Scid (cold concentrated)	-	-	B	D	-	A <sup>2</sup>	D	D
Sodium Carbonate	B	A <sup>1</sup>	A	B <sup>2</sup>	A <sup>2</sup>	A	-	A	Sulfuric Acid (hot concentrated)	-	-	B	D	D	D	D	D
Sodium Chlorate	A	A	-	B <sup>2</sup>	A <sup>1</sup>	A	-	C	Sulfurous Acid	-	C	B	B <sup>2</sup>	-	A	-	D
Sodium Chloride	A	A <sup>1</sup>	A	A <sup>2</sup>	A <sup>2</sup>	A	A	A	Sulfuryl Chloride	-	A	-	-	-	-	-	-
Sodium Chromate	-	D	-	-	A <sup>2</sup>	-	-	-	Tallow	-	A	A	C	-	A <sup>2</sup>	-	-
Sodium Cyanide	A	A	B	A <sup>2</sup>	-	A	-	A	Tannic Acid	-	B	A	B <sup>2</sup>	C	A	A	B
Sodium Ferrocyanide	-	A	-	A	-	A	-	-	Tanning Liquors	-	B	-	A <sup>1</sup>	-	A <sup>1</sup>	-	B
Sodium Fluoride	A	-	-	A <sup>2</sup>	-	A	-	-	Tartaric Acid	-	B	A	A <sup>1</sup>	-	A	A	A
Sodium Hydrosulfite	-	-	-	-	-	-	-	C	Tetrachloroethane	-	A	-	-	-	C	D	D
Sodium Hydroxide (20%)	B	A	C	B	A <sup>2</sup>	A	A	A <sup>2</sup>	Tetrachloroethylene	-	A	C	B	D	D	D	D
Sodium Hydroxide (50%)	A	A	C	B	D	A	A	A <sup>1</sup>	Tetrahydrofuran	-	A	C	C <sup>1</sup>	D	C <sup>2</sup>	D	D
Sodium Hydroxide (80%)	A	D	C	-	D	A	C	A <sup>1</sup>	Tin Salts	-	-	-	-	A	-	-	B
Sodium Hypochlorite (100%)	-	D	C	B <sup>2</sup>	-	B	D	B	Toluene (Toluol)	D	C <sup>1</sup>	D	C <sup>1</sup>	D	C <sup>1</sup>	D	D
Sodium Hypochlorite (<20%)	B	D	A	A	C	A	A	B	Tomato Juice	B	B	A	A <sup>1</sup>	A <sup>1</sup>	A	-	-
Sodium Hyposulfate	-	-	-	-	-	-	-	-	Trichloroacetic Acid	-	-	C	A	D	A	-	D
Sodium Metaphosphate	-	B	B	A <sup>1</sup>	-	A <sup>1</sup>	-	A	Trichloroethane	-	A	D	-	D	C	D	D
Sodium Metasilicate	-	D	-	-	-	A	-	-	Trichloroethylene	D	D	D	D	-	C <sup>1</sup>	D	D
Sodium Nitrate	-	A	B	A <sup>2</sup>	-	A	-	D	Trichloropropane	D	A	-	-	-	-	-	-
Sodium Perborate	-	B	-	A <sup>1</sup>	-	A	-	B	Tricresylphosphate	B	C	-	B <sup>1</sup>	-	A <sup>1</sup>	-	C
Sodium Peroxide	-	D	B	A	A <sup>2</sup>	B	-	D	Triethylamine	-	D	-	-	-	D	-	-
Sodium Polyphosphate	-	B	B	A	-	A	-	D	Trisodium Phosphate	B <sup>1</sup>	A	A	A	-	A	-	A
Sodium Silicate	-	C	A	A <sup>2</sup>	-	A	-	A	Turpentine	D	A <sup>2</sup>	B	D	D	D	D	D
Sodium Sulfate	-	B	-	A <sup>2</sup>	A <sup>2</sup>	A	-	A	Urea	B	A	A	A	D	A	-	B
Sodium Sulfide	-	B	B	A <sup>2</sup>	D	A	-	A	Uric Acid	-	-	-	B	-	-	A	-
Sodium Sulfite	-	-	B	B <sup>1</sup>	-	A <sup>2</sup>	-	A	Urine	-	A	A	A <sup>2</sup>	-	A	-	-
Sodium Tetraborate	-	B	-	A <sup>2</sup>	-	-	-	A	Varnish	-	A	B	A	-	A	-	D
Sodium Thiosulfate (hypo)	-	C <sup>1</sup>	-	A <sup>1</sup>	D	A <sup>2</sup>	-	A	Vegetable Juice	B	A	-	-	-	-	-	B
Sorghum	-	A	-	-	-	-	-	-	Vinegar	A	B	A	A	A <sup>2</sup>	A	-	A
Soy Sauce	-	A	-	-	-	-	-	-	Vinyl Acetate	-	-	D	A	-	B <sup>1</sup>	-	D
Stannic Chloride	-	C	-	A <sup>2</sup>	A <sup>1</sup>	A	-	B	Vinyl Chloride	D	-	-	-	-	-	-	-
Stannic Fluoborate	-	C	-	-	-	-	-	-	Water, Deionized	-	-	A	-	-	A <sup>2</sup>	A	-
Stannous Chloride	-	-	-	B <sup>2</sup>	-	A	-	B	Water, Acid, Mine	B	A <sup>1</sup>	A	A <sup>2</sup>	B <sup>2</sup>	A	A	B
Starch	-	A	-	B	-	A <sup>2</sup>	-	-	Water, Distilled	B	B	A	A <sup>2</sup>	A <sup>2</sup>	A	A	C
Stearic Acid	-	A	A	B <sup>1</sup>	A <sup>1</sup>	A <sup>2</sup>	A	B	Water, Fresh	A	A <sup>2</sup>	A	A <sup>2</sup>	A <sup>2</sup>	A	A	B
Stoddard Solvent	B	A	-	C <sup>2</sup>	A <sup>2</sup>	C	D	D	Water, Salt	-	A	A	A <sup>2</sup>	A <sup>2</sup>	A	A	B
Styrene	-	A	-	-	D	-	-	D	Weed Killers	-	A	-	-	-	-	-	A
Sugar (Liquids)	B	A	-	-	-	A	-	A	Whey	-	A	-	-	-	-	-	-
Sulfate (Liquors)	-	D	A	A <sup>2</sup>	-	A	-	B	Whiskey and Wines	C	A	B	C	A <sup>1</sup>	A	-	A
Sulfur Chloride	-	D	-	C <sup>1</sup>	-	C <sup>1</sup>	-	C	White Liquors (Pulp Mill)	-	D	-	A <sup>2</sup>	-	A <sup>1</sup>	-	A
Sulfur Dioxide	D	B	D	B <sup>1</sup>	-	A <sup>1</sup>	-	B	White Water (Paper Mill)	-	B	-	-	-	A	-	-
Sulfur Dioxide (dry)	-	B	A	A <sup>1</sup>	A <sup>1</sup>	A <sup>1</sup>	-	B	Xylene	D	A	D	B	D	B	D	D
Sulfur Hexafluoride	-	-	-	B	-	-	-	B	Zinc Chloride	A	C	A	A <sup>1</sup>	A <sup>2</sup>	A	B	B
Sulfur Trioxide	-	-	-	-	-	C	-	B	Zinc Hydrosulfite	A	C	-	-	-	-	-	-
Sulfur Trioxide (dry)	-	D	-	C <sup>1</sup>	-	D	-	B	Zinc Sulfate	A	C	A	A <sup>2</sup>	A <sup>2</sup>	A	-	A
Sulfuric Acid (<10%)	B	D	A	A <sup>1</sup>	A <sup>1</sup>	A <sup>2</sup>	A	C									

- A - No effect
- B - Minor effect
- C - Moderate effect
- D - Severe effect; not recommended
- No data available

**Explanation of footnotes:**

- 1 - Satisfactory to 72 °F (22 °C)
- 2 - Satisfactory to 120 °F (48 °C)
- 3 - Satisfactory to 90 °F (32 °C)
- 4 - Satisfactory to 200 °F (93 °C)

# Trademarks of Simport



Cryovial  
Dropette  
Histosette

Macrosette  
Micrewtube  
Urisafe

# TM

AmPlate  
AmpliTube  
BioBlock  
BioDisposer  
BioTube  
CapInsert  
ChillBlock  
ClikLock  
Combi-Box  
Combi-Rack  
CoreDish  
CombiStore  
CorePicker  
CryoLock  
CryoStore  
CulTubes  
CytoSep  
DissecTable  
DispoCut  
DrainRack  
EasyDip  
EconoTube

EcoTainer 24  
Ez-Load  
FitsAll  
FlexTainer  
HistoTainer  
HydroTainer  
Ino-Loop  
Jumbosette  
LockMailer  
MicrewLock  
Micromesh  
Microsette  
MultiRack  
OneHand  
PCRRack  
Pierce-It  
Q-Swab  
QuickLoad  
SecuRack  
Secure-Lock  
SecureSeal  
SecurTainer

SeraNest  
SimFoil  
SimPlate  
SlideFile  
SlideFolder  
SlideTray  
Slimsette  
Snaptwist  
SputEm  
StainTray  
StoreBox  
Swingsette  
Tricorn  
UniMailer  
UniRack  
Unisette  
UriTainer  
VacuCap  
Write-On

PCR (Polymerase Chain Reaction) patents are owned by Hoffman-La-Roche Inc., Nutley, NJ

CoreTainer is a registered trademark of Beekley Corporation  
Cytospin is a registered trademark of Shandon Lipshaw

Cyto-Tek is a registered trademark of Miles Corporation  
Cytopro is a registered trademark of Wescor Inc.  
Cytofuge is a registered trademark of Norfolk Scientific Inc.





# Simport<sup>®</sup>

*A Family Owned Company Since 1975*

**Simport products  
are available  
through distributors  
around the world**



[www.simport.com](http://www.simport.com)



MJS  
**BioLynx**  
INC.

1-888-593-5969 • [www.biolynx.ca](http://www.biolynx.ca) • [tech@biolynx.ca](mailto:tech@biolynx.ca)